

KATALOG PRODUKTÓW 'WP'
'WP' PRODUCT CATALOGUE / КАТАЛОГ ТОВАРОВ 'WP'

2017/2018



Pomimo wielu starań, aby nasz katalog był bardzo dokładny, nie ponosimy żadnej odpowiedzialności za ewentualne błędy w nim zawarte. Zastrzegamy sobie prawo do dokonywania zmian w specyfikacji technicznej bez wcześniejszego powiadomienia. Wszelkie powiązania referencji z częściami oryginalnymi są zamieszczone wyłącznie w celach identyfikacji. Wszystkie prezentowane w katalogu przewody domyślnie są produkowane z miedzi. Na życzenie klienta każdy z nich może zostać wykonany ze stali bądź miedzi-niklu.

UWAGA

Przedsiębiorstwo „WP” Bożena Pniewska jest niezależnym producentem części zamiennych do samochodów. Nazwy marek samochodów, do których pasują części zamienne objęte tym katalogiem, podawane są w katalogu wyłącznie w celu wskazania przeznaczenia części zgodnie z:

- art. 156 ust. 1 pkt 3 ustawy z dnia 30 czerwca 2000 r. prawo własności przemysłowej,
- art. 6 ust. 1 lit. c dyrektywy Parlamentu Europejskiego i Rady 2008/95/WE z dnia 22 października 2008 r. mającej na celu zbliżenie ustawodawstw państw członkowskich odnoszących się do znaków towarowych,
- art. 12 lit. c rozporządzenia Rady (WE) nr 207/2009 z dnia 26 lutego 2009 r. w sprawie wspólnotowego znaku towarowego oraz
- art. 17 Porozumienia w sprawie handlowych aspektów praw własności intelektualnej z dnia 15 kwietnia 1994 r. (TRIPS).

Zawarte w niniejszym katalogu odwołania do marek samochodów nie sugerują istnienia jakichkolwiek powiązań prawnych lub organizacyjnych między Przedsiębiorstwem „WP” a producentami poszczególnych marek samochodów. Związki takie nie istnieją.

CATALOGUE UPDATED ON 02.01.2017
11th EDITION FOR YEARS 2017/2018

Despite our greatest effort we have provided to keep our catalogue very accurate, we shall take any responsibility for errors occurred. At the same time we do reserve the right to introduce changes into the technical specification without further notice. All references related to the original parts and numbers are presented only for identification purposes. All brake lines presented in this catalogue are produced of copper as default material. There is a possibility to manufacture them out of steel (in PVF coating) or copper-nickel upon customers' request.

IMPORTANT NOTICE:

“WP” Company is an independent manufacturer of spare parts for cars. Car brands, corresponding to spare parts covered by this catalogue, are specified only as the indication of spare parts' usage according to:

- art. 156, par. 1, item 3 of the Act of 30.06.2000 on Industrial Property Law,
- art. 6, par. 1, point. c of the European Parliament and of the Council 2008/95/EC of 22.10.2008 introduced to align legislation of the EU members relating to trade marks,
- art. 12, point c, Council Regulation (EC) No 207/2009 of 26.02.2009 relating to the Community Trade Mark and
- art. 17 of the Agreement on Trade Related Aspects of Intellectual Property Rights of 15.04.1994 (TRIPS).

References to car brands in this catalogue do not imply the existence of any legal or organizational connections between “WP” Company and producers of individual car brands. Such connections do not exist.

КАТАЛОГ ОБНОВЛЕН 02.01.2017
ИЗДАНИЕ XI НА 2017/2018 ГОД

Мы приложили все усилия, чтобы наш каталог был максимально точным, но не несем какой-либо ответственности за возможные ошибки. Мы оставляем за собой право вносить изменения в техническую спецификацию без предварительного уведомления. Все ссылки на оригинальные детали размещены исключительно с целью идентификации. Все представленные в каталоге трубки по умолчанию изготавливаются из меди. Любую из них можно изготовить из стали или медно-никелевого сплава.

ВНИМАНИЕ

Предприятие «WP» Боżена Пневска является независимым производителем запчастей к автомобилям. Названия марок автомобилей, к которым подходят запчасти, включенные в этот каталог, приводятся исключительно для указания назначения детали в соответствии с:

- ст. 156 п. 1 пп. 3 закона о промышленной собственности от 30 июня 2000 г,
- ст. 6 п. 1 лит. с Директивой Европейского Парламента и Совета № 008/95/ЕС от 22 октября 2008 г. о сближении законодательств государств-членов в отношении товарных знаков и знаков обслуживания,
- ст. 12 лит. с Постановления Совета (ЕС) № 207/2009 от 26 февраля 2009 г. О товарном знаке Сообщества, а также
- ст. 17 Соглашения по торговым аспектам прав интеллектуальной собственности (TRIPS) от 15 апреля 1994 г.

Содержащиеся в настоящем каталоге ссылки на названия марок автомобилей не указывают на какие-либо правовые или организационные связи Предприятия «WP» с производителями моделей автомобилей. Таких связей не существует.



Wydawca :

Przedsiębiorstwo “WP”
ul. Miedziana 8
05-830 Kajetany
Poland

2	Mapa dojazdu Location / Карта проезда
3	Wstęp Introduction / Вступление
4	Certyfikaty Certificates / Сертификаты
6	Identyfikacja przewodów hamulcowych Brake lines identification / Идентификация тормозных трубок
7	Pakowanie przewodów hamulcowych Brake lines packing / Упаковка тормозных трубок
8	Rodzaje spęceń Flare types / Виды вальцовок
9	Lokalizacja przewodu hamulcowego Brake line location / Местоположение тормозного трубки
11	Przewody hamulcowe sortowane wg marek i modeli Brake lines sorted by brand and model / Тормозные трубки по марке и модели автомобиля
135	Zestawy przewodów hamulcowych Brake lines sets / Наборы тормозных трубок
145	Rurka hamulcowa w zwojach Brake tube in coils / Тормозная трубка в бухтах
151	Drobne elementy układu hamulcowego Small parts of braking system / Мелкие детали тормозной системы
167	Specjalistyczne narzędzia Special tools / Приборы
177	Rozpieracze, samoregulatory Adjusters, selfregulators / Саморегулирующиеся и распорные планки
189	Błaszki do rozpieraczy Adjuster levers / Пластинки для распорных планок
197	Przewody hamulcowe sortowane według indeksu „WP” Brake lines sorted by „WP” index / Выбор тормозных трубок по коду WP
211	Przewody hamulcowe sortowane według złączy i długości Brake lines sorted by fittings and lengths / Выбор тормозных трубок по длине трубки и наконечникам

Mapa dojazdu

Location / Карта проезда

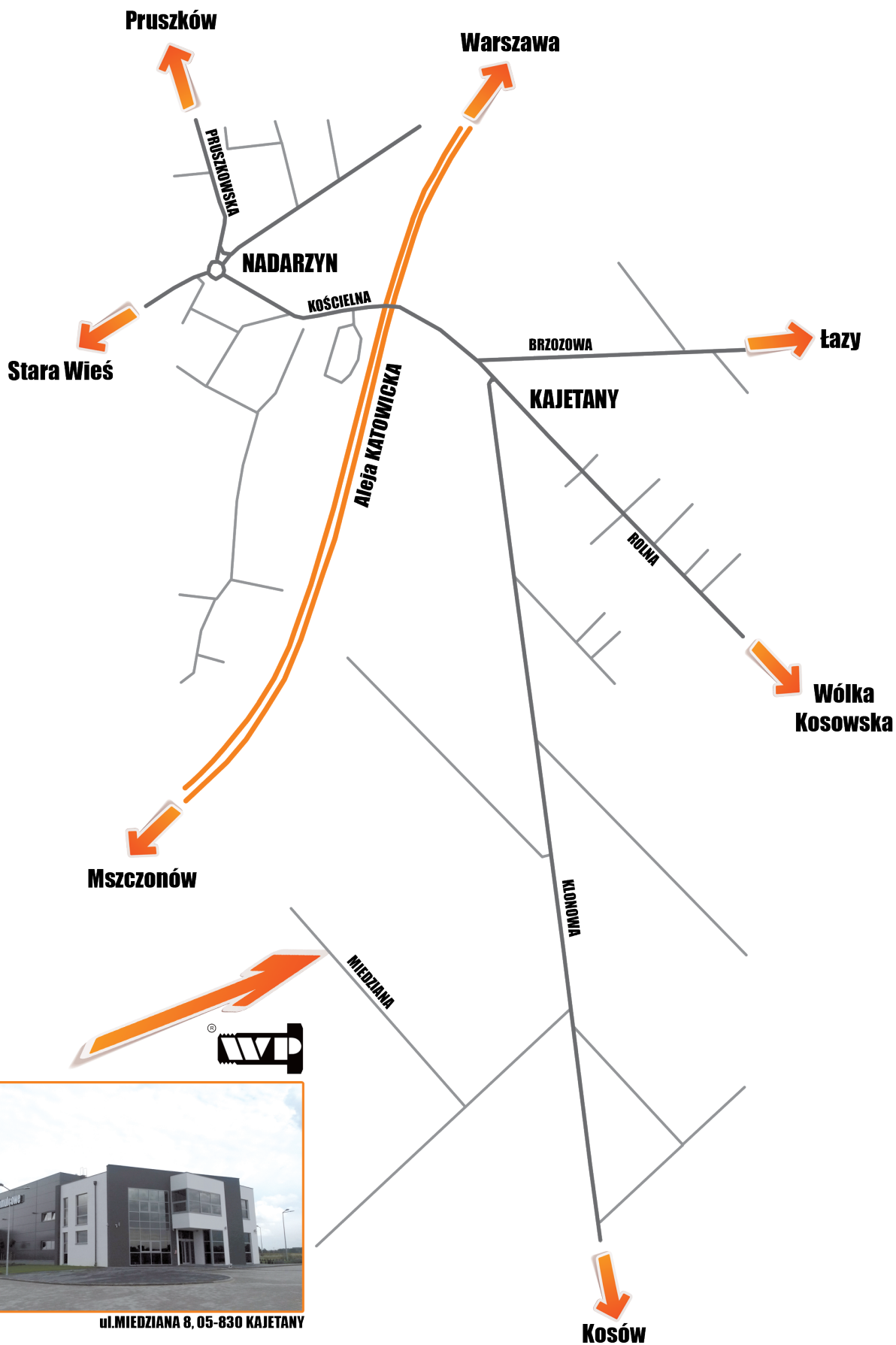

ul.MIEDZIANA 8, 05-830 KAJETANY

Szanowni Państwo,

Przedsiębiorstwo „WP” od niemal 40 lat swojej historii jest producentem sztywnych przewodów hamulcowych. Dzięki temu doświadczeniu opracowaliśmy technologię i stworzyliśmy proces produkcyjny, który pozwala na wytwarzanie wysokiej jakości przewodów z odpowiednio dostosowanych rur miedzianych, miedziano-niklowych oraz stalowych w powłoce PVF. Stosowane przez nas rury pochodzą od sprawdzonych dostawców, z którymi długoletnia, ścisła współpraca zaowocowała bardzo dobrą jakością surowca.

Potwierdzeniem wysokiej jakości naszych wyrobów jest ich niezawodność.

Przewody „WP” są oferowane – w zależności od indywidualnych wymagań Klientów – w odcinkach prostych lub wyprofilowanych do wybranych modeli samochodów. Ponadto w naszym asortymencie można również znaleźć dużą liczbę drobnych elementów układu hamulcowego takich, jak: złączki, łączniki, redukcje, trójniki, odpowietrzniki, rozpieracze i samoregulatory. Sprzedajemy także rurkę hamulcową w zwojach wraz z zestawami złączek oraz narzędziami, które umożliwiają samodzielne dorobienie gotowego przewodu hamulcowego do dowolnego modelu auta.

W celu zapewnienia łatwej identyfikacji producenta oraz partii produkcyjnej każdy przewód hamulcowy pochodzący z naszej firmy jest oznaczony specjalnym nadrukiem, który jednocześnie chroni nasze produkty przed fałszowaniem.

Aby ułatwić Państwu znalezienie i dobór elementów z naszej oferty, przygotowaliśmy niniejszy katalog produktów WP. Powstał on dzięki wieloletniej współpracy z naszymi Klientami i został dostosowywany do ich potrzeb, aby stać się dokumentem czytelnym i użytecznym.

Życzę bezpiecznego użytkowania pojazdów z produktami WP!

Dear Sirs,

For nearly 40 years of its history, „WP” Company has been the rigid brake lines manufacturer. Having such experience we have developed the technology and created the production process that results in manufacture of high quality brake lines using properly customized copper and copper-nickel lines as well as steel lines in PVF coating. As all tubes come from reliable suppliers, our common and long-time co-operation has resulted in very good quality of raw materials.

Reliability of our products is the confirmation of their highest quality.

Depending on customers' individual requirements, „WP” brake lines are offered as straight parts as well as profiled, for certain car brands. Our product range also includes various number of braking system elements, such as: fittings, connectors, reducers, t-connectors, bleeder screws, brake adjusters and adjuster levers. We also offer brake tubes in coils, along with fitting sets and hand tools for unassisted performance of brake lines flares for any car brand.

In order to secure the full identification of the manufacturer and production batch, we mark all our brake lines with special overprint which additionally protects our products from falsification.

To help you with finding and matching our offer's elements, we have prepared this WP products catalogue. It's been created through years of co-operation with our Customers, adapted to their needs, to eventually become a clear and useful guidance document.

Have a safe use of vehicles with „WP” products!

Уважаемые господа!

Предприятие «WP» уже почти 40 лет своей истории производит тормозные трубки. Благодаря этому опыту мы разработали технологию и наладили производственный процесс, который гарантирует изготовление высококачественных трубок из соответствующим образом подготовленных медных, медно-никелевых и стальных трубок в оболочке PVF. Используемые нами трубки нам поставляют проверенные поставщики, с которыми мы плотно сотрудничаем уже много лет. Это позволяет получать сырье очень хорошего качества.

Подтверждением высокого качества наших изделий является их надежность.

В зависимости от требований клиентов трубки «WP» поставляются в виде прямых отрезков или профилированных для конкретных моделей автомобилей. Кроме того, в нашем ассортименте также представлено большое количество мелких деталей тормозной системы: наконечники, соединители, переходники, тройники, штуцеры, тормозные кулаки и саморегуляторы. Мы также продаем тормозные трубки в рулонах в комплекте с набором наконечников и инструментами, которые позволяют самостоятельно сделать тормозную трубку для автомобиля любой модели.

Для упрощения идентификации производителя и производственной партии каждая тормозная трубка, изготовленная в нашей фирме, маркируется специальной надписью, которая одновременно защищает наши изделия от подделок.

Чтобы вам было легче найти и подобрать детали из нашего ассортимента, мы подготовили этот каталог изделий WP. Это понятное и практичное издание появилось благодаря многолетнему сотрудничеству с нашими Клиентами с учетом их потребностей.

Желаю безопасной эксплуатации автомобилей с изделиями WP!

Witold Pniewski,

Założyciel i Dyrektor Przedsiębiorstwa „WP”
Founder & Chairman of „WP” Company
Основатель и директор предприятия «WP»



1996

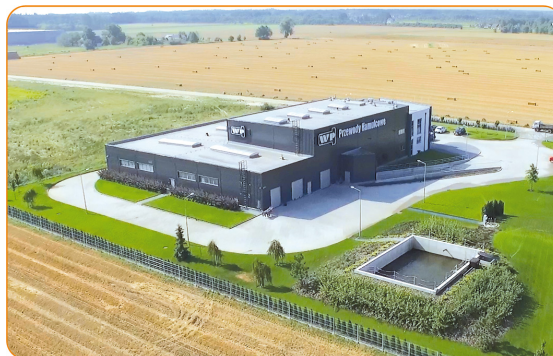

2016

Certyfikaty

Certificates / Сертификаты

CERTYFIKAT

DEKRA

WP

ISO 9001:2008

DEKRA Certification GmbH niniejszym potwierdza, że przedsiębiorstwo
Przedsiębiorstwo "WP" Bożena Pniewska

zakres certyfikacji:
Produkcja przewodów hamulcowych oraz elementów układu hamulcowego

certyfikowana siedziba:
PL-05-830 Nadarzyn, Kojetały ul. Miedziana 8

wdrożyło system zarządzania jakością zgodnie z ww. normą i skutecznie go realizuje. Wynik audytu udokumentowano w raporcie numer Z-A366814-A11-P-16949.
Certyfikat ważny od: 2015-09-16 do 2018-09-15
Nr rejestracyjny certyfikatu: 80915533

Ulrich **DEKRA**

Lothar Wölfel
DEKRA Certification GmbH Stuttgart, 2015-09-16

DEKRA Certification GmbH * Handwerkerstraße 15 * D-70565 Stuttgart * www.dekra-certification.de

strona 1 z 1

CERTYFIKAT

DEKRA

ISO/TS 16949:2009

DEKRA Certification GmbH potwierdza niniejszym, że przedsiębiorstwo
Przedsiębiorstwo "WP" Bożena Pniewska

zakres certyfikacji:
Produkcja przewodów hamulcowych oraz elementów układu hamulcowego

Bez 7.3 Opracowywanie nowych produktów.

certyfikowana siedziba:
PL-05-830 Nadarzyn, Kojetały ul. Miedziana 8

wdrożyło system zarządzania jakością zgodnie z ww. normą i skutecznie go realizuje. Wynik audytu udokumentowano w raporcie numer: Z-A366814-A11-P-16949.
Certyfikat ważny od 2015-09-16 do 2018-09-15
Nr rejestracyjny certyfikatu: 160915097 Numer IATF: 0219500

Ulrich **DEKRA**

Lothar Wölfel
DEKRA Certification GmbH Stuttgart, 2015-09-16

DEKRA Certification GmbH * Handwerkerstraße 15 * D-70565 Stuttgart * www.dekra-certification.de

strona 1 z 1

CERTYFIKAT
nr: TM 61000115.001

WP

Właściciel licencji
Przedsiębiorstwo "WP"
Bożena Pniewska
ul. Orlowska 9
05-800 Pruszków, PL

Miejsce produkcji
Przedsiębiorstwo "WP"
Bożena Pniewska
ul. Orlowska 9
05-800 Pruszków, PL

Numer projektu
26100123

Nasze oznaczenie
210/PS13/00045

Termin ważności
2018.05.12

Podstawa badań
PN-ISO 4038:1997 DIN 74234:1992

Opis certyfikowanego wyrobu / typ lub oznaczenie (identyfikacja urządzenia)
Przewody hamulcowe sztywne:
- Rura stalowa powlekana PVF Ø 4,76mm, grubość ścianki 0,71mm
- Rura miedziano-nikielowa CuNi Ø 4,75mm, grubość ścianki 0,71mm

Wyroby spełniają wymagania norm PN-ISO 4038:1997 oraz DIN 74234:1992

TÜV Rheinland Polska Sp. z o.o.
ul. 17 Syczyna 56
02-146 Warszawa, Polska
Tel.: (+48(22) 846 79 99
Tel.: (+48(22) 868 37 42
e-mail: post@pl.tuv.com

Jednostka Certyfikująca
Tomasz Opaszowski
Tomasz Opaszowski

Warszawa, 13.05.2013

Niniejszy certyfikat podlega Rejestracji Certyfikacji oraz Optymum Zakreślenia Techniki TÜV TRP i odnosi się wyłącznie do wyrobów zgodnych z warunkami stanowiącymi podstawę przeprowadzonej oceny zgodności. Niniejszy certyfikat samodzielnie nie upoważnia właściciela do umieszczenia oznaczenia CE.

TÜV Rheinland POLSKA
M + T
OWALCZAK
SPOŁACZYSTWA
Produktion monitored
Product tested

TÜVRheinland®
Precisely Right.
www.tuv.pl

Formularz nr: F04-P-008-01-V09

ТАМОЖЕННЫЙ СОЮЗ

СЕРТИФИКАТ СООТВЕТСТВИЯ

№ ТС RU C-PL.MT22.B.03710
Серия RU № 0403100

ОРГАН ПО СЕРТИФИКАЦИИ СПЕЦИАЛЬНЫХ И СПЕЦИАЛИЗИРОВАННЫХ АВТОТРАНСПОРТНЫХ СРЕДСТВ И УСЛУГ НА АВТОМОБИЛЬНОМ ТРАНСПОРТЕ НЕКОММЕРЧЕСКОЙ ОРГАНИЗАЦИИ «ФОНД РАЗВИТИЯ СЕРТИФИКАЦИИ СПЕЦИАЛИЗИРОВАННЫХ АВТОТРАНСПОРТНЫХ СРЕДСТВ МЕХАНИЗАЦИИ И ТЕХНОЛОГИЙ ВЫСОКИННОЙ РАБОТЫ В СТРОИТЕЛЬСТВЕ»
Юридический адрес: улица Павловский, дом 7, строение 4, город Москва, Российская Федерация, 105062
Фактический адрес: улица Павловский, дом 7, строение 4, город Москва, Российская Федерация, 105062
Телефон/факс: (495) 7064755, e-mail: info@iamt-bond.ru. Аттестат аккредитации № РОСС RU.0001.10M122 зарегистрирован в Государственном реестре от 15 июля 2014 года, выдан Федеральной службой по аккредитации

ЗАЯВИТЕЛЬ Общество с ограниченной ответственностью «КОНСАЛТИНГОВЫЙ ЦЕНТР «ЭКСПЕРТ»
Юридический адрес: Российская Федерация, 119017, город Москва, улица Большая Ордынка, дом 54, строение 2
Фактический адрес: Российская Федерация, 119017, город Москва, улица Большая Ордынка, дом 54, строение 2
Телефон/Факс +7 916 665-72-17 ОГРН: 1157746924290 e-mail: info@706427830@gmail.com

ИЗГОТОВИТЕЛЬ Przedsiębiorstwo "W" Bozena Pnielwka
Юридический адрес: Kajetany, Miedziana 8, 05-830 Nadarzyn, Польша
Фактический адрес: Kajetany, Miedziana 8, 05-830 Nadarzyn, Польша

Компоненты, поставляемые в качестве запасных (запаски) частей для послепродажного обслуживания транспортных средств Alfa Romeo, Audi, BMW, Citroen, Daewoo, Fiat, Ford, Honda, Hyundai, Isuzu, KIA, LADA, Mazda, Mercedes, Mitsubishi, Nissan, Opel, Peugeot, Renault, Saab, Seat, Skoda, Suzuki, Toyota, Volvo, Volkswagen - Турбин газораспределительных систем турбомоторов привода (турбокомпрессоры - см. Приложение, бланк 0295437); Регулируемые устройства тормозных механизмов (типа WPS-1.0**, WPS-1.1**, WPS-1.2**, WPS-1.3**, WPS-1.4**, WPS-1.5**, WPS-1.6**, WPS-1.7**, WPS-1.8**, WPS-1.9**, WPS-1.10**, WPS-1.11**, WPS-1.12**, WPS-1.13**, WPS-1.14**, WPS-1.15**, WPS-1.16**, WPS-1.17**, WPS-1.18**, WPS-1.19**, WPS-1.20**, WPS-1.21**, WPS-1.22**, WPS-1.23**, WPS-1.24**, WPS-1.25**, WPS-1.26**, WPS-1.27**, WPS-1.28**, WPS-1.29**, WPS-1.30**, WPS-1.31**, WPS-1.32**, WPS-1.33**, WPS-1.34**, WPS-1.35**, WPS-1.36**, WPS-1.37**, WPS-1.38**, WPS-1.39**, WPS-1.40**, WPS-1.41**, WPS-1.42**, WPS-1.43**, WPS-1.44**, WPS-1.45**, WPS-1.46**, WPS-1.47**, WPS-1.48**, WPS-1.49**, WPS-1.50**, WPS-1.51**, WPS-1.52**, WPS-1.53**, WPS-1.54**, WPS-1.55**, WPS-1.56**, WPS-1.57**, WPS-1.58**, WPS-1.59**, WPS-1.60**, WPS-1.61**, WPS-1.62**, WPS-1.63**, WPS-1.64**, WPS-1.65**, WPS-1.66**, WPS-1.67**, WPS-1.68**, WPS-1.69**, WPS-1.70**, WPS-1.71**, WPS-1.72**, WPS-1.73**, WPS-1.74**, WPS-1.75**, WPS-1.76**, WPS-1.77**, WPS-1.78**, WPS-1.79**, WPS-1.80**, WPS-1.81**, WPS-1.82**, WPS-1.83**, WPS-1.84**, WPS-1.85**, WPS-1.86**, WPS-1.87**, WPS-1.88**, WPS-1.89**, WPS-1.90**, WPS-1.91**, WPS-1.92**, WPS-1.93**, WPS-1.94**, WPS-1.95**, WPS-1.96**, WPS-1.97**, WPS-1.98**, WPS-1.99**, WPS-2.00**, WPS-2.01**, WPS-2.02**, WPS-2.03**, WPS-2.04**, WPS-2.05**, WPS-2.06**, WPS-2.07**, WPS-2.08**, WPS-2.09**, WPS-2.10**, WPS-2.11**, WPS-2.12**, WPS-2.13**, WPS-2.14**, WPS-2.15**, WPS-2.16**, WPS-2.17**, WPS-2.18**, WPS-2.19**, WPS-2.20**, WPS-2.21**, WPS-2.22**, WPS-2.23**, WPS-2.24**, WPS-2.25**, WPS-2.26**, WPS-2.27**, WPS-2.28**, WPS-2.29**, WPS-2.30**, WPS-2.31**, WPS-2.32**, WPS-2.33**, WPS-2.34**, WPS-2.35**, WPS-2.36**, WPS-2.37**, WPS-2.38**, WPS-2.39**, WPS-2.40**, WPS-2.41**, WPS-2.42**, WPS-2.43**, WPS-2.44**, WPS-2.45**, WPS-2.46**, WPS-2.47**, WPS-2.48**, WPS-2.49**, WPS-2.50**, WPS-2.51**, WPS-2.52**, WPS-2.53**, WPS-2.54**, WPS-2.55**, WPS-2.56**, WPS-2.57**, WPS-2.58**, WPS-2.59**, WPS-2.60**, WPS-2.61**, WPS-2.62**, WPS-2.63**, WPS-2.64**, WPS-2.65**, WPS-2.66**, WPS-2.67**, WPS-2.68**, WPS-2.69**, WPS-2.70**, WPS-2.71**, WPS-2.72**, WPS-2.73**, WPS-2.74**, WPS-2.75**, WPS-2.76**, WPS-2.77**, WPS-2.78**, WPS-2.79**, WPS-2.80**, WPS-2.81**, WPS-2.82**, WPS-2.83**, WPS-2.84**, WPS-2.85**, WPS-2.86**, WPS-2.87**, WPS-2.88**, WPS-2.89**, WPS-2.90**, WPS-2.91**, WPS-2.92**, WPS-2.93**, WPS-2.94**, WPS-2.95**, WPS-2.96**, WPS-2.97**, WPS-2.98**, WPS-2.99**, WPS-3.00**, WPS-3.01**, WPS-3.02**, WPS-3.03**, WPS-3.04**, WPS-3.05**, WPS-3.06**, WPS-3.07**, WPS-3.08**, WPS-3.09**, WPS-3.10**, WPS-3.11**, WPS-3.12**, WPS-3.13**, WPS-3.14**, WPS-3.15**, WPS-3.16**, WPS-3.17**, WPS-3.18**, WPS-3.19**, WPS-3.20**, WPS-3.21**, WPS-3.22**, WPS-3.23**, WPS-3.24**, WPS-3.25**, WPS-3.26**, WPS-3.27**, WPS-3.28**, WPS-3.29**, WPS-3.30**, WPS-3.31**, WPS-3.32**, WPS-3.33**, WPS-3.34**, WPS-3.35**, WPS-3.36**, WPS-3.37**, WPS-3.38**, WPS-3.39**, WPS-3.40**, WPS-3.41**, WPS-3.42**, WPS-3.43**, WPS-3.44**, WPS-3.45**, WPS-3.46**, WPS-3.47**, WPS-3.48**, WPS-3.49**, WPS-3.50**, WPS-3.51**, WPS-3.52**, WPS-3.53**, WPS-3.54**, WPS-3.55**, WPS-3.56**, WPS-3.57**, WPS-3.58**, WPS-3.59**, WPS-3.60**, WPS-3.61**, WPS-3.62**, WPS-3.63**, WPS-3.64**, WPS-3.65**, WPS-3.66**, WPS-3.67**, WPS-3.68**, WPS-3.69**, WPS-3.70**, WPS-3.71**, WPS-3.72**, WPS-3.73**, WPS-3.74**, WPS-3.75**, WPS-3.76**, WPS-3.77**, WPS-3.78**, WPS-3.79**, WPS-3.80**, WPS-3.81**, WPS-3.82**, WPS-3.83**, WPS-3.84**, WPS-3.85**, WPS-3.86**, WPS-3.87**, WPS-3.88**, WPS-3.89**, WPS-3.90**, WPS-3.91**, WPS-3.92**, WPS-3.93**, WPS-3.94**, WPS-3.95**, WPS-3.96**, WPS-3.97**, WPS-3.98**, WPS-3.99**, WPS-4.00**, WPS-4.01**, WPS-4.02**, WPS-4.03**, WPS-4.04**, WPS-4.05**, WPS-4.06**, WPS-4.07**, WPS-4.08**, WPS-4.09**, WPS-4.10**, WPS-4.11**, WPS-4.12**, WPS-4.13**, WPS-4.14**, WPS-4.15**, WPS-4.16**, WPS-4.17**, WPS-4.18**, WPS-4.19**, WPS-4.20**, WPS-4.21**, WPS-4.22**, WPS-4.23**, WPS-4.24**, WPS-4.25**, WPS-4.26**, WPS-4.27**, WPS-4.28**, WPS-4.29**, WPS-4.30**, WPS-4.31**, WPS-4.32**, WPS-4.33**, WPS-4.34**, WPS-4.35**, WPS-4.36**, WPS-4.37**, WPS-4.38**, WPS-4.39**, WPS-4.40**, WPS-4.41**, WPS-4.42**, WPS-4.43**, WPS-4.44**, WPS-4.45**, WPS-4.46**, WPS-4.47**, WPS-4.48**, WPS-4.49**, WPS-4.50**, WPS-4.51**, WPS-4.52**, WPS-4.53**, WPS-4.54**, WPS-4.55**, WPS-4.56**, WPS-4.57**, WPS-4.58**, WPS-4.59**, WPS-4.60**, WPS-4.61**, WPS-4.62**, WPS-4.63**, WPS-4.64**, WPS-4.65**, WPS-4.66**, WPS-4.67**, WPS-4.68**, WPS-4.69**, WPS-4.70**, WPS-4.71**, WPS-4.72**, WPS-4.73**, WPS-4.74**, WPS-4.75**, WPS-4.76**, WPS-4.77**, WPS-4.78**, WPS-4.79**, WPS-4.80**, WPS-4.81**, WPS-4.82**, WPS-4.83**, WPS-4.84**, WPS-4.85**, WPS-4.86**, WPS-4.87**, WPS-4.88**, WPS-4.89**, WPS-4.90**, WPS-4.91**, WPS-4.92**, WPS-4.93**, WPS-4.94**, WPS-4.95**, WPS-4.96**, WPS-4.97**, WPS-4.98**, WPS-4.99**, WPS-5.00**, WPS-5.01**, WPS-5.02**, WPS-5.03**, WPS-5.04**, WPS-5.05**, WPS-5.06**, WPS-5.07**, WPS-5.08**, WPS-5.09**, WPS-5.10**, WPS-5.11**, WPS-5.12**, WPS-5.13**, WPS-5.14**, WPS-5.15**, WPS-5.16**, WPS-5.17**, WPS-5.18**, WPS-5.19**, WPS-5.20**, WPS-5.21**, WPS-5.22**, WPS-5.23**, WPS-5.24**, WPS-5.25**, WPS-5.26**, WPS-5.27**, WPS-5.28**, WPS-5.29**, WPS-5.30**, WPS-5.31**, WPS-5.32**, WPS-5.33**, WPS-5.34**, WPS-5.35**, WPS-5.36**, WPS-5.37**, WPS-5.38**, WPS-5.39**, WPS-5.40**, WPS-5.41**, WPS-5.42**, WPS-5.43**, WPS-5.44**, WPS-5.45**, WPS-5.46**, WPS-5.47**, WPS-5.48**, WPS-5.49**, WPS-5.50**, WPS-5.51**, WPS-5.52**, WPS-5.53**, WPS-5.54**, WPS-5.55**, WPS-5.56**, WPS-5.57**, WPS-5.58**, WPS-5.59**, WPS-5.60**, WPS-5.61**, WPS-5.62**, WPS-5.63**, WPS-5.64**, WPS-5.65**, WPS-5.66**, WPS-5.67**, WPS-5.68**, WPS-5.69**, WPS-5.70**, WPS-5.71**, WPS-5.72**, WPS-5.73**, WPS-5.74**, WPS-5.75**, WPS-5.76**, WPS-5.77**, WPS-5.78**, WPS-5.79**, WPS-5.80**, WPS-5.81**, WPS-5.82**, WPS-5.83**, WPS-5.84**, WPS-5.85**, WPS-5.86**, WPS-5.87**, WPS-5.88**, WPS-5.89**, WPS-5.90**, WPS-5.91**, WPS-5.92**, WPS-5.93**, WPS-5.94**, WPS-5.95**, WPS-5.96**, WPS-5.97**, WPS-5.98**, WPS-5.99**, WPS-6.00**, WPS-6.01**, WPS-6.02**, WPS-6.03**, WPS-6.04**, WPS-6.05**, WPS-6.06**, WPS-6.07**, WPS-6.08**, WPS-6.09**, WPS-6.10**, WPS-6.11**, WPS-6.12**, WPS-6.13**, WPS-6.14**, WPS-6.15**, WPS-6.16**, WPS-6.17**, WPS-6.18**, WPS-6.19**, WPS-6.20**, WPS-6.21**, WPS-6.22**, WPS-6.23**, WPS-6.24**, WPS-6.25**, WPS-6.26**, WPS-6.27**, WPS-6.28**, WPS-6.29**, WPS-6.30**, WPS-6.31**, WPS-6.32**, WPS-6.33**, WPS-6.34**, WPS-6.35**, WPS-6.36**, WPS-6.37**, WPS-6.38**, WPS-6.39**, WPS-6.40**, WPS-6.41**, WPS-6.42**, WPS-6.43**, WPS-6.44**, WPS-6.45**, WPS-6.46**, WPS-6.47**, WPS-6.48**, WPS-6.49**, WPS-6.50**, WPS-6.51**, WPS-6.52**, WPS-6.53**, WPS-6.54**, WPS-6.55**, WPS-6.56**, WPS-6.57**, WPS-6.58**, WPS-6.59**, WPS-6.60**, WPS-6.61**, WPS-6.62**, WPS-6.63**, WPS-6.64**, WPS-6.65**, WPS-6.66**, WPS-6.67**, WPS-6.68**, WPS-6.69**, WPS-6.70**, WPS-6.71**, WPS-6.72**, WPS-6.73**, WPS-6.74**, WPS-6.75**, WPS-6.76**, WPS-6.77**, WPS-6.78**, WPS-6.79**, WPS-6.80**, WPS-6.81**, WPS-6.82**, WPS-6.83**, WPS-6.84**, WPS-6.85**, WPS-6.86**, WPS-6.87**, WPS-6.88**, WPS-6.89**, WPS-6.90**, WPS-6.91**, WPS-6.92**, WPS-6.93**, WPS-6.94**, WPS-6.95**, WPS-6.96**, WPS-6.97**, WPS-6.98**, WPS-6.99**, WPS-7.00**, WPS-7.01**, WPS-7.02**, WPS-7.03**, WPS-7.04**, WPS-7.05**, WPS-7.06**, WPS-7.07**, WPS-7.08**, WPS-7.09**, WPS-7.10**, WPS-7.11**, WPS-7.12**, WPS-7.13**, WPS-7.14**, WPS-7.15**, WPS-7.16**, WPS-7.17**, WPS-7.18**, WPS-7.19**, WPS-7.20**, WPS-7.21**, WPS-7.22**, WPS-7.23**, WPS-7.24**, WPS-7.25**, WPS-7.26**, WPS-7.27**, WPS-7.28**, WPS-7.29**, WPS-7.30**, WPS-7.31**, WPS-7.32**, WPS-7.33**, WPS-7.34**, WPS-7.35**, WPS-7.36**, WPS-7.37**, WPS-7.38**, WPS-7.39**, WPS-7.40**, WPS-7.41**, WPS-7.42**, WPS-7.43**, WPS-7.44**, WPS-7.45**, WPS-7.46**, WPS-7.47**, WPS-7.48**, WPS-7.49**, WPS-7.50**, WPS-7.51**, WPS-7.52**, WPS-7.53**, WPS-7.54**, WPS-7.55**, WPS-7.56**, WPS-7.57**, WPS-7.58**, WPS-7.59**, WPS-7.60**, WPS-7.61**, WPS-7.62**, WPS-7.63**, WPS-7.64**, WPS-7.65**, WPS-7.66**, WPS-7.67**, WPS-7.68**, WPS-7.69**, WPS-7.70**, WPS-7.71**, WPS-7.72**, WPS-7.73**, WPS-7.74**, WPS-7.75**, WPS-7.76**, WPS-7.77**, WPS-7.78**, WPS-7.79**, WPS-7.80**, WPS-7.81**, WPS-7.82**, WPS-7.83**, WPS-7.84**, WPS-7.85**, WPS-7.86**, WPS-7.87**, WPS-7.88**, WPS-7.89**, WPS-7.90**, WPS-7.91**, WPS-7.92**, WPS-7.93**, WPS-7.94**, WPS-7.95**, WPS-7.96**, WPS-7.97**, WPS-7.98**, WPS-7.99**, WPS-8.00**, WPS-8.01**, WPS-8.02**, WPS-8.03**, WPS-8.04**, WPS-8.05**, WPS-8.06**, WPS-8.07**, WPS-8.08**, WPS-8.09**, WPS-8.10**, WPS-8.11**, WPS-8.12**, WPS-8.13**, WPS-8.14**, WPS-8.15**, WPS-8.16**, WPS-8.17**, WPS-8.18**, WPS-8.19**, WPS-8.20**, WPS-8.21**, WPS-8.22**, WPS-8.23**, WPS-8.24**, WPS-8.25**, WPS-8.26**, WPS-8.27**, WPS-8.28**, WPS-8.29**, WPS-8.30**, WPS-8.31**, WPS-8.32**, WPS-8.33**, WPS-8.34**, WPS-8.35**, WPS-8.36**, WPS-8.37**, WPS-8.38**, WPS-8.39**, WPS-8.40**, WPS-8.41**, WPS-8.42**, WPS-8.43**, WPS-8.44**, WPS-8.45**, WPS-8.46**, WPS-8.47**, WPS-8.48**, WPS-8.49**, WPS-8.50**, WPS-8.51**, WPS-8.52**, WPS-8.53**, WPS-8.54**, WPS-8.55**, WPS-8.56**, WPS-8.57**, WPS-8.58**, WPS-8.59**, WPS-8.60**, WPS-8.61**, WPS-8.62**, WPS-8.63**, WPS-8.64**, WPS-8.65**, WPS-8.66**, WPS-8.67**, WPS-8.68**, WPS-8.69**, WPS-8.70**, WPS-8.71**, WPS-8.72**, WPS-8.73**, WPS-8.74**, WPS-8.75**, WPS-8.76**, WPS-8.77**, WPS-8.78**, WPS-8.79**, WPS-8.80**, WPS-8.81**, WPS-8.82**, WPS-8.83**, WPS-8.84**, WPS-8.85**, WPS-8.86**, WPS-8.87**, WPS-8.88**, WPS-8.89**, WPS-8.90**, WPS-8.91**, WPS-8.92**, WPS-8.93**, WPS-8.94**, WPS-8.95**, WPS-8.96**, WPS-8.97**, WPS-8.98**, WPS-8.99**, WPS-9.00**, WPS-9.01**, WPS-9.02**, WPS-9.03**, WPS-9.04**, WPS-9.05**, WPS-9.06**, WPS-9.07**, WPS-9.08**, WPS-9.09**, WPS-9.10**, WPS-9.11**, WPS-9.12**, WPS-9.13**, WPS-9.14**, WPS-9.15**, WPS-9.16**, WPS-9.17**, WPS-9.18**, WPS-9.19**, WPS-9.20**, WPS-9.21**, WPS-9.22**, WPS-9.23**, WPS-9.24**, WPS-9.25**, WPS-9.26**, WPS-9.27**, WPS-9.28**, WPS-9.29**, WPS-9.30**, WPS-9.31**, WPS-9.32**, WPS-9.33**, WPS-9.34**, WPS-9.35**, WPS-9.36**, WPS-9.37**, WPS-9.38**, WPS-9.39**, WPS-9.40**, WPS-9.41**, WPS-9.42**, WPS-9.43**, WPS-9.44**, WPS-9.45**, WPS-9.46**, WPS-9.47**, WPS-9.48**, WPS-9.49**, WPS-9.50**, WPS-9.51**, WPS-9.52**, WPS-9.53**, WPS-9.54**, WPS-9.55**, WPS-9.56**, WPS-9.57**, WPS-9.58**, WPS-9.59**, WPS-9.60**, WPS-9.61**, WPS-9.62**, WPS-9.63**, WPS-9.64**, WPS-9.65**, WPS-9.66**, WPS-9.67**, WPS-9.68**, WPS-9.69**, WPS-9.70**, WPS-9.71**, WPS-9.72**, WPS-9.73**, WPS-9.74**, WPS-9.75**, WPS-9.76**, WPS-9.77**, WPS-9.78**, WPS-9.79**, WPS-9.80**, WPS-9.81**, WPS-9.82**, WPS-9.83**, WPS-9.84**, WPS-9.85**, WPS-9.86**, WPS-9.87**, WPS-9.88**, WPS-9.89**, WPS-9.90**, WPS-9.91**, WPS-9.92**, WPS-9.93**, WPS-9.94**, WPS-9.95**, WPS-9.96**, WPS-9.97**, WPS-9.98**, WPS-9.99

СРОК ДЕЙСТВИЯ С 04.08.2016 ПО 03.08.2020 **ВКЛЮЧИТЕЛЬНО**

Руководитель (уполномоченное лицо) органа по сертификации: М.А. Штучкин
Эксперт (эксперт-аудитор) (эксперты (эксперты-аудиторы)): С.В. Карасев

ТАМОЖЕННЫЙ СОЮЗ

ПРИЛОЖЕНИЕ

К СЕРТИФИКАТУ СООТВЕТСТВИЯ № ТС RU C-PL.MT22.B.03710
Серия RU № 0295437

Условные обозначения, используемые для идентификации¹⁾

Структура артикула - А* В* С* D* E* F* J* G* H*

Позиция	Содержание символа
A	Обозначение типа транспортного средства, состоящее из четырех значений: - конструктивных символов: 01 - однокопировая тормозная система; 02 - двухкопировая тормозная система; 33 - 4х цилиндровый двигатель; 34 - 6ти цилиндровый двигатель; 35 - 8ти цилиндровый двигатель; 66 - с барбанированными тормозными дисками колес; 67 - с дисковыми тормозными дисками колес; 68 - с барабанными тормозными дисками колес; 69 - с дисковыми тормозными дисками колес; 71 - без сцепителя тормоза; 72 - с сцепителем тормоза; 73 - без тормозного регулятора; 74 - с тормозным регулятором; 75 - необходима установка в клапане тормозной линии; 80 - с миллиметровый резьбой; 81 - с дюймовой резьбой - марка автотранспортного средства: - модель автотранспортного средства - номер кузова (содержит обозначения Инженерного автотранспортного средства)
B	Номер набора: ZWP-S***, ZWP-G***, ZWP-T***, ZWP-R***, ZWP-S***, ZWP-R***
C	Первичность выпуска автомобиля: **>***, где первые два символа - месяц выпуска, третий и четвертый символ - год выпуска
D	Обозначение типа штифтера прокачки тормозов: *****, где * - любая буква от A до Z
E	WP код: WP-*****, любая цифра от 0 до 9 или буква от A до Z
F	Мест установки: ZPL наружный фронт левый; ZPR наружный фронт правый; FL фронт левый; FR фронт правый; TL зад левый; TR зад правый; ZTL наружный зад левый; ZTR наружный зад правый; SC центральный; CL центральный левый; SF центральный правый; ST центральный левый; STP центральный зад правый; SFL центральный фронт левый; SFR центральный фронт правый; STL центральный зад левый; STP центральный зад правый; PKL насос регулятор левый; PRP насос регулятор правый; **>*** - длинный тормозной трубки; POM-LACZ P насос соединитель передний; POM-LACZ T насос соединитель задний; KOST-TROJ кубик трюинкс; KOST-RED кубик регулятор; POM-LACZ насос соединитель; KOR корректор; POM-SYG K насос сигнализатор тормозной; POM-SYG D насос сигнализатор аварийной; SYK-KOS сигнализатор колес; PP ROZ I OBYV фронт правый распределитель 1 контура; PP ROZ II OBYV фронт правый распределитель 2 контура; PL ROZ I OBYV фронт левый распределитель 1 контура; PL ROZ II OBYV фронт левый распределитель 2 контура; KOR-TROJ корректор трюинкс; POM-ROZ I OBYV насос распределитель 1 контура; POM-ROZ II OBYV насос распределитель 2 контура; TM зад мост; POM-ABS насос-ABS; KOR-ABS корректор-ABS
J	Палочка WP: P**>***, где * - любая цифра от 0 до 9

Обозначение типа транспортного средства, выданные Органом по сертификации механических транспортных средств и прицепов, их составных частей и предметов оборудования «САТР-Фонд» Межгосударственного Фонда «Сертификация автотранспорта», аттестат аккредитации № РОСС RU.0001.11M122:
E-ET.MT02.B.00046 (Alfa Romeo); E-DE.MT02.B.00023.P1 (Daewoo); E-DE.MT02.B.00110 (Audi); E-DE.MT02.B.00065 (E-DE.MT02.B.00244 (Ford); E-ET.MT02.B.00195 (LADA); E-ET.MT02.B.00294 (E-ET.MT02.B.00319 (Fiat); E-DE.MT02.B.00216 (Ford); E-ET.MT02.B.00089 (Mercedes); E-ET.MT02.B.00143 (Mitsubishi); E-ET.MT02.B.00239 (E-ET.MT02.B.00306 (Nissan); E-DE.MT02.B.00050.P1 (E-DE.MT02.B.00238 (Opel); E-ET.MT02.B.00171 (Peugeot); E-ET.MT02.B.00107.P1 (Renault); E-ES.MT02.B.00068.P1 (Seat); E-ET.MT02.B.00083.P1 (Skoda); E-DE.MT02.B.00208 (Toyota); E-SE.MT02.B.00111.P1 (Volvo); E-DE.MT02.B.00069.P1 (E-DE.MT02.B.00024 (E-DE.MT02.B.00090 (VW).

Обозначение типа транспортного средства, выданные Органом по сертификации продукции машиностроения ФГУП «Всероссийский научно-исследовательский институт стандартизации и сертификации в машиностроении», аттестат аккредитации № РОСС RU.0001.11A104:
E-ET.MT02.B.00046 (Alfa Romeo); E-DE.MT02.B.00023.P1 (Daewoo); E-DE.MT02.B.00110 (Audi); E-DE.MT02.B.00065 (E-DE.MT02.B.00244 (Ford); E-ET.MT02.B.00195 (LADA); E-ET.MT02.B.00294 (E-ET.MT02.B.00319 (Fiat); E-DE.MT02.B.00216 (Ford); E-ET.MT02.B.00089 (Mercedes); E-ET.MT02.B.00143 (Mitsubishi); E-ET.MT02.B.00239 (E-ET.MT02.B.00306 (Nissan); E-DE.MT02.B.00050.P1 (E-DE.MT02.B.00238 (Opel); E-ET.MT02.B.00171 (Peugeot); E-ET.MT02.B.00107.P1 (Renault); E-ES.MT02.B.00068.P1 (Seat); E-ET.MT02.B.00083.P1 (Skoda); E-DE.MT02.B.00208 (Toyota); E-SE.MT02.B.00111.P1 (Volvo); E-DE.MT02.B.00069.P1 (E-DE.MT02.B.00024 (E-DE.MT02.B.00090 (VW).

Обозначение типа шасси, выданные Органом по сертификации механических транспортных средств и прицепов, их составных частей и предметов оборудования «САТР-Фонд» Межгосударственного Фонда «Сертификация автотранспорта», аттестат аккредитации № РОСС RU.0001.11M122:
E-ET.MT02.B.00077.P1 (E-ET.MT02.B.00109 (Isuzu)

WORLD INTELLECTUAL PROPERTY ORGANIZATION

MADRID AGREEMENT AND PROTOCOL

CERTIFICATE OF REGISTRATION

The International Bureau of the World Intellectual Property Organization (WIPO) certifies that the indications appearing in the present certificate conform to the recording made in the International Register of Marks maintained under the Madrid Agreement and Protocol.

Judith ZAHRA
Officer-in-charge
International Registrations Department
Operations Division

Geneva, July 31, 2008

968 796

Registration date: May 5, 2008
Date next payment due: May 5, 2018

PRZEDSIĘBIORSTWO "W"
Bozena Pnielwka
ul. Ołówekowa 9
PL-05-800 PRUSZKÓW
(Poland).

Classification of figurative elements:
14.3.27.5

List of goods and services - NCL(9):
12 Parts of vehicles and vehicles accessories.
Basic registration: Poland, 26.01.2004, 151476
Designations under the Madrid Agreement: Belarus, Russian Federation, Ukraine.
Designations under the Madrid Protocol: European Community.
Date of notification: 31.07.2008
Language of the international application: English

Identyfikacja przewodów hamulcowych

Brake lines identification / Идентификация тормозных трубок

Marka „WP” jest rozpoznawalna w przemyśle motoryzacyjnym zarówno w kraju, jak i na świecie, a co za tym idzie również niestety podrabiana. W trosce o swoich klientów i jakość naszych wyrobów znakujemy nasze przewody specjalnym nadrukiem zawierającym informacje potrzebne do identyfikacji naszego wyrobu.

„WP” brand is easily recognized in national as well as worldwide automotive industry, but at the same time falsified unluckily. To protect our customers as well as quality of our products, we mark our brake lines with special overprint including all necessary data required for identification.

Марка «WP» узнаваема в автомобильной отрасли как в стране, так и в мире, в связи с этим наши товары, к сожалению, подделывают. Заботясь о своих клиентах и качестве наших изделий, мы маркируем нашей трубки специальной надписью, содержащей сведения, необходимые для идентификации нашего изделия.



Grubość ścianki rurki miedzianej

Wall thickness of copper tube / Толщина стенки медной трубки

W celu zapewnienia odpowiedniej wytrzymałości w czasie pracy pod ciśnieniem w układzie hamulcowym wszystkie miedziane przewody hamulcowe Przedsiębiorstwa „WP” o średnicy zewnętrznej 4,75 mm posiadają zalecaną grubość ścianki 0,90 mm.

Więcej informacji na ten temat: 09mm.pwpnet.pl

In order to ensure appropriate strength while working under pressure in the brake system all copper brake lines of „WP” Company with an outer diameter of 4.75 mm have the recommended wall thickness of 0.90 mm.

More information: 09mm.pwpnet.pl

Для обеспечения соответствующей прочности во время работы под давлением в тормозной системе все медные тормозные трубки предприятия «WP» с внешним диаметром 4,75 мм имеют рекомендованную толщину стенки 0,90 мм. Более подробная информация на эту тему: 09mm.pwpnet.pl



Pakowanie przewodów hamulcowych

Brake lines packing / Упаковка тормозных трубок

Przewody „WP” pakowane są z dużą starannością, aby uniemożliwić ich uszkodzenie w transporcie i podczas magazynowania. Każdy zwój zabezpieczony jest folią termozgrzewalną oraz oznaczony odpowiednią etykietą. Gotowe przewody hamulcowe zakończone są natomiast ochronnymi kapturkami, zapobiegającymi przesuwaniu się złączek na przewodzie oraz uniemożliwiającym dostawaniu się zanieczyszczeń do środka przewodu. Pozostałe drobne elementy z naszej oferty pakowane są w funkcjonalne pudełka kartonowe.

„WP” brake lines are packed with greatest care to prevent from being damaged during transportation or while stored. Each brake tube coil is secured with heat-shrinkable foil and marked with suitable label. Ready-made brake lines are tipped with protective caps to avoid any fittings displacement along the lines and inside contamination. Other small braking system elements are packed in functional cardboard boxes.

Трубки «WP» тщательно упаковываются, чтобы не повредить их во время транспортировки и хранения. Каждый рулон защищен термоусадочной пленкой и обозначен соответствующей этикеткой. Готовые тормозные трубки в свою очередь закрыты защитными колпачками, препятствующими смещению наконечников на трубке и попаданию загрязнений внутрь трубки. Остальные мелкие элементы из нашего ассортимента упаковываются в функциональные картонные коробки.



Rodzaje spęczeń

Flare types / Виды вальцовок

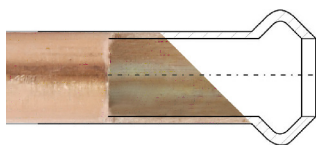

SPĘCZENIE POJEDYNCZE (SF)

-spęczenie używane w przewodach hamulcowych większości samochodów europejskich.

SINGLE FLARED LINE

-brake line flare used in most european cars.

ОДНОСТОРОННЯ РАЗВАЛЬЦОВКА (SF)

- развальцовка, используемая в тормозных трубках большинства европейских автомобилей.

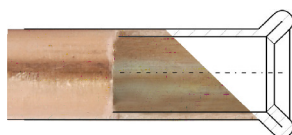

SPĘCZENIE NIESTANDARDOWE (DF)

- spęczenie używane w przewodach hamulcowych większości samochodów azjatyckich.

DOUBLE FLARED LINE

- brake line flare used for most asian cars.

ДВОЙНАЯ РАЗВАЛЬЦОВКА (DF)

- развальцовка, используемая в тормозных трубках большинства азиатских автомобилей.

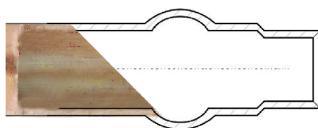

SPĘCZENIE DO CITROENA

- typ spęczenia używany w przewodach hamulcowych samochodów marki Citroen (BX, CX, 2CV, Xantia).

CITROEN FLARE TYPE

- brake line flare type used for Citroen cars (BX, CX, 2CV, Xantia).

РАЗВАЛЬЦОВКА ДЛЯ «СИТРОЕНА»

- тип развальцовки, используемой в тормозных трубках автомобилей марки Citroen (BX, CX, 2CV, Xantia).

Lokalizacja przewodu hamulcowego

Brake tube location / Местоположение тормозного трубки

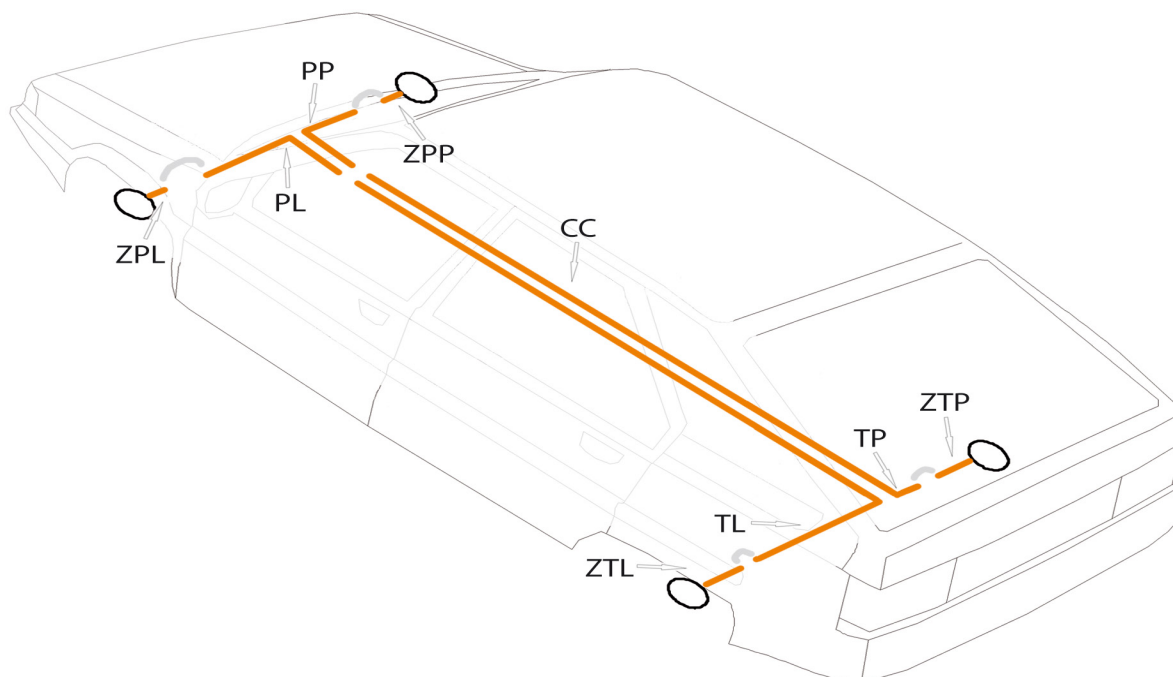

Symbol
Symbol
Символы

Opis

Description

Описание

Symbol	Opis	Description	Описание
ZPL	ZEWNĘTRZNY PRZÓD LEWY	OUTSIDE FRONT LEFT	НАРУЖНЫЙ ФРОНТ ЛЕВЫЙ
ZPP	ZEWNĘTRZNY PRZÓD PRAWY	OUTSIDE FRONT RIGHT	НАРУЖНЫЙ ФРОНТ ПРАВЫЙ
PL	PRZÓD LEWY	FRONT LEFT	ФРОНТ ЛЕВЫЙ
PP	PRZÓD PRAWY	FRONT RIGHT	ФРОНТ ПРАВЫЙ
TL	TYŁ LEWY	REAR LEFT	ЗАД ЛЕВЫЙ
TP	TYŁ PRAWY	REAR RIGHT	ЗАД ПРАВЫЙ
ZTL	ZEWNĘTRZNY TYŁ LEWY	OUTSIDE REAR LEFT	НАРУЖНЫЙ ЗАД ЛЕВЫЙ
ZTP	ZEWNĘTRZNY TYŁ PRAWY	OUTSIDE REAR RIGHT	НАРУЖНЫЙ ЗАД ПРАВЫЙ
CC	CENTRALNY	CENTRAL	ЦЕНТРАЛЬНЫЙ
CL	CENTRALNY LEWY	CENTRAL LEFT	ЦЕНТРАЛЬНЫЙ ЛЕВЫЙ
CP	CENTRALNY PRAWY	CENTRAL RIGHT	ЦЕНТРАЛЬНЫЙ ПРАВЫЙ
SP	ŚRODKOWY PRZÓD	MIDDLE FRONT	ЦЕНТРАЛЬНЫЙ ФРОНТ
ST	ŚRODKOWY TYŁ	MIDDLE REAR	ЦЕНТРАЛЬНЫЙ ЗАД
SPL	ŚRODKOWY PRZÓD LEWY	MIDDLE FRONT LEFT	ЦЕНТРАЛЬНЫЙ ФРОНТ ЛЕВЫЙ
SPP	ŚRODKOWY PRZÓD PRAWY	MIDDLE FRONT RIGHT	ЦЕНТРАЛЬНЫЙ ФРОНТ ПРАВЫЙ
STL	ŚRODKOWY TYŁ LEWY	MIDDLE REAR LEFT	ЦЕНТРАЛЬНЫЙ ЗАД ЛЕВЫЙ
STP	ŚRODKOWY TYŁ PRAWY	MIDDLE REAR RIGHT	ЦЕНТРАЛЬНЫЙ ЗАД ПРАВЫЙ
PRL	POMPA REDUKTOR LEWY	PUMP REDUCTOR LEFT	НАСОС РЕДУКТОР ЛЕВЫЙ
PRP	POMPA REDUKTOR PRAWY	PUMP REDUCTOR RIGHT	НАСОС РЕДУКТОР ПРАВЫЙ
„+”	PRZEWÓD PRZEDŁUŻONY	EXTENDED BRAKE LINE	УДЛИНЁННАЯ ТОРМОЗНАЯ ТРУБКА
POM-ŁĄCZ P	POMPA ŁĄCZNIK PRZÓD	PUMP CONNECTOR FRONT	НАСОС СОЕДИНИТЕЛЬ ПЕРЕДНИЙ
POM-ŁĄCZ T	POMPA ŁĄCZNIK TYŁ	PUMP CONNECTOR REAR	НАСОС СОЕДИНИТЕЛЬ ЗАДНИЙ
KOST-TRÓJ	KOSTKA TRÓJNIK	BLOCK T-CONNECTOR	КУБИК ТРОЙНИК
KOST-RED	KOSTKA REDUKTOR	BLOCK REDUCTOR	КУБИК РЕДУКТОР
POM-ŁĄCZ	POMPA ŁĄCZNIK	PUMP CONNECTOR	НАСОС СОЕДИНИТЕЛЬ
KOR	KOREKTOR	CORRECTOR	КОРРЕКТОР
POM-SYG K	POMPA SYGNALIZATOR KRÓTKI	PUMP SIGNALER SHORT	НАСОС СИГНАЛИЗАТОР КОРОТКИЙ
POM-SYG D	POMPA SYGNALIZATOR DŁUGI	PUMP SIGNALER LONG	НАСОС СИГНАЛИЗАТОР ДЛИННЫЙ
SYG-KOS	SYGNALIZATOR KOSTKA	SIGNALER BLOCK	СИГНАЛИЗАТОР КУБИК
PP ROZ I OBW	PRZÓD PRAWY ROZDZIELACZ I OBWODU	FRONT RIGHT 1ST CIRCUIT DIVIDER	ФРОНТ ПРАВЫЙ РАСПРЕДЕЛИТЕЛЬ 1 КОНТУРА
PP ROZ II OBW	PRZÓD PRAWY ROZDZIELACZ II OBWODU	FRONT RIGHT 2ND CIRCUIT DIVIDER	ФРОНТ ПРАВЫЙ РАСПРЕДЕЛИТЕЛЬ 2 КОНТУРА
PL ROZ I OBW	PRZÓD LEWY ROZDZIELACZ I OBWODU	FRONT LEFT 1ST CIRCUIT DIVIDER	ФРОНТ ЛЕВЫЙ РАСПРЕДЕЛИТЕЛЬ 1 КОНТУРА
PL ROZ II OBW	PRZÓD LEWY ROZDZIELACZ II OBWODU	FRONT LEFT 2ND CIRCUIT DIVIDER	ФРОНТ ЛЕВЫЙ РАСПРЕДЕЛИТЕЛЬ 2 КОНТУРА
KOR-TRÓJ	KOREKTOR TRÓJNIK	CORRECTOR T-CONNECTOR	КОРРЕКТОР ТРОЙНИК
POM-ROZ I OBW	POMPA ROZDZIELACZ I OBWODU	PUMP DIVIDER 1ST CIRCUIT	НАСОС РАСПРЕДЕЛИТЕЛЬ 1 КОНТУРА
POM-ROZ II OBW	POMPA ROZDZIELACZ II OBWODU	PUMP DIVIDER 2ND CIRCUIT	НАСОС РАСПРЕДЕЛИТЕЛЬ 2 КОНТУРА
TM	TYŁ MOST	REAR BRIDGE	ЗАД МОСТ
POM-ABS	POMPA ABS	PUMP ABS	НАСОС-ABS
KOR-ABS	KOREKTOR ABS	CORRECTOR ABS	КОРРЕКТОР-ABS

*15	2xM10+2xM12 PRZY CYLINDRZE GŁÓWNYM	2xM10+2xM12 AT MAIN CYLINDER	2XM10+2XM12 ПРИ ГЛАВНОМ ЦИЛИНДРЕ
*16	4xM10 PRZY CYLINDRZE GŁÓWNYM	4xM10 AT MAIN CYLINDER	4XM10 ПРИ ГЛАВНОМ ЦИЛИНДРЕ
*17	BEZ HYDRALASTIC	WITHOUT HYDRALASTIC	БЕЗ HYDRALISTIC
*18	Z HYDRALASTIC	WITH HYDRALASTIC	С HYDRALISTIC
*19	JEDNOOBWODOWY SYSTEM HAMULCOWY	SINGLE-CIRCUIT BRAKE SYSTEM	ОДНОКОНТУРНАЯ ТОРМОЗНАЯ СИСТЕМА
*20	DWUOBWODOWY SYSTEM HAMULCOWY	DUAL-CIRCUIT BRAKE SYSTEM	ДВУХКОНТУРНАЯ ТОРМОЗНАЯ СИСТЕМА
*26	KABINA	COCKPIT	КАБИНА
*27	PODWÓJNA KABINA	DUAL COCKPIT	ДВОЙНАЯ КАБИНА
*31	SILNIK BENZYNOWY	GASOLINE ENGINE	БЕНЗИНОВЫЙ ДВИГАТЕЛЬ
*32	SILNIK NA OLEJ NAPĘDOWY (DIESEL)	DIESEL ENGINE	ДИЗЕЛЬНЫЙ ДВИГАТЕЛЬ
*33	SILNIK CZTEROCYLINDROWY	FOUR-CYLINDER ENGINE	ЧЕТЫРЬЦИЛИНДРОВЫЙ ДВИГАТЕЛЬ
*34	SILNIK PIĘCIOCYLINDROWY	FIVE-CYLINDER ENGINE	ПЯТИЦИЛИНДРОВЫЙ ДВИГАТЕЛЬ
*35	SILNIK SZCZĘŚCIOCYLINDROWY	SIX-CYLINDER ENGINE	ШЕСТИЦИЛИНДРОВЫЙ ДВИГАТЕЛЬ
*53	ZACISK HAMULCA Z DWOMA TŁOCZKAMI	TWO-PISTON BRAKE CALIPER	ДВУХПОРШНЕВАЯ СКОБА ТОРМОЗА
*54	ZACISK HAMULCA Z CZTEROMA TŁOCZKAMI	FOUR-PISTON BRAKE CALIPER	ЧЕТЫРЬПОРШНЕВАЯ СКОБА ТОРМОЗА
*55	NAPĘD PRZEDNI	FRONT-WHEEL DRIVE	ПЕРЕДНИЙ ПРИВОД
*56	WSPOMAGANIE KIEROWNICY	POWER STEERING	УСИЛИТЕЛЬ РУЛЯ
*56a	MINUS WSPOMAGANIE KIEROWNICY	MINUS POWER STEERING	БЕЗ УСИЛИТЕЛЯ РУЛЯ
*59	TARCZE HAMULCOWE PRZY SILNIKU	BRAKE DISC AT ENGINE	ТОРМОЗНЫЕ ДИСКИ ДВИГАТЕЛЯ
*60	TARCZE HAMULCOWE PRZY KOLE	BRAKE DISC AT WHEEL	ТОРМОЗНЫЕ ДИСКИ КОЛЕСА
*61	KOŁA 13-CALOWE	13-INCH WHEELS	13-ДУЙМОВЫЕ КОЛЕСА
*62	KOŁA 14-CALOWE	14-INCH WHEELS	14-ДУЙМОВЫЕ КОЛЕСА
*63	KOŁA POJEDYŃCZE	SINGLE WHEELS	ОДИНАРНЫЕ КОЛЕСА
*64	KOŁA PODWÓJNE	TWIN WHEELS	ДВОЙНЫЕ КОЛЕСА
*65	ROZSTAW KÓŁ	WHEEL TRACK	ГЕОМЕТРИЯ КОЛЕС
*66	Z HAMULCAMI BĘBNOWYMI Z TYŁU	WITH REAR DRUM BRAKES	С БАРАБАННЫМИ ТОРМОЗАМИ ЗАДНИХ КОЛЕС
*67	Z HAMULCAMI TARCZOWYMI Z TYŁU	WITH REAR DISC BRAKES	С ДИСКОВЫМИ ТОРМОЗАМИ ЗАДНИХ КОЛЕС
*68	Z HAMULCAMI BĘBNOWYMI Z PRZODU	WITH FRONT DRUM BRAKES	С БАРАБАННЫМИ ТОРМОЗАМИ ПЕРЕДНИХ КОЛЕС
*69	Z HAMULCAMI TARCZOWYMI Z PRZODU	WITH FRONT DISC BRAKES	С ДИСКОВЫМИ ТОРМОЗАМИ ПЕРЕДНИХ КОЛЕС
*71	BEZ WSPOMAGANIA HAMULCA	WITHOUT ASSISTED BRAKES	БЕЗ УСИЛИТЕЛЯ ТОРМОЗА
*72	ZE WSPOMAGANIEM HAMULCA	WITH ASSISTED BRAKES	С УСИЛИТЕЛЕМ ТОРМОЗА
*73	BEZ REGULATORY SIŁY HAMOWANIA	WITHOUT BRAKING FORCE REGULATOR	БЕЗ ТОРМОЗНОГО РЕГУЛЯТОРА
*74	Z REGULATOREM SIŁY HAMOWANIA	WITH BRAKING FORCE REGULATOR	С ТОРМОЗНЫМ РЕГУЛЯТОРОМ
*75	ZŁĄCZKA MUSI ZOSTAĆ ZAMONTOWANA W ZAWORZE ZACISKU HAMULCA	CONNECTOR MUST BE MOUNTED IN BRAKE CALIPER VALVE	СКРЕПЛЕНИЕ НЕОБХОДИМО УСТАНОВИТЬ В КЛАПАНЕ СКОБЫ ТОРМОЗА
*76	Z REGULATOREM HAMULCA Z LEWEJ STRONY	WITH BRAKE REGULATOR ON LEFT SIDE	С ТОРМОЗНЫМ РЕГУЛЯТОРОМ С ЛЕВОЙ СТОРОНЫ
*77	Z REGULATOREM HAMULCA POŚRODKU	WITH BRAKE REGULATOR IN THE MIDDLE	С ТОРМОЗНЫМ РЕГУЛЯТОРОМ ПОСЕРЕДИНЕ
*80	Z GWINTEM MILIMETROWYM	WITH MILLIMETER THREAD	С МИЛЛИМЕТРОВОЙ РЕЗЬБОЙ
*81	Z GWINTEM CALOWYM	WITH INCH THREAD	С ДЮЙМОВОЙ РЕЗЬБОЙ
*82	Z ROZDZIELACZEM TRÓJŻYŁOWYM	WITH THREE-CORE DISTRIBUTOR	С ТРЁХПРОВОДНЫМ РАСПРЕДЕЛИТЕЛЕМ
*83	Z ROZDZIELACZEM PIĘCIOŻYŁOWYM	WITH FIVE-CORE DISTRIBUTOR	С ПЯТИПРОВОДНЫМ РАСПРЕДЕЛИТЕЛЕМ
*84	Z ROZDZIELACZEM NA OSI PRZEDNIEJ	WITH DISTRIBUTOR ON FRONT AXLE	С РАСПРЕДЕЛИТЕЛЕМ НА ПЕРЕДНЕЙ ОСИ
*85	BEZ ROZDZIELACZA	WITHOUT DISTRIBUTOR	БЕЗ РАСПРЕДЕЛИТЕЛЯ
*86	Z ROZDZIELACZEM	WITH DISTRIBUTOR	С РАСПРЕДЕЛИТЕЛЕМ
*89	Z NAPRZEMIANLEGŁYM SYSTEMEM HAMULCOWYM	WITH DIAGONAL BRAKE SYSTEM	С ПЕРЕКРЁСТНОЙ ТОРМОЗНОЙ СИСТЕМОЙ
*90	MINUS NAPRZEMIANLEGŁY SYSTEM HAMULCOWY	MINUS DIAGONAL BRAKE SYSTEM	БЕЗ ПЕРЕКРЁСТНОЙ ТОРМОЗНОЙ СИСТЕМЫ

Przewody hamulcowe

sortowane wg marek i modeli

Brake lines

sorted by brand and model

Поиск тормозных трубок

по марке и модели автомобиля

**Wszystkie prezentowane w katalogu przewody produkowane są z miedzi.
Na życzenie klienta każdy z nich może zostać wykonany ze stali lub miedzio-niklu.**

**All brake lines presented in this catalogue are made of copper.
Each brake lines can be alternatively made of steel (in PVF coating) or copper-nickel
- upon customers' request.**

**Все представленные в каталоге трубки по умолчанию сделаны из меди. По желанию
клиента любую из них можно изготовить из стали или
медно-никелевого сплава.**

MARKA SAMOCHODU
CAR MODEL
МОДЕЛЬ АВТОМБИЯ

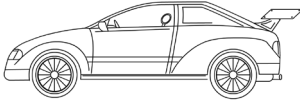

NUMER ZESTAWU
SET NUMBER
НОМЕР НАБОРА

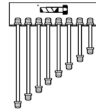

ROK PRODUKCJI
PRODUCTION YEAR
ГОД ВЫПУСКА АВТОМБИЯ



ODPOWIETRZNIK
BLEEDER SCREW
ШТУЦЕР ПРОКАЧКИ ТОРМОЗОВ

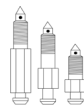

INDEKS
INDEX
ИНДЕКС



POŁOŻENIE
LOCATION
МЕСТО

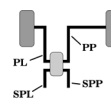

OPIS
DESCRIPTION
ОПИСАНИЕ

ZŁĄCZKA ZŁĄCZKA DŁUGOŚĆ
FITTING FITTING LENGTH
НАКОНЕЧНИК НАКОНЕЧНИК ДЛИНА

MARKA SAMOCHODU CAR MODEL МОДЕЛЬ АВТОМБИЯ	NUMER ZESTAWU SET NUMBER НОМЕР НАБОРА	ROK PRODUKCJI PRODUCTION YEAR ГОД ВЫПУСКА АВТОМБИЯ	ODPOWIETRZNIK BLEEDER SCREW ШТУЦЕР ПРОКАЧКИ ТОРМОЗОВ	INDEKS INDEX ИНДЕКС	POŁOŻENIE LOCATION МЕСТО	OPIS DESCRIPTION ОПИСАНИЕ				
ALFA ROMEO Alfasud										
Wszystkie modele All models Все модели	ZWP-5001	09.71>83	0053P	WP-005	ZPL	105 105 0450				
				WP-005	ZPP	105 105 0450				
				WP-041	PL	105 105 0350				
				WP-002	PP	105 105 0850				
				WP-003	TL	105 105 1400				
				WP-004	SP	105 105 3100				
				WP-001	ST	105 105 0300				
				0053T						
ALFA ROMEO Alfetta										
1600GT, 1800GTV, 2000GTV	ZWP-5002	05.72>83	0086P	WP-045	ZPL	105 105 0400				
				WP-045	ZPP	105 105 0400				
				WP-101	PL	105 106 0200				
				WP-195	PP	105 106 0700				
				WP-207	TL	105 106 1600				
				WP-448	TP	105 106 0850				
				WP-433	CC	105 105 2950				
				0053T						
ALFA ROMEO 33										
Wszystkie modele All models Все модели	ZWP-5003	83>86	0069P 0100P 0100T 0053T	WP-110	PL	105 106 0550				
				WP-104	PP	105 106 1000				
				WP-039	TL	105 105 1550				
				WP-043	TP	105 105 0200				
				WP-589	CL	104 105 3150				
				WP-432	CP	105 105 3250				
				ALFA ROMEO 145						
				Wszystkie modele z ABS, do Nr 3174687 All models with ABS, to no. 3174687 Все модели с ABS, к нет. 3174687	ZWP-5004	01.97>02.99	0015P 0100T	WP-435	PL	105 105 1600
WP-023	PP	105 105 1800								
WP-314	TL	104 105 1000								
WP-314	TP	104 105 1000								
WP-314	SPL	104 105 1000								
WP-1680	SPP	105 110X 1050								
WP-031	CL	105 105 2200								
WP-1703	CP	110X 110X 2250								
WP-1670	STL	104 110X 0600								
WP-018	STP	105 105 0650								
ALFA ROMEO 145										
Wszystkie modele z ABS, od Nr 3174688- All models with ABS, from no. 3174688- Все модели с ABS, от нет. 3174688-	ZWP-5005	01.97>02.99	0015P 0100T					WP-435	PL	105 105 1600
				WP-023	PP	105 105 1800				
				WP-196	TL	105 105 1300				
				WP-196	TP	105 105 1300				
				WP-1679	SPL	105 110X 1000				
				WP-314	SPP	104 105 1000				
				WP-440	CL	105 105 2150				
				WP-1702	CP	110X 110X 2150				
				WP-1670	STL	104 110X 0600				
				WP-018	STP	105 105 0650				
				ALFA ROMEO 146						
				1.4, 1.6 z ABS do Nr 3174687 with ABS, to no. 3174687 с ABS, к нет. 3174687	ZWP-5004	01.97>02.99	0015P 0100T	WP-435	PL	105 105 1600
WP-023	PP	105 105 1800								
WP-314	TL	104 105 1000								
WP-314	TP	104 105 1000								
WP-314	SPL	104 105 1000								
WP-1680	SPP	105 110X 1050								
WP-031	CL	105 105 2200								
WP-1703	CP	110X 110X 2250								
WP-1670	STL	104 110X 0600								
WP-018	STP	105 105 0650								
ALFA ROMEO 146										
1.4, 1.6 z ABS od Nr 3174688 with ABS, from no. 3174688 с ABS, от нет. 3174688	ZWP-5007	01.97>02.99	0015P 0100T					WP-035	PL	105 105 1100
				WP-023	PP	105 105 1800				
				WP-196	TL	105 105 1300				
				WP-196	TP	105 105 1300				
				WP-314	SPL	104 105 1000				
				WP-1680	SPP	105 110X 1050				
				WP-031	CL	105 105 2200				
				WP-1703	CP	110X 110X 2250				
				WP-1670	STL	104 110X 0600				
				WP-018	STP	105 105 0650				
				ALFA ROMEO 146						
				2.0 z ABS with ABS с ABS	ZWP-5008	01.97>02.99	0015P 0100T	WP-435	PL	105 105 1600
WP-023	PP	105 105 1800								
WP-196	TL	105 105 1300								
WP-196	TP	105 105 1300								
WP-314	SPL	104 105 1000								
WP-1680	SPP	105 110X 1050								
WP-031	CL	105 105 2200								
WP-1703	CP	110X 110X 2250								
WP-1670	STL	104 110X 0600								
WP-018	STP	105 105 0650								

MARKA SAMOCHODU
CAR MODEL
МОДЕЛЬ АВТОМБИЯ

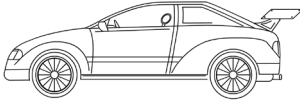

NUMER ZESTAWU
SET NUMBER
НОМЕР НАБОРА

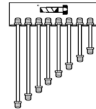

ROK PRODUKCJI
PRODUCTION YEAR
ГОД ВЫПУСКА АВТОМБИЯ



ODPOWIETRZNIK
BLEEDER SCREW
ШТУЦЕР ПРОКАЧКИ ТОРМОЗОВ

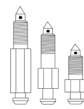

INDEKS
INDEX
ИНДЕКС



POŁOŻENIE
LOCATION
МЕСТО

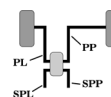

OPIS
DESCRIPTION
ОПИСАНИЕ

ZŁĄCZKA ZŁĄCZKA DŁUGOŚĆ
FITTING FITTING LENGTH
НАКОНЕЧНИК НАКОНЕЧНИК ДЛИНА

MARKA SAMOCHODU CAR MODEL МОДЕЛЬ АВТОМБИЯ	NUMER ZESTAWU SET NUMBER НОМЕР НАБОРА	ROK PRODUKCJI PRODUCTION YEAR ГОД ВЫПУСКА АВТОМБИЯ	ODPOWIETRZNIK BLEEDER SCREW ШТУЦЕР ПРОКАЧКИ ТОРМОЗОВ	INDEKS INDEX ИНДЕКС	POŁOŻENIE LOCATION МЕСТО	OPIS DESCRIPTION ОПИСАНИЕ
ALFA ROMEO 147						
Wszystkie modele z ABS All models with ABS Все модели с ABS	ZWP-5009	01.01<	0015P	WP-252	PL	105 105 1050
				WP-010	PP	105 105 1850
				WP-1685	TL	105 110X 2750
				WP-046	TP	105 105 3500
				WP-1681	STL	105 110X 1150
			0039T	WP-254	STP	104 105 1150
ALFA ROMEO 156						
Wszystkie modele z ABS All models with ABS Все модели с ABS	ZWP-5010	10.97<08.05	0015P	WP-115	PL	105 105 1150
				WP-023	PP	105 105 1800
				WP-1686	TL	105 110X 2800
				WP-020	TP	105 105 3400
				WP-115	STL	105 105 1150
			0039T	WP-1701	STP	104X 110X 1200
AUDI 50						
Wszystkie modele od Nr 8672376929 All models from no. 8672376929 Все модели от нет. 8672376929	ZWP-5101	11.76>08.1	0086P	WP-009	PL	105 105 0600
				WP-010	PP	105 105 1850
				WP-117	TL	105 105 0750
				WP-022	TP	105 105 1350
				WP-001	ZTL	105 105 0300
				WP-001	ZTP	105 105 0300
				WP-014	CL	105 105 2400
					0013T	WP-167
*72						
*74						
AUDI 50						
Wszystkie modele All models Все модели	ZWP-5102	75>07.78	0086P	WP-005	PL	105 105 0450
				WP-003	PP	105 105 1400
				WP-001	TL	105 105 0300
				WP-001	TP	105 105 0300
				WP-008	CL	105 105 3000
	0013T	WP-007	CP	105 105 3900		
*71						
*73						
AUDI 50						
Wszystkie modele All models Все модели	ZWP-5103	75>07.78	0086P	WP-009	PL	105 105 0600
				WP-010	PP	105 105 1850
				WP-001	TL	105 105 0300
				WP-001	TP	105 105 0300
				WP-004	CL	105 105 3100
	0013T	WP-007	CP	105 105 3900		
*72						
*73						
AUDI 50						
Wszystkie modele, Nr 8672376929 All models, no.8672376929 Все модели, нет.8672376929	ZWP-5104	11.76>08.81	0086P	WP-005	PL	105 105 0450
				WP-003	PP	105 105 1400
				WP-117	TL	105 105 0750
				WP-022	TP	105 105 1350
				WP-001	ZTL	105 105 0300
				WP-001	ZTP	105 105 0300
				WP-390	CL	105 105 2250
					0013T	WP-048
*71						
*74						
AUDI 80						
Sedan	ZWP-5105	08.77>07.78	0086P	WP-117	PL	105 105 0750
				WP-019	PP	105 105 1000
				WP-196	TL	105 105 1300
				WP-009	TP	105 105 0600
				WP-017	ZTL	105 105 0500
				WP-017	ZTP	105 105 0500
				WP-021	CL	105 105 3600
					0013T	WP-571
*74						
AUDI 80						
Variant bez ABS Variant without ABS Variant без ABS	ZWP-5106	08.77>07.78	0086P	WP-117	PL	105 105 0750
				WP-019	PP	105 105 1000
				WP-023	TL	105 105 1800
				WP-013	TP	105 105 0900
				WP-017	ZTL	105 105 0500
				WP-017	ZTP	105 105 0500
				WP-025	CL	105 105 4300
					0013T	WP-025
*74						
AUDI 80						
Wszystkie modele All models Все модели	ZWP-5107	08.78>07.84	0086P	WP-024	PL	105 105 0800
				WP-027	PP	105 105 1250
				WP-042	TL	105 105 1700
				WP-028	TP	105 105 0550
				WP-017	ZTL	105 105 0500
				WP-017	ZTP	105 105 0500
				WP-021	CL	105 105 3600
					0013T	WP-007
*74						
AUDI 80						
Wszystkie modele, Nr 81-F-000001>81-H-299999 All models, no.81-F-000001>81-H-299999 Все модели, нет.81-F-000001>81-H-299999	ZWP-5108	08.84>07.86	0086P	WP-024	PL	105 105 0800
				WP-027	PP	105 105 1250
				WP-049	TL	105 105 1900
				WP-018	TP	105 105 0650
				WP-017	ZTL	105 105 0500
				WP-017	ZTP	105 105 0500
				WP-534	CL	105 105 3750
					0013T	WP-025
*66						
*74						

MARKA SAMOCHODU
CAR MODEL
МОДЕЛЬ АВТОМБИЯ

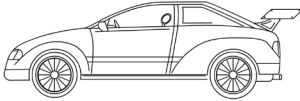

NUMER ZESTAWU
SET NUMBER
НОМЕР НАБОРА

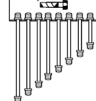

ROK PRODUKCJI
PRODUCTION YEAR
ГОД ВЫПУСКА АВТОМБИЯ



ODPOWIETRZNIK
BLEEDER SCREW
ШТУЦЕР ПРОКАЧКИ ТОРМОЗОВ

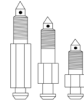

INDEKS
INDEX
ИНДЕКС



POŁOŻENIE
LOCATION
МЕСТО

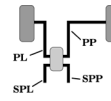

OPIS
DESCRIPTION
ОПИСАНИЕ

ZŁĄCZKA FITTING
НАКОНЕЧНИК
ZŁĄCZKA FITTING
НАКОНЕЧНИК
DŁUGOŚĆ LENGTH
ДЛИНА

AUDI 80							
Wszystkie modele, Nr 81-F-000001>81-H-299999 All models, no.81-F-000001>81-H-299999 Все модели, нет.81-F-000001>81-H-299999 *67 *74	ZWP-5109	08.84>07.86	0087P	WP-024	PL	105 105 0800	
				WP-027	PP	105 105 1250	
				WP-049	TL	105 105 1900	
				WP-018	TP	105 105 0650	
				WP-001	ZTL	105 105 0300	
				WP-001	ZTP	105 105 0300	
				WP-534	CL	105 105 3750	
				WP-025	CP	105 105 4300	
AUDI 80							
Wszystkie modele z ABS, Nr 89-H-300001>8A-L-038655 All models with ABS, no.89-H-300001>8A-L-038655 Все модели с ABS, нет.89-H-300001>8A-L-038655 *74	ZWP-5110	08.86>08.89	0087P	WP-010	PL	105 105 1850	
				WP-009	PP	105 105 0600	
				WP-039	TL	105 105 1550	
				WP-009	TP	105 105 0600	
				WP-001	ZTL	105 105 0300	
				WP-001	ZTP	105 105 0300	
				WP-252	SPL	105 105 1050	
				WP-019	SPP	105 105 1000	
				WP-433	STL	105 105 2950	
				WP-008	STP	105 105 3000	
				0013T 0087T			
AUDI 80							
Wszystkie modele bez ABS, Nr 89-H-300001>8A-L-038655 All models without ABS, no.89-H-300001>8A-L-038655 Все модели без ABS, нет.89-H-300001>8A-L-038655 *74	ZWP-5111	08.86>08.89	0087P	WP-018	PL	105 105 0650	
				WP-115	PP	105 105 1150	
				WP-039	TL	105 105 1550	
				WP-009	TP	105 105 0600	
				WP-001	ZTL	105 105 0300	
				WP-001	ZTP	105 105 0300	
				WP-019	SPL	105 105 1000	
				WP-252	SPP	105 105 1050	
				WP-433	STL	105 105 2950	
				WP-008	STP	105 105 3000	
				0013T 0087T			
AUDI 80							
Wszystkie modele z ABS, Nr 8A-L-000001>8A-N-200000 All models with ABS, no.8A-L-000001>8A-N-200000 Все модели с ABS, нет.8A-L-000001>8A-N-200000 *74	ZWP-5112	09.89>12.91	0087P	WP-043	ZPL	105 105 0200	
				WP-043	ZPP	105 105 0200	
				WP-010	PL	105 105 1850	
				WP-009	PP	105 105 0600	
				WP-039	TL	105 105 1550	
				WP-009	TP	105 105 0600	
				WP-001	ZTL	105 105 0300	
				WP-001	ZTP	105 105 0300	
				WP-019	SPL	105 105 1000	
				WP-252	SPP	105 105 1050	
				WP-433	STL	105 105 2950	
				WP-008	STP	105 105 3000	
				0087T 0013T			
				AUDI 80			
Wszystkie modele bez ABS, Nr 8A-L-03656>8A-L-200000 All models without ABS, no.8A-L-03656>8A-L-200000 Все модели без ABS, нет.8A-L-03656>8A-L-200000 *74	ZWP-5113	09.89>08.91	0087P	WP-043	ZPL	105 105 0200	
				WP-043	ZPP	105 105 0200	
				WP-009	PL	105 105 0600	
				WP-435	PP	105 105 1600	
				WP-039	TL	105 105 1550	
				WP-009	TP	105 105 0600	
				WP-001	ZTL	105 105 0300	
				WP-001	ZTP	105 105 0300	
				WP-019	SPL	105 105 1000	
				WP-252	SPP	105 105 1050	
				WP-433	STL	105 105 2950	
				WP-008	STP	105 105 3000	
				0087T 0013T			
				AUDI 80			
Wszystkie modele z ABS, Nr 8C-N-000001>8C-T-010000 All models with ABS, no.8C-N-000001>8C-T-010000 Все модели с ABS, нет.8C-N-000001>8C-T-010000 *74	ZWP-5114	09.91>07.95	0087P	WP-043	ZPL	105 105 0200	
				WP-043	ZPP	105 105 0200	
				WP-033	PL	105 105 0700	
				WP-036	PP	105 105 2100	
				WP-356	TL	105 105 1450	
				WP-356	TP	105 105 1450	
				WP-005	ZTL	105 105 0450	
				WP-005	ZTP	105 105 0450	
				WP-196	SPL	105 105 1300	
				WP-022	SPP	105 105 1350	
				WP-023	STL	105 105 1800	
				WP-010	STP	105 105 1850	
				0013T 0087T			

MARKA SAMOCHODU
CAR MODEL
МОДЕЛЬ АВТОМБИЯ

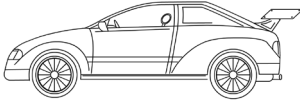

NUMER ZESTAWU
SET NUMBER
НОМЕР НАБОРА

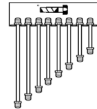

ROK PRODUKCJI
PRODUCTION YEAR
ГОД ВЫПУСКА АВТОМБИЯ



ODPOWIETRZNIK
BLEEDER SCREW
ШТУЦЕР ПРОКАЧКИ ТОРМОЗОВ

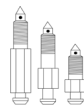

INDEKS
INDEX
ИНДЕКС



POŁOŻENIE
LOCATION
МЕСТО

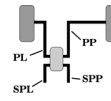

OPIS
DESCRIPTION
ОПИСАНИЕ

ZŁĄCZKA ZŁĄCZKA DŁUGOŚĆ
FITTING FITTING LENGTH
НАКОНЕЧНИК НАКОНЕЧНИК ДЛИНА

MARKA SAMOCHODU CAR MODEL МОДЕЛЬ АВТОМБИЯ	NUMER ZESTAWU SET NUMBER НОМЕР НАБОРА	ROK PRODUKCJI PRODUCTION YEAR ГОД ВЫПУСКА АВТОМБИЯ	ODPOWIETRZNIK BLEEDER SCREW ШТУЦЕР ПРОКАЧКИ ТОРМОЗОВ	INDEKS INDEX ИНДЕКС	POŁOŻENIE LOCATION МЕСТО	OPIS DESCRIPTION ОПИСАНИЕ			
AUDI 80									
Wszystkie modele bez ABS, Nr 8C-N-000001>8C-T-010000 All models without ABS, no.8C-N-000001>8C-T-010000 Все модели без ABS, нет.8C-N-000001>8C-T-010000	ZWP-5115	09.91>07.95	0087P	WP-043	ZPL	105 105 0200			
				WP-043	ZPP	105 105 0200			
				WP-009	PL	105 105 0600			
				WP-047	PP	105 105 1500			
				WP-356	TL	105 105 1450			
				WP-356	TP	105 105 1450			
				WP-005	ZTL	105 105 0450			
				WP-005	ZTP	105 105 0450			
				WP-019	SPL	105 105 1000			
				WP-252	SPP	105 105 1050			
				WP-023	STL	105 105 1800			
				WP-023	STP	105 105 1800			
				*33			0087T		
*66			0013T						
*74									
AUDI 80									
Wszystkie modele All models Все модели	ZWP-5116	10.74>07.77	0087P	WP-117	PL	105 105 0750			
				WP-019	PP	105 105 1000			
				WP-017	TL	105 105 0500			
				WP-017	TP	105 105 0500			
				WP-708	CL	105 105 2850			
				WP-020	CP	105 105 3400			
				*72			0087T		
*73			0013T						
AUDI 80									
Sedan	ZWP-5117	08.77>07.78	0087P	WP-117	PL	105 105 0750			
				WP-019	PP	105 105 1000			
				WP-017	ZTL	105 105 0500			
				WP-017	ZTP	105 105 0500			
				WP-032	CL	105 105 2800			
				WP-020	CP	105 105 3400			
*73			0087T						
			0013T						
AUDI 80									
Wszystkie modele All models Все модели	ZWP-5118	08.78>10.81	0087P	WP-024	PL	105 105 0800			
				WP-027	PP	105 105 1250			
				WP-017	ZTL	105 105 0500			
				WP-017	ZTP	105 105 0500			
				WP-008	CL	105 105 3000			
				WP-021	CP	105 105 3600			
*73			0087T						
			0013T						
AUDI 80									
Wszystkie modele All models Все модели	ZWP-5119	11.81>07.84	0087P	WP-024	PL	105 105 0800			
				WP-027	PP	105 105 1250			
				WP-028	ZTL	105 105 0550			
				WP-028	ZTP	105 105 0550			
				WP-029	CL	105 105 3200			
				WP-021	CP	105 105 3600			
*73			087T						
			0013T						
AUDI 80									
Wszystkie modele, Nr 81-F-000001>81-H-299999 All models, Nr 81-F-000001>81-H-299999 Все модели, Nr 81-F-000001>81-H-299999	ZWP-5119	08.8>07.86	0087P	WP-024	PL	105 105 0800			
				WP-027	PP	105 105 1250			
				WP-028	ZTL	105 105 0550			
				WP-028	ZTP	105 105 0550			
				WP-029	CL	105 105 3200			
				WP-021	CP	105 105 3600			
*73			0087T						
			0013T						
AUDI 90									
Wszystkie modele, Nr 81-F-000001>81-H-299999 All models, Nr 81-F-000001>81-H-299999 Все модели, Nr 81-F-000001>81-H-299999	ZWP-5108	08.84>08.86	0087P	WP-024	PL	105 105 0800			
				WP-027	PP	105 105 1250			
				WP-049	TL	105 105 1900			
				WP-018	TP	105 105 0650			
				WP-017	ZTL	105 105 0500			
				WP-017	ZTP	105 105 0500			
				WP-534	CL	105 105 3750			
				WP-025	CP	105 105 4300			
				*66			0087T		
				*74			0013T		
AUDI 90									
Wszystkie modele, Nr 81-F-000001>81-H-299999 All models, Nr 81-F-000001>81-H-299999 Все модели, Nr 81-F-000001>81-H-299999	ZWP-5109	08.84>08.86	0087P	WP-024	PL	105 105 0800			
				WP-027	PP	105 105 1250			
				WP-049	TL	105 105 1900			
				WP-018	TP	105 105 0650			
				WP-001	ZTL	105 105 0300			
				WP-001	ZTP	105 105 0300			
				WP-534	CL	105 105 3750			
				WP-025	CP	105 105 4300			
				*67			0087T		
				*74			0013T		
AUDI 90									
Wszystkie modele z ABS, Nr 89-H-300001>8A-L-038655 All models with ABS, no.89-H-300001>8A-L-038655 Все модели с ABS, нет.89-H-300001>8A-L-038655	ZWP-5110	08.86>08.89	0087P	WP-010	PL	105 105 1850			
				WP-009	PP	105 105 0600			
				WP-039	TL	105 105 1550			
				WP-009	TP	105 105 0600			
				WP-001	ZTL	105 105 0300			
				WP-001	ZTP	105 105 0300			
				WP-252	SPL	105 105 1050			
				WP-019	SPP	105 105 1000			
				WP-433	STL	105 105 2950			
				WP-008	STP	105 105 3000			
*74			0087T						
			0013T						

MARKA SAMOCHODU
CAR MODEL
МОДЕЛЬ АВТОМБИЯ

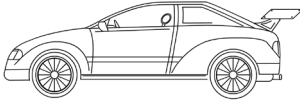

NUMER ZESTAWU
SET NUMBER
НОМЕР НАБОРА

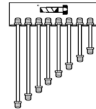

ROK PRODUKCJI
PRODUCTION YEAR
ГОД ВЫПУСКА АВТОМБИЯ



ODPOWIETRZNIK
BLEEDER SCREW
ШТУЦЕР ПРОКАЧКИ ТОРМОЗОВ

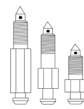

INDEKS
INDEX
ИНДЕКС



POŁOŻENIE
LOCATION
МЕСТО

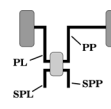

OPIS
DESCRIPTION
ОПИСАНИЕ

ZŁĄCZKA
FITTING
НАКОНЕЧНИК

ZŁĄCZKA
FITTING
НАКОНЕЧНИК

DŁUGOŚĆ
LENGTH
ДЛИНА

MARKA SAMOCHODU CAR MODEL МОДЕЛЬ АВТОМБИЯ	NUMER ZESTAWU SET NUMBER НОМЕР НАБОРА	ROK PRODUKCJI PRODUCTION YEAR ГОД ВЫПУСКА АВТОМБИЯ	ODPOWIETRZNIK BLEEDER SCREW ШТУЦЕР ПРОКАЧКИ ТОРМОЗОВ	INDEKS INDEX ИНДЕКС	POŁOŻENIE LOCATION МЕСТО	OPIS DESCRIPTION ОПИСАНИЕ				
AUDI 90										
Wszystkie modele bez ABS, Nr 89-H-300001>8A-L-038655 All models without ABS, no.89-H-300001>8A-L-038655 Все модели без ABS, нет.89-H-300001>8A-L-038655	ZWP-5111	08.86>08.89	0087P	WP-018	PL	105 105 0650				
				WP-115	PP	105 105 1150				
				WP-039	TL	105 105 1550				
				WP-009	TP	105 105 0600				
				WP-001	ZTL	105 105 0300				
				WP-001	ZTP	105 105 0300				
				WP-019	SPL	105 105 1000				
				WP-252	SPP	105 105 1050				
				WP-433	STL	105 105 2950				
				WP-008	STP	105 105 3000				
				*74	0087T	0013T				
				AUDI 90						
				Wszystkie modele z ABS, Nr 8A-L-038656>8A-N-200000 All models with ABS, no.8A-L-038656>8A-N-200000 Все модели с ABS, нет.8A-L-038656>8A-N-200000	ZWP-5112	09.89>12.91	0087P	WP-043	ZPL	105 105 0200
WP-043	ZPP	105 105 0200								
WP-010	PL	105 105 1850								
WP-009	PP	105 105 0600								
WP-039	TL	105 105 1550								
WP-009	TP	105 105 0600								
WP-001	ZTL	105 105 0300								
WP-001	ZTP	105 105 0300								
WP-019	SPL	105 105 1000								
WP-252	SPP	105 105 1050								
WP-433	STL	105 105 2950								
WP-008	STP	105 105 3000								
*74	0087T	0013T								
AUDI 90										
Wszystkie modele bez ABS, Nr 8A-L-038656>8A-N-200000 All models without ABS, no.8A-L-038656>8A-N-200000 Все модели без ABS, нет.8A-L-038656>8A-N-200000	ZWP-5113	09.89>12.91	0087P	WP-043	ZPL	105 105 0200				
				WP-043	ZPP	105 105 0200				
				WP-009	PL	105 105 0600				
				WP-435	PP	105 105 1600				
				WP-039	TL	105 105 1550				
				WP-009	TP	105 105 0600				
				WP-001	ZTL	105 105 0300				
				WP-001	ZTP	105 105 0300				
				WP-019	SPL	105 105 1000				
				WP-252	SPP	105 105 1050				
				WP-433	STL	105 105 2950				
				WP-008	STP	105 105 3000				
				*74	0087T	0013T				
AUDI 90										
Wszystkie modele, Nr 81-F-000001>81-H-299999 All models, no.81-F-000001>81-H-299999 Все модели, нет.81-F-000001>81-H-299999	ZWP-5119		0087P	WP-024	PL	105 105 0800				
				WP-027	PP	105 105 1250				
				WP-028	ZTL	105 105 0550				
				WP-028	ZTP	105 105 0550				
				WP-029	CL	105 105 3200				
				WP-021	CP	105 105 3600				
*73	0087T	0013T								
AUDI 100										
S, LS, GLS	ZWP-5123	06.76>07.78	0086P	WP-017	PL	105 105 0500				
				WP-003	PP	105 105 1400				
				WP-045	TL	105 105 0400				
				WP-005	TL+	105 105 0450				
				WP-043	TP	105 105 0200				
				WP-039	TP+	105 105 1550				
				WP-040	CL	105 105 3300				
				WP-046	CP	105 105 3500				
*33	0013T									
AUDI 100										
L, GL Nr 43720000001>43-C-100000	ZWP-5124	08.77>07.82	0086P	WP-017	PL	105 105 0500				
				WP-003	PP	105 105 1400				
				WP-005	TL	105 105 0450				
				WP-043	TP	105 105 0200				
				WP-004	CL	105 105 3100				
				WP-044	CP	105 105 4800				
*33	0013T									
AUDI 100										
Wszystkie modele All models Все модели	ZWP-5123	03.77>07.82	0086P	WP-017	PL	105 105 0500				
				WP-003	PP	105 105 1400				
				WP-045	TL	105 105 0400				
				WP-005	TL+	105 105 0450				
				WP-043	TP	105 105 0200				
				WP-039	TP+	105 105 1550				
				WP-040	CL	105 105 3300				
				WP-046	CP	105 105 3500				
*34	0013T									
AUDI 100										
Limousine 1.9L, CC, CD, CS bez wspomagania kierownicy without power steering без усилителя руля	ZWP-5125	08.82>12.85	0086P	WP-001	ZPL	105 105 0300				
				WP-001	ZPP	105 105 0300				
				WP-017	PL	105 105 0500				
				WP-003	PP	105 105 1400				
				WP-018	TL	105 105 0650				
				WP-039	TP	105 105 1550				
				WP-006	ZTL	105 105 0250				
				WP-006	ZTP	105 105 0250				
				WP-029	CL	105 105 3200				
				WP-016	CP	105 105 2900				
				*33	0013T					
*34										

MARKA SAMOCHODU
CAR MODEL
МОДЕЛЬ АВТОМБИЯ

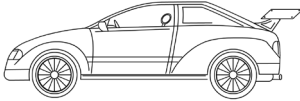

NUMER ZESTAWU
SET NUMBER
НОМЕР НАБОРА

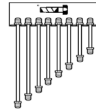

ROK PRODUKCJI
PRODUCTION YEAR
ГОД ВЫПУСКА АВТОМБИЯ



ODPOWIETRZNIK
BLEEDER SCREW
ШТУЦЕР ПРОКАЧКИ ТОРМОЗОВ

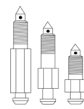

INDEKS
INDEX
ИНДЕКС



POŁOŻENIE
LOCATION
МЕСТО

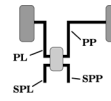

OPIS
DESCRIPTION
ОПИСАНИЕ

ZŁĄCZKA
FITTING
НАКОНЕЧНИК

ZŁĄCZKA
FITTING
НАКОНЕЧНИК

DŁUGOŚĆ
LENGTH
ДЛИНА

AUDI 100							
Limousine, Avant 2.2L, Diesel bez wspomagania kierownicy without power steering без усилителя руля *34	ZWP-5126	08.82>12.85	0086P	WP-001	ZPL	105 105 0300	
				WP-001	ZPP	105 105 0300	
				WP-028	PL	105 105 0550	
				WP-003	PP	105 105 1400	
				WP-018	TL	105 105 0650	
				WP-039	TP	105 105 1550	
				WP-006	ZTL	105 105 0250	
				WP-006	ZTP	105 105 0250	
				WP-040	CL	105 105 3300	
				WP-040	CP	105 105 3300	
0013T							
0087T							
AUDI 100							
Limousine, Avant, Diesel wspomaganie kierownicy power steering усилитель руля *34	ZWP-5127	08.82>12.85	0086P	WP-001	ZPL	105 105 0300	
				WP-001	ZPP	105 105 0300	
				WP-017	PL	105 105 0500	
				WP-003	PP	105 105 1400	
				WP-018	TL	105 105 0650	
				WP-039	TP	105 105 1550	
				WP-006	ZTL	105 105 0250	
				WP-006	ZTP	105 105 0250	
				WP-029	CL	105 105 3200	
				WP-029	CP	105 105 3200	
0013T							
0087T							
AUDI 100							
Limousine, Avant Nr 44-G-073363>44-J-200099 *66	ZWP-5128	01.86>12.87	0086P	WP-001	ZPL	105 105 0300	
				WP-001	ZPP	105 105 0300	
				WP-028	PL	105 105 0550	
				WP-003	PP	1051501400	
				WP-017	TL	105 105 0500	
				WP-018	TL+	105 105 0650	
				WP-013	TP	105 105 0900	
				WP-390	TP+	105 105 2250	
				WP-029	CL	105 105 3200	
				WP-040	CP	105 105 3300	
0013T							
0087T							
AUDI 100							
Limousine, Avant Nr 44-G-073363>44-J-200099 *67	ZWP-5129	01.86>12.87	0086P	WP-001	ZPL	105 105 0300	
				WP-001	ZPP	105 105 0300	
				WP-028	PL	105 105 0550	
				WP-003	PP	105 105 1400	
				WP-017	TL	105 105 0500	
				WP-390	TP	105 105 2250	
				WP-013	ZTL	105 105 0900	
				WP-013	ZTP	105 105 0900	
				WP-029	CL	105 105 3200	
				WP-040	CP	105 105 3300	
0013T							
0087T							
AUDI 100							
Limousine, Avant Nr 44-J-200100>44-K-150000 bez ABS without ABS без ABS *66	ZWP-5130	01.88>07.89	0086P	WP-001	ZPL	105 105 0300	
				WP-001	ZPP	105 105 0300	
				WP-028	PL	105 105 0550	
				WP-047	PP	105 105 1500	
				WP-017	TL	105 105 0500	
				WP-559	TP	105 105 2350	
				WP-013	ZTL	105 105 0900	
				WP-013	ZTP	105 105 0900	
				WP-029	CL	105 105 3200	
				WP-040	CP	105 105 3300	
0087T							
0013T							
AUDI 100							
Limousine, Avant Nr 44-J-200100>4-K-150000 z ABS with ABS c ABS *66	ZWP-5131	01.88>07.89	0086P	WP-001	ZPL	105 105 0300	
				WP-001	ZPP	105 105 0300	
				WP-017	PL	105 105 0500	
				WP-435	PP	105 105 1600	
				WP-017	TL	105 105 0500	
				WP-559	TP	105 105 2350	
				WP-013	ZTL	105 105 0900	
				WP-013	ZTP	105 105 0900	
				WP-005	SPL	105 105 0450	
				WP-017	SPP	105 105 0500	
WP-708	STL	105 105 2850					
WP-708	STP	105 105 2850					
0087T							
0013T							
AUDI 100							
Limousine, Avant Nr 44-J-200100>44-K-150000 bez ABS without ABS без ABS *67	ZWP-5132	01.88>07.89	0086P	WP-001	ZPL	105 105 0300	
				WP-001	ZPP	105 105 0300	
				WP-028	PL	105 105 0550	
				WP-047	PP	105 105 1500	
				WP-017	TL	105 105 0500	
				WP-559	TP	105 105 2350	
				WP-018	ZTL	105 105 0650	
				WP-018	ZTP	105 105 0650	
				WP-029	CC	105 105 3200	
				WP-040	CC+	105 105 3300	
0087T							
0013T							

MARKA SAMOCHODU
CAR MODEL
МОДЕЛЬ АВТОМБИЯ

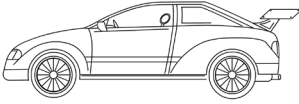

NUMER ZESTAWU
SET NUMBER
НОМЕР НАБОРА

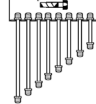

ROK PRODUKCJI
PRODUCTION YEAR
ГОД ВЫПУСКА АВТОМБИЯ



ODPOWIETRZNIK
BLEEDER SCREW
ШТУЦЕР ПРОКАЧКИ ТОРМОЗОВ

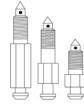

INDEKS
INDEX
ИНДЕКС



POŁOŻENIE
LOCATION
МЕСТО

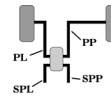

OPIS
DESCRIPTION
ОПИСАНИЕ

ZŁĄCZKA ZŁĄCZKA DŁUGOŚĆ
FITTING FITTING LENGTH
НАКОНЕЧНИК НАКОНЕЧНИК ДЛИНА

AUDI 100											
Limousine, Avant Nr 44-J-200100>44-K-150000 z ABS with ABS c ABS *67	ZWP-5133	01.88>07.89	0086P	WP-001	ZPL	105 105 0300					
				WP-001	ZPP	105 105 0300					
				WP-017	PL	105 105 0500					
				WP-435	PP	105 105 1600					
				WP-017	TL	105 105 0500					
				WP-559	TP	105 105 2350					
				WP-018	ZTL	105 105 0650					
				WP-018	ZTP	105 105 0650					
				WP-005	SPL	105 105 0450					
				WP-017	SPP	105 105 0500					
				WP-708	STL	105 105 2850					
				0087T	0013T	WP-708	STP	105 105 2850			
				AUDI 100							
				Limousine, Avant Nr 44-L-000001>44-M-050000 bez ABS without ABS без ABS *66	ZWP-5134	08.89>11.90	0086P	WP-001	ZPL	105 105 0300	
WP-001	ZPP	105 105 0300									
WP-028	PL	105 105 0550									
WP-039	PP	105 105 1550									
WP-005	TL	105 105 0450									
WP-706	TP	105 105 2450									
WP-002	ZTL	105 105 0850									
WP-002	ZTP	105 105 0850									
WP-016	CL	105 105 2900									
0087T	0013T	WP-708	CP					105 105 2850			
AUDI 100											
Limousine, Avant Nr 44-L-000001>44-M-050000 z ABS with ABS c ABS *66	ZWP-5135	08.89>11.90	0086P					WP-001	ZPL	105 105 0300	
								WP-001	ZPP	105 105 0300	
								WP-045	PL	105 105 0400	
				WP-039	PP	105 105 1550					
				WP-005	TL	105 105 0450					
				WP-706	TP	105 105 2450					
				WP-002	ZTL	105 105 0850					
				WP-002	ZTP	105 105 0850					
				WP-005	SPL	105 105 0450					
				WP-017	SPP	105 105 0500					
				WP-708	STL	105 105 2850					
				0087T	0013T	WP-016	STP	105 105 2900			
				AUDI 100							
				Limousine, Avant Nr 44-L-000001>44-M-050000 bez ABS without ABS без ABS *67	ZWP-5136	08.89>11.90	0086P	WP-001	ZPL	105 105 0300	
WP-001	ZPP	105 105 0300									
WP-028	PL	105 105 0550									
WP-039	PP	105 105 1550									
WP-005	TL	105 105 0450									
WP-706	TP	105 105 2450									
WP-009	ZTL	105 105 0600									
WP-009	ZTP	105 105 0600									
WP-005	SPL	105 105 0450									
WP-017	SPP	105 105 0500									
WP-708	STL	105 105 2850									
0087T	0013T	WP-016	CC+					105 105 2900			
AUDI 100											
Limousine, Avant Nr 44-L-000001>44-M-050000 z ABS with ABS c ABS *67	ZWP-5137	08.89>11.90	0086P					WP-001	ZPL	105 105 0300	
				WP-001	ZPP	105 105 0300					
				WP-045	PL	105 105 0400					
				WP-039	PP	105 105 1550					
				WP-005	TL	105 105 0450					
				WP-706	TP	105 105 2450					
				WP-009	ZTL	105 105 0600					
				WP-009	ZTP	105 105 0600					
				WP-005	SPL	105 105 0450					
				WP-017	SPP	105 105 0500					
				WP-708	STL	105 105 2850					
				0087T	0013T	WP-016	STP	105 105 2900			
				AUDI 100							
				Limousine, Avant Nr 4A-M-000001>4A-N-250000 bez ABS without ABS без ABS *66	ZWP-5138	12.90>06.92	0086P	WP-001	ZPL	105 105 0300	
WP-001	ZPP	105 105 0300									
WP-028	PL	105 105 0550									
WP-003	PP	105 105 1400									
WP-005	TL	105 105 0450									
WP-559	TP	105 105 2350									
WP-013	ZTL	105 105 0900									
WP-013	ZTP	105 105 0900									
WP-013	SPL	105 105 0900									
WP-019	SPP	105 105 1000									
WP-706	STL	105 105 2450									
0087T	0033T	WP-706	STP					105 105 2450			

MARKA SAMOCHODU
CAR MODEL
МОДЕЛЬ АВТОМБИЯ

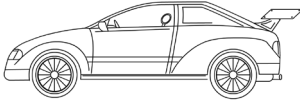

NUMER ZESTAWU
SET NUMBER
НОМЕР НАБОРА

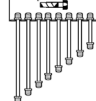

ROK PRODUKCJI
PRODUCTION YEAR
ГОД ВЫПУСКА АВТОМБИЯ



ODPOWIETRZNIK
BLEEDER SCREW
ШТУЦЕР ПРОКАЧКИ ТОРМОЗОВ

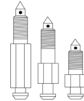

INDEKS
INDEX
ИНДЕКС



POŁOŻENIE
LOCATION
МЕСТО

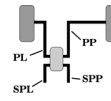

OPIS
DESCRIPTION
ОПИСАНИЕ

ZŁĄCZKA ZŁĄCZKA DŁUGOŚĆ
FITTING FITTING LENGTH
НАКОНЕЧНИК НАКОНЕЧНИК ДЛИНА

AUDI 100											
Limousine, Avant Nr 4A-M-000001>4A-N-250000 z ABS with ABS c ABS *66	ZWP-5139	12.90>06.92	0086P	WP-001	ZPL	105 105 0300					
				WP-001	ZPP	105 105 0300					
				WP-009	PL	105 105 0600					
				WP-049	PP	105 105 1900					
				WP-005	TL	105 105 0450					
				WP-559	TP	105 105 2350					
				WP-013	ZTL	105 105 0900					
				WP-013	ZTP	105 105 0900					
				WP-117	SPL	105 105 0750					
				WP-024	SPP	105 105 0800					
				WP-708	STL	105 105 2850					
				0087T	WP-708	STP	105 105 2850				
				0033T	WP-708	STP	105 105 2850				
				AUDI 100							
Limousine, Avant Nr 4A-M-000001>4A-N-250000 bez ABS without ABS без ABS *67	ZWP-5140	12.90>06.92	0086P	WP-001	ZPL	105 105 0300					
				WP-001	ZPP	105 105 0300					
				WP-028	PL	105 105 0550					
				WP-003	PP	105 105 1400					
				WP-005	TL	105 105 0450					
				WP-559	TP	105 105 2350					
				WP-009	ZTL	105 105 0600					
				WP-009	ZTP	105 105 0600					
				WP-013	SPL	105 105 0900					
				WP-019	SPP	105 105 1000					
				WP-706	STL	105 105 2450					
				0087T	WP-706	STP	105 105 2450				
				0033T	WP-706	STP	105 105 2450				
				AUDI 100							
Limousine, Avant Nr 4M-000001>4A-N-250000 z ABS with ABS c ABS *67	ZWP-5141	12.90>06.92	0086P	WP-001	ZPL	105 105 0300					
				WP-001	ZPP	105 105 0300					
				WP-009	PL	105 105 0600					
				WP-049	PP	105 105 1900					
				WP-005	TL	105 105 0450					
				WP-559	TP	105 105 2350					
				WP-009	ZTL	105 105 0600					
				WP-009	ZTP	105 105 0600					
				WP-117	SPL	105 105 0750					
				WP-024	SPP	105 105 0800					
				WP-708	STL	105 105 2850					
				0087T	WP-708	STP	105 105 2850				
				0033T	WP-708	STP	105 105 2850				
				AUDI 200							
Nr 43-A-045129>44-M-050000	ZWP-5142	80>83	0087P	WP-028	PL	105 105 0550					
				WP-003	PP	105 105 1400					
				WP-005	TL	105 105 0450					
				WP-012	TP	105 105 1650					
				WP-041	ZTL	105 105 0350					
				WP-005	ZTP	105 105 0450					
				WP-045	CL	105 105 3400					
				0087T	WP-021	CP	105 105 3600				
				AUDI 200							
				Nr 43-A-045129>44-G-073362	ZWP-5143	84>86	0087P	WP-028	PL	105 105 0550	
WP-003	PP	105 105 1400									
WP-033	TL	105 105 0700									
WP-012	TP	105 105 1650									
WP-029	CL	105 105 3200									
0087T	WP-040	CP	105 105 3300								
AUDI 200											
Nr 44-G-073363>44-M-050000	ZWP-5144	86>	0087P	WP-028	PL	105 105 0550					
				WP-003	PP	105 105 1400					
				WP-017	TL	105 105 0500					
				WP-011	TP	105 105 2300					
				WP-018	ZTL	105 105 0650					
				WP-018	ZTP	105 105 0650					
				WP-029	CL	105 105 3200					
				0087T	WP-040	CP	105 105 3300				
				AUDI 200							
Avant, Quattro, Turbo Nr 44-F-000001>44-G-073362	ZWP-5145	85>86	0087P	WP-005	ZPL	105 105 0450					
				WP-042	ZPP	105 105 1700					
				WP-041	PL	105 105 0350					
				WP-041	PP	105 105 0350					
				WP-027	TL	105 105 1250					
				WP-006	TP	105 105 0250					
				WP-035	ZTL	105 105 1100					
				WP-009	ZTP	105 105 0600					
				0087T	WP-017	CL	105 105 0500				
				0087T	WP-167	CP	105 105 2600				

MARKA SAMOCHODU
CAR MODEL
МОДЕЛЬ АВТОМБИЯ

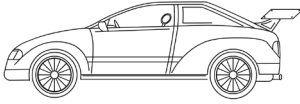

NUMER ZESTAWU
SET NUMBER
НОМЕР НАБОРА

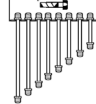

ROK PRODUKCJI
PRODUCTION YEAR
ГОД ВЫПУСКА АВТОМБИЯ



ODPOWIETRZNIK
BLEEDER SCREW
ШТУЦЕР ПРОКАЧКИ ТОРМОЗОВ

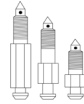

INDEKS
INDEX
ИНДЕКС



POŁOŻENIE
LOCATION
МЕСТО

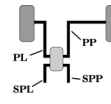

OPIS
DESCRIPTION
ОПИСАНИЕ

ZŁĄCZKA FITTING НАКОНЕЧНИК
ZŁĄCZKA FITTING НАКОНЕЧНИК
DŁUGOŚĆ LENGTH ДЛИНА

MARKA SAMOCHODU CAR MODEL МОДЕЛЬ АВТОМБИЯ	NUMER ZESTAWU SET NUMBER НОМЕР НАБОРА	ROK PRODUKCJI PRODUCTION YEAR ГОД ВЫПУСКА АВТОМБИЯ	ODPOWIETRZNIK BLEEDER SCREW ШТУЦЕР ПРОКАЧКИ ТОРМОЗОВ	INDEKS INDEX ИНДЕКС	POŁOŻENIE LOCATION МЕСТО	OPIS DESCRIPTION ОПИСАНИЕ				
AUDI 200										
Avant, Quatro, Turbo Nr 44-G-073363>44-M-050000	ZWP-5146	86>91	0087P	WP-005	ZPL	105 105 0450				
				WP-042	ZPP	105 105 1700				
				WP-041	PL	105 105 0350				
				WP-041	PP	105 105 0350				
				WP-013	TL	105 105 0900				
				WP-006	TP	105 105 0250				
				WP-035	ZTL	105 105 1100				
				WP-009	ZTP	105 105 0600				
				WP-017	CL	105 105 0500				
				0087T	WP-167	CP	105 105 2600			
AUDI A3										
Wszystkie modele z ABS All models with ABS Все модели с ABS	ZWP-5153	09.96>04.03	0015P	WP-499	PL	104 105 0650				
				WP-196	PP	105 105 1300				
					TL	N/A				
					TP	N/A				
				WP-043	KOR	105 105 0200				
				WP-196	KOR	105 105 1300				
				WP-533	CL	104 105 2750				
				*67	WP-030	CP	105 105 3700			
				AUDI A3						
				Wszystkie modele z ABS All models with ABS Все модели с ABS	ZWP-5147	09.96>04.03	0015P	WP-499	PL	104 105 0650
WP-196	PP	105 105 1300								
WP-024	TL	105 105 0800								
WP-002	TP	105 105 0850								
WP-043	KOR	105 105 0200								
WP-196	KOR	105 105 1300								
WP-533	CL	104 105 2750								
*66	WP-030	CP	105 105 3700							
AUDI A3										
	ZWP-5154	05.03>	0015P 0019P					WP-497	PL	104 105 1450
				WP-045	PP	105 105 0400				
				WP-487	TL	104 105 0200				
				WP-047	TP	105 105 1500				
				WP-592	CL	104 105 3850				
				0015T	WP-1873	CP	105 110X 3650			
				AUDI A4						
				Wszystkie modele, Nr 8D-5-000001>8D-T-300000 All models, no.8D-5-000001>8D-T-300000 Все модели, нет.8D-5-000001>8D-T-300000	ZWP-5148	11.94>06.96	0015P 0086P	WP-006	ZPL	105 105 0250
								WP-006	ZPP	105 105 0250
								WP-024	PL	105 105 0800
WP-042	PP	105 105 1700								
WP-028	TL	105 105 0550								
WP-028	TP	105 105 0550								
WP-309	POM-ABS	104 105 0700								
WP-309	POM-ABS	104 105 0700								
WP-013	SPL	105 105 0900								
WP-102	SPP	105 106 0800								
WP-717	STL	105 106 2350								
0087T	WP-029	STP	105 105 3200							
AUDI A4										
Wszystkie modele z ABS, bez EDS All models with ABS, without EDS Все модели с ABS, без EDS	ZWP-5149	07.96>04.01	0015P 0086P					WP-006	ZPL	105 105 0250
								WP-006	ZPP	105 105 0250
				WP-013	PL	105 105 0900				
				WP-049	PP	105 105 1900				
				WP-028	TL	105 105 0550				
				WP-028	TP	105 105 0550				
				WP-265	SPL	105 105 0950				
				WP-102	SPP	105 106 0800				
				0087T	WP-717	STL	105 106 2350			
				0087T	WP-029	STP	105 105 3200			
AUDI A6										
Wszystkie modele z ABS, EDS, ASR, Nr 4A-5-000001>4A-V-030000 All models with ABS, EDS, ASR, no.4A-5-000001>4A-V-030000 Все модели с ABS, EDS, ASR, нет.4A-5-000001>4A-V-030000	ZWP-5150	06.94>10.96	0015P	WP-006	ZPL	105 105 0250				
				WP-006	ZPP	105 105 0250				
				WP-309	PL	104 105 0700				
				WP-315	PP	104 105 1950				
				WP-009	TL	105 105 0600				
				WP-009	TP	105 105 0600				
				WP-533	KOR	105 105 2750				
				WP-390	KOR	105 105 2250				
				WP-261	POM-ABS	104 105 0600				
				WP-283	POM-ABS	104 105 0550				
				WP-034	SPL	105 105 1200				
				WP-115	SPP	105 105 1150				
				0087T	WP-390	STL	105 105 2250			
				0087T	WP-049	STP	105 105 1900			

MARKA SAMOCHODU
CAR MODEL
МОДЕЛЬ АВТОМБИЯ

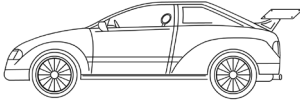

NUMER ZESTAWU
SET NUMBER
НОМЕР НАБОРА

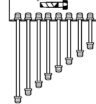

ROK PRODUKCJI
PRODUCTION YEAR
ГОД ВЫПУСКА АВТОМБИЯ



ODPOWIETRZNIK
BLEEDER SCREW
ШТУЦЕР ПРОКАЧКИ ТОРМОЗОВ

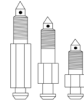

INDEKS
INDEX
ИНДЕКС



POŁOŻENIE
LOCATION
МЕСТО

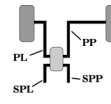

OPIS
DESCRIPTION
ОПИСАНИЕ

ZŁĄCZKA ZŁĄCZKA DŁUGOŚĆ
FITTING FITTING LENGTH
НАКОНЕЧНИК НАКОНЕЧНИК ДЛИНА

MARKA SAMOCHODU CAR MODEL МОДЕЛЬ АВТОМБИЯ	NUMER ZESTAWU SET NUMBER НОМЕР НАБОРА	ROK PRODUKCJI PRODUCTION YEAR ГОД ВЫПУСКА АВТОМБИЯ	ODPOWIETRZNIK BLEEDER SCREW ШТУЦЕР ПРОКАЧКИ ТОРМОЗОВ	INDEKS INDEX ИНДЕКС	POŁOŻENIE LOCATION МЕСТО	OPIS DESCRIPTION ОПИСАНИЕ				
AUDI A6										
Wszystkie modele z ABS, EDS, ASR, Nr 4A-V-030001>4A-V-063389 All models with ABS, EDS, ASR, no.4A-V-030001>4A-V-063389 Все модели с ABS, EDS, ASR, нет.4A-V-030001>4A-V-063389	ZWP-5151	11.96>04.97	0015P	WP-006	ZPL	105 105 0250				
				WP-006	ZPP	105 105 0250				
				WP-309	PL	104 105 0700				
				WP-315	PP	104 105 1950				
				WP-001	TL	105 105 0300				
				WP-001	TP	105 105 0300				
				WP-390	KOR	105 105 2250				
				WP-032	KOR	105 105 2800				
				WP-261	POM-ABS	104 105 0600				
				WP-283	POM-ABS	104 105 0550				
				WP-034	SPL	105 105 1200				
				WP-115	SPP	105 105 1150				
				WP-390	STL	105 105 2250				
				WP-049	STP	105 105 1900				
					0087T					
AUDI A6										
Wszystkie modele All models Все модели	ZWP-5152	05.97-01	0015P	WP-001	ZPL	105 105 0300				
				WP-001	ZPP	105 105 0300				
				WP-002	PL	105 105 0850				
				WP-049	PP	105 105 1900				
					TL	N/A				
					TP	N/A				
				WP-013	CPL	105 105 0900				
				WP-448	CPP	105 106 0850				
				WP-1672	CTL	105 106 2450				
				WP-040	CTP	105 105 3300				
	0039T									
AUTOBIANCHI										
Wszystkie modele All models Все модели		>80	0100P	WP-051	PL	112 112 0550				
				WP-052	PP	112 112 1050				
				WP-053	TL	112 112 0500				
				WP-054	TP	112 112 0900				
				WP-055	SP	112 112 2100				
				WP-229	ST	112 112 0250				
	0100T									
Bedford Van										
CF 250		75>84		WP-298	ZPL	109 109 0300				
				WP-298	ZPP	109 109 0300				
				WP-178	PL	109 110 0350				
				WP-178	PL	109 110 0350				
				WP-773	PP	109 110 2600				
				WP-057	TL	109 109 1100				
				WP-407	TP	109 109 0500				
				WP-064	ZTL	109 110 0200				
				WP-064	ZTP	109 110 0200				
				WP-330	SP	109 109 1900				
				WP-297	ST	109 109 2100				
				Bedford Van						
CF 1100		67>77		WP-061	ZPL	109 110 0300				
				WP-061	ZPP	109 110 0300				
				WP-061	PL	109 110 0300				
				WP-771	PP	109 110 2050				
				WP-075	TL	109 109 1700				
				WP-095	TP	109 110 0600				
				WP-298	ZTL	109 109 0300				
				WP-298	ZTP	109 109 0300				
				WP-766	CC	109 109 2550				
				WP-767	CC+	109 109 2650				
				BMW 300 / E21						
316, 318, 320/4, 320/6, 320i	ZWP-5201	06.75>09.82	0086P	WP-045	ZPL	105 105 0400				
				WP-045	ZPP	105 105 0400				
				WP-045	PL	105 105 0400				
				WP-012	PP	105 105 1650				
				WP-017	TL	105 105 0500				
				WP-009	TP	105 105 0600				
				WP-117	TP+	105 105 0750				
				WP-001	SP	105 105 0300				
				WP-004	ST	105 105 3100				
					0033T					
BMW 300 / E30										
316, 318i, 320i bez ABS without ABS без ABS	ZWP-5202	10.82>11.90	0087P	WP-001	PL	105 105 0300				
				WP-039	PP	105 105 1550				
				WP-001	TL	105 105 0300				
				WP-045	TP	105 105 0400				
				WP-009	ZTL	105 105 0600				
				WP-009	ZTP	105 105 0600				
				WP-046	SP	105 105 3500				
				WP-004	ST	105 105 3100				
	0087T									

MARKA SAMOCHODU
CAR MODEL
МОДЕЛЬ АВТОМБИЯ

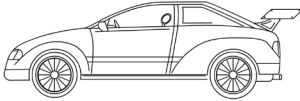

NUMER ZESTAWU
SET NUMBER
НОМЕР НАБОРА

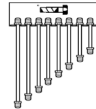

ROK PRODUKCJI
PRODUCTION YEAR
ГОД ВЫПУСКА АВТОМБИЯ



ODPOWIETRZNIK
BLEEDER SCREW
ШТУЦЕР ПРОКАЧКИ ТОРМОЗОВ

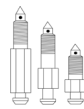

INDEKS
INDEX
ИНДЕКС



POŁOŻENIE
LOCATION
МЕСТО

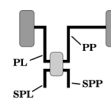

OPIS
DESCRIPTION
ОПИСАНИЕ

ZŁĄCZKA ZŁĄCZKA DŁUGOŚĆ
FITTING FITTING LENGTH
НАКОНЕЧНИК НАКОНЕЧНИК ДЛИНА

MARKA SAMOCHODU CAR MODEL МОДЕЛЬ АВТОМБИЯ	NUMER ZESTAWU SET NUMBER НОМЕР НАБОРА	ROK PRODUKCJI PRODUCTION YEAR ГОД ВЫПУСКА АВТОМБИЯ	ODPOWIETRZNIK BLEEDER SCREW ШТУЦЕР ПРОКАЧКИ ТОРМОЗОВ	INDEKS INDEX ИНДЕКС	POŁOŻENIE LOCATION МЕСТО	OPIS DESCRIPTION ОПИСАНИЕ
BMW 300 / E30						
320i z ABS with ABS с ABS	ZWP-5203	10.82>11.90	0087P	WP-045	PL	105 105 0400
				WP-012	PP	105 105 1650
				WP-001	TL	105 105 0300
				WP-045	TP	105 105 0400
				WP-009	ZTL	105 105 0600
				WP-009	ZTP	105 105 0600
				WP-046	SP	105 105 3500
				WP-004	ST	105 105 3100
				0087T		
BMW 300 / E30						
323i, 324d, TD bez ABS without ABS без ABS	ZWP-5204	09.82>11.90	0087P	WP-045	PL	105 105 0400
				WP-012	PP	105 105 1650
				WP-001	TL	105 105 0300
				WP-045	TP	105 105 0400
				WP-024	ZTL	105 105 0800
				WP-024	ZTP	105 105 0800
				WP-046	SP	105 105 3500
				WP-004	ST	105 105 3100
				0086T		
BMW 300 / E30						
323i z ABS with ABS с ABS	ZWP-5205	09.82>11.90	0087P	WP-002	PL	105 105 0850
				WP-036	PP	105 105 2100
				WP-001	TL	105 105 0300
				WP-045	TP	105 105 0400
				WP-024	ZTL	105 105 0800
				WP-024	ZTP	105 105 0800
				WP-046	SP	105 105 3500
				WP-004	ST	105 105 3100
				0086T		
BMW 300 / E30						
316i, 318i 4-drzwi bez ABS 4-doors without ABS 4-двери без ABS	ZWP-5206	12.90>98	0086P	WP-019	PL	105 105 1000
				WP-036	PP	105 105 2100
				WP-115	TL	105 105 1150
				WP-042	TP	105 105 1700
				WP-006	ZTL	105 105 0250
				WP-006	ZTP	105 105 0250
				WP-559	CC	105 105 2350
0086T						
BMW 300 / E30						
316i, 318i 4-drzwi z ABS 4-doors with ABS 4-двери с ABS	ZWP-5207	12.90>98	0086P	WP-019	PL	105 105 1000
				WP-440	PP	105 105 2150
				WP-115	TL	105 105 1150
				WP-042	TP	105 105 1700
				WP-043	ZTL	105 105 0200
				WP-043	ZTP	105 105 0200
				WP-428	CC	105 105 2050
0086T						
BMW 300 / E36						
316i Coupe z ABS with ABS с ABS	ZWP-5209	03.93>98	0086P	WP-019	PL	105 105 1000
				WP-440	PP	105 105 2150
				WP-115	TL	105 105 1150
				WP-042	TP	105 105 1700
				WP-006	ZTL	105 105 0250
				WP-006	ZTP	105 105 0250
				WP-428	CC	105 105 2050
0086T						
BMW 300 / E36						
318i Coupe z ABS with ABS с ABS	ZWP-5207	01.92>98	0086P	WP-019	PL	105 105 1000
				WP-440	PP	105 105 2150
				WP-115	TL	105 105 1150
				WP-042	TP	105 105 1700
				WP-043	ZTL	105 105 0200
				WP-043	ZTP	105 105 0200
				WP-428	CC	105 105 2050
0053T						
BMW 300 / E36						
320i 4-drzwi bez ABS 4-doors without ABS 4-двери без ABS	ZWP-5208	01.90>98	0086P	WP-019	PL	105 105 1000
				WP-036	PP	105 105 2100
				WP-115	TL	105 105 1150
				WP-042	TP	105 105 1700
				WP-043	ZTL	105 105 0200
				WP-043	ZTP	105 105 0200
				WP-559	CC	105 105 2350
0053T						
BMW 300 / E36						
320i 4-drzwi z ABS 4-doors with ABS 4-двери с ABS	ZWP-5207	01.90>98	0086P	WP-019	PL	105 105 1000
				WP-440	PP	105 105 2150
				WP-115	TL	105 105 1150
				WP-042	TP	105 105 1700
				WP-043	ZTL	105 105 0200
				WP-043	ZTP	105 105 0200
				WP-428	CC	105 105 2050
0053T						

MARKA SAMOCHODU
CAR MODEL
МОДЕЛЬ АВТОМБИЯ

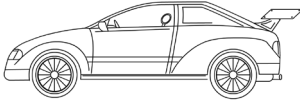

NUMER ZESTAWU
SET NUMBER
НОМЕР НАБОРА

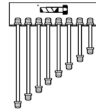

ROK PRODUKCJI
PRODUCTION YEAR
ГОД ВЫПУСКА АВТОМБИЯ



ODPOWIETRZNIK
BLEEDER SCREW
ШТУЦЕР ПРОКАЧКИ ТОРМОЗОВ

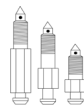

INDEKS
INDEX
ИНДЕКС



POŁOŻENIE
LOCATION
МЕСТО

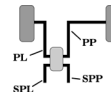

OPIS
DESCRIPTION
ОПИСАНИЕ

ZŁĄCZKA
FITTING
НАКОНЕЧНИК

ZŁĄCZKA
FITTING
НАКОНЕЧНИК

DŁUGOŚĆ
LENGTH
ДЛИНА

MARKA SAMOCHODU CAR MODEL МОДЕЛЬ АВТОМБИЯ	NUMER ZESTAWU SET NUMBER НОМЕР НАБОРА	ROK PRODUKCJI PRODUCTION YEAR ГОД ВЫПУСКА АВТОМБИЯ	ODPOWIETRZNIK BLEEDER SCREW ШТУЦЕР ПРОКАЧКИ ТОРМОЗОВ	INDEKS INDEX ИНДЕКС	POŁOŻENIE LOCATION МЕСТО	OPIS DESCRIPTION ОПИСАНИЕ				
BMW 300 / E36										
320i Coupe z ABS with ABS с ABS	ZWP-5207	01.92>98	0086P	WP-019	PL	105 105 1000				
				WP-440	PP	105 105 2150				
				WP-115	TL	105 105 1150				
				WP-042	TP	105 105 1700				
				WP-043	ZTL	105 105 0200				
				WP-043	ZTP	105 105 0200				
				WP-428	CC	105 105 2050				
BMW 300 / E36										
325i 4-drzwi z ABS, bez ASC+T 4-doors with ABS, without ASC+T 4-двери с ABS, без ASC+T	ZWP-5207	11.89>98	0086P	WP-019	PL	105 105 1000				
				WP-440	PP	105 105 2150				
				WP-115	TL	105 105 1150				
				WP-042	TP	105 105 1700				
				WP-043	ZTL	105 105 0200				
				WP-043	ZTP	105 105 0200				
				WP-428	CC	105 105 2050				
BMW 300 / E36										
325i Coupe z ABS, bez ASC+T with ABS, without ASC+T с ABS, без ASC+T	ZWP-5207	10.90>98	0086P	WP-019	PL	105 105 1000				
				WP-440	PP	105 105 2150				
				WP-115	TL	105 105 1150				
				WP-042	TP	105 105 1700				
				WP-043	ZTL	105 105 0200				
				WP-043	ZTP	105 105 0200				
				WP-428	CC	105 105 2050				
BMW 300 / E36										
325TD 4-drzwi bez ABS 4-doors without ABS 4-двери без ABS	ZWP-5208	01.91>98	0086P	WP-019	PL	105 105 1000				
				WP-036	PP	105 105 2100				
				WP-115	TL	105 105 1150				
				WP-042	TP	105 105 1700				
				WP-043	ZTL	105 105 0200				
				WP-043	ZTP	105 105 0200				
				WP-559	CC	105 105 2350				
BMW 300 / E36										
325TD 4-drzwi z ABS 4-doors with ABS 4-двери с ABS	ZWP-5207	01.91>98	0086P	WP-019	PL	105 105 1000				
				WP-440	PP	105 105 2150				
				WP-115	TL	105 105 1150				
				WP-042	TP	105 105 1700				
				WP-043	ZTL	105 105 0200				
				WP-043	ZTP	105 105 0200				
				WP-428	CC	105 105 2050				
BMW 300 / E36										
325TDS 4-drzwi z ABS 4-doors with ABS 4-двери с ABS	ZWP-5207	01.91>98	0086P	WP-019	PL	105 105 1000				
				WP-440	PP	105 105 2150				
				WP-115	TL	105 105 1150				
				WP-042	TP	105 105 1700				
				WP-043	ZTL	105 105 0200				
				WP-043	ZTP	105 105 0200				
				WP-428	CC	105 105 2050				
BMW 300 / E36										
M3 Coupe z ABS with ABS с ABS	ZWP-5207	03.92>98	0086P	WP-019	PL	105 105 1000				
				WP-440	PP	105 105 2150				
				WP-115	TL	105 105 1150				
				WP-042	TP	105 105 1700				
				WP-043	ZTL	105 105 0200				
				WP-043	ZTP	105 105 0200				
				WP-428	CC	105 105 2050				
BMW 300 / E46										
Wszystkie modele All models Все модели		04.98-		WP-261	PL	104 105 0600				
				WP-390	PP	105 105 2250				
				WP-308	TL	104 105 3700				
				WP-034	TP	105 105 1200				
BMW 500 / E12										
518, 518i, 520i, 520i/4	ZWP-5210	10.74>06.81	0053P	WP-041	ZPL	105 105 0350				
				WP-045	ZPP	105 105 0400				
				WP-001	PL	105 105 0300				
				WP-001	PL	105 105 0300				
				WP-047	PP	105 105 1500				
				WP-039	PP	105 105 1550				
				WP-001	TL	105 105 0300				
				WP-001	TP	105 105 0300				
				WP-009	ZTL	105 105 0600				
				WP-009	ZTP	105 105 0600				
				WP-001	SP	105 105 0300				
				WP-040	ST	105 105 3300				
				BMW 500 / E28						
				518, 518i, 520i, 524TD, 525E bez ABS without ABS без ABS	ZWP-5211	04.81>87	0086P	WP-041	PL	105 105 0350
WP-012	PP	105 105 1650								
WP-009	TL	105 105 0600								
WP-009	TP	105 105 0600								
WP-004	CL	105 105 3100								
WP-040	CP	105 105 3300								

MARKA SAMOCHODU
CAR MODEL
МОДЕЛЬ АВТОМБИЯ

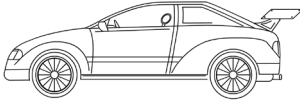

NUMER ZESTAWU
SET NUMBER
НОМЕР НАБОРА

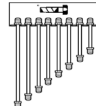

ROK PRODUKCJI
PRODUCTION YEAR
ГОД ВЫПУСКА АВТОМБИЯ



ODPOWIETRZNIK
BLEEDER SCREW
ШТУЦЕР ПРОКАЧКИ ТОРМОЗОВ

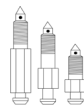

INDEKS
INDEX
ИНДЕКС



POŁOŻENIE
LOCATION
МЕСТО

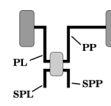

OPIS
DESCRIPTION
ОПИСАНИЕ

ZŁĄCZKA ZŁĄCZKA DŁUGOŚĆ
FITTING FITTING LENGTH
НАКОНЕЧНИК НАКОНЕЧНИК ДЛИНА

MARKA SAMOCHODU CAR MODEL МОДЕЛЬ АВТОМБИЯ	NUMER ZESTAWU SET NUMBER НОМЕР НАБОРА	ROK PRODUKCJI PRODUCTION YEAR ГОД ВЫПУСКА АВТОМБИЯ	ODPOWIETRZNIK BLEEDER SCREW ШТУЦЕР ПРОКАЧКИ ТОРМОЗОВ	INDEKS INDEX ИНДЕКС	POŁOŻENIE LOCATION МЕСТО	OPIS DESCRIPTION ОПИСАНИЕ
BMW 500 / E28						
518,518i, 520i, 524TD, 525E, 525i, 528i z ABS with ABS c ABS	ZWP-5212	04.81>87	0086P	WP-390	PL	105 105 2250
				WP-035	PP	105 105 1100
				WP-028	TL	105 105 0550
				WP-028	TP	105 105 0550
				WP-004	CL	105 105 3100
				WP-040	CP	105 105 3300
528i z ABS with ABS c ABS	ZWP-5212	04.81>87	0086P	WP-390	PL	105 105 2250
				WP-035	PP	105 105 1100
				WP-028	TL	105 105 0550
				WP-028	TP	105 105 0550
				WP-004	CL	105 105 3100
				WP-040	CP	105 105 3300
518i bez ABS without ABS без ABS	ZWP-5214	04.89>08.91	0086P	WP-045	PL	105 105 0400
				WP-042	PP	105 105 1700
				WP-017	ZTL	105 105 0500
				WP-017	ZTP	105 105 0500
				WP-004	CL	105 105 3100
				WP-025	CP	105 105 4300
518i z ABS with ABS c ABS	ZWP-5215	09.91>09.95	0086P	WP-033	PL	105 105 0700
				WP-031	PP	105 105 2200
				WP-001	TL	105 105 0300
				WP-022	TP	105 105 1350
				WP-017	ZTL	105 105 0500
				WP-017	ZTP	105 105 0500
520i bez ABS without ABS без ABS	ZWP-5214	06.87>08.91	0086P	WP-045	PL	105 105 0400
				WP-042	PP	105 105 1700
				WP-017	ZTL	105 105 0500
				WP-017	ZTP	105 105 0500
				WP-004	CL	105 105 3100
				WP-025	CP	105 105 4300
520i z ABS with ABS c ABS	ZWP-5216	03.89>08.91	0086P	WP-018	PL	105 105 0650
				WP-036	PP	105 105 2100
				WP-017	ZTL	105 105 0500
				WP-017	ZTP	105 105 0500
				WP-045	SPL	105 105 0400
				WP-045	SPP	105 105 0400
520i z ABS with ABS c ABS	ZWP-5215	09.91>09.95	0086P	WP-033	PL	105 105 0700
				WP-031	PP	105 105 2200
				WP-001	TL	105 105 0300
				WP-022	TP	105 105 1350
				WP-017	ZTL	105 105 0500
				WP-017	ZTP	105 105 0500
524TD bez ABS without ABS без ABS	ZWP-5214	07.87>09.91	0086P	WP-045	PL	105 105 0400
				WP-042	PP	105 105 1700
				WP-017	ZTL	105 105 0500
				WP-017	ZTP	105 105 0500
				WP-004	CL	105 105 3100
				WP-025	CP	105 105 4300
525i z ABS with ABS c ABS	ZWP-5216	02.90>09.91	0086P	WP-018	PL	105 105 0650
				WP-036	PP	105 105 2100
				WP-017	ZTL	105 105 0500
				WP-017	ZTP	105 105 0500
				WP-045	SPL	105 105 0400
				WP-045	SPP	105 105 0400
525i z ABS, bez ASC+T with ABS, without ASC+T c ABS, без ASC+T	ZWP-5215	09.91>09.95	0086P	WP-033	PL	105 105 0700
				WP-031	PP	105 105 2200
				WP-001	TL	105 105 0300
				WP-022	TP	105 105 1350
				WP-017	ZTL	105 105 0500
				WP-017	ZTP	105 105 0500
525i z ABS, bez ASC+T with ABS, without ASC+T c ABS, без ASC+T	ZWP-5215	09.91>09.95	0086T	WP-534	CC	105 105 3750

MARKA SAMOCHODU
CAR MODEL
МОДЕЛЬ АВТОМБИЯ

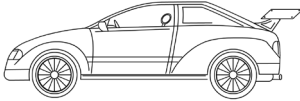

NUMER ZESTAWU
SET NUMBER
НОМЕР НАБОРА

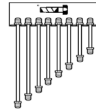

ROK PRODUKCJI
PRODUCTION YEAR
ГОД ВЫПУСКА АВТОМБИЯ



ODPOWIETRZNIK
BLEEDER SCREW
ШТУЦЕР ПРОКАЧКИ ТОРМОЗОВ

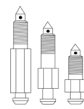

INDEKS
INDEX
ИНДЕКС



POŁOŻENIE
LOCATION
МЕСТО

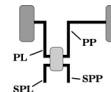

OPIS
DESCRIPTION
ОПИСАНИЕ

ZŁĄCZKA ZŁĄCZKA DŁUGOŚĆ
FITTING FITTING LENGTH
НАКОНЕЧНИК НАКОНЕЧНИК ДЛИНА

MARKA SAMOCHODU CAR MODEL МОДЕЛЬ АВТОМБИЯ	NUMER ZESTAWU SET NUMBER НОМЕР НАБОРА	ROK PRODUKCJI PRODUCTION YEAR ГОД ВЫПУСКА АВТОМБИЯ	ODPOWIETRZNIK BLEEDER SCREW ШТУЦЕР ПРОКАЧКИ ТОРМОЗОВ	INDEKS INDEX ИНДЕКС	POŁOŻENIE LOCATION МЕСТО	OPIS DESCRIPTION ОПИСАНИЕ				
BMW 500 / E34										
525iX z ABS, bez ASC+T with ABS, without ASC+T c ABS, без ASC+T	ZWP-5217	05.91>09.95	0086P	WP-024	PL	105 105 0800				
				WP-390	PP	105 105 2250				
				WP-001	TL	105 105 0300				
				WP-022	TP	105 105 1350				
				WP-017	ZTL	105 105 0500				
				WP-017	ZTP	105 105 0500				
				WP-534	CC	105 105 3750				
BMW 500 / E34										
525TD, 525TDS z ABS with ABS c ABS	ZWP-5215	09.91>09.95	0086P	WP-033	PL	105 105 0700				
				WP-031	PP	105 105 2200				
				WP-001	TL	105 105 0300				
				WP-022	TP	105 105 1350				
				WP-017	ZTL	105 105 0500				
				WP-017	ZTP	105 105 0500				
				WP-534	CC	105 105 3750				
BMW 600 / E24										
628CSi, 635CSi, M635CSi bez ABS without ABS без ABS	ZWP-5218	05.82>89	0086P	WP-045	PL	105 105 0400				
				WP-042	PP	105 105 1700				
				WP-017	ZTL	105 105 0500				
				WP-017	ZTP	105 105 0500				
				WP-004	CL	105 105 3100				
				WP-040	CP	105 105 3300				
				BMW 600 / E24						
628CSi, 635CSi, M635CSi z ABS with ABS c ABS	ZWP-5219	05.82>89	0086P	WP-035	PL	105 105 1100				
				WP-049	PP	105 105 1900				
				WP-017	ZTL	105 105 0500				
				WP-017	ZTP	105 105 0500				
				WP-004	CL	105 105 3100				
				WP-040	CP	105 105 3300				
				BMW 600 / E24						
628CSi, 630CSi, 633CSi, 635CSi, M635CSi z ABS with ABS c ABS	ZWP-5220	>05.82	0053P	WP-041	ZPL	105 105 0350				
				WP-045	ZPP	105 105 0400				
				WP-041	PL	105 105 0350				
				WP-045	PL+	105 105 0400				
				WP-039	PP	105 105 1550				
				WP-012	PP+	105 105 1650				
				WP-043	TL	105 105 0200				
				WP-043	TP	105 105 0200				
				WP-024	ZTL	105 105 0800				
				WP-024	ZTP	105 105 0800				
				WP-040	CC	105 105 3300				
				BMW 700 / E23						
				728, 728i, 730, 732i, 733i, 735i bez ABS without ABS без ABS	ZWP-5221	09.81>86	0053P	WP-017	ZPL	105 105 0500
WP-017	ZPP	105 105 0500								
WP-002	ZTL	105 105 0850								
WP-002	ZTP	105 105 0850								
WP-032	CL	105 105 2800								
WP-030	CP	105 105 3700								
BMW 700 / E23										
728, 728i, 730, 732i, 733i, 735i z ABS with ABS c ABS	ZWP-5222	09.81>86	0053P	WP-017	ZPL	105 105 0500				
				WP-017	ZPP	105 105 0500				
				WP-018	PL	105 105 0650				
				WP-049	PP	105 105 1900				
				WP-002	ZTL	105 105 0850				
				WP-002	ZTP	105 105 0850				
				WP-032	CL	105 105 2800				
				WP-030	CP	105 105 3700				
				BMW 700 / E23						
				728i, 732i, 735i, 745i bez ABS without ABS без ABS	ZWP-5223	09.81>86	0053P	WP-017	ZPL	105 105 0500
WP-017	ZPP	105 105 0500								
WP-018	ZTL	105 105 0650								
WP-018	ZTP	105 105 0650								
WP-032	CL	105 105 2800								
WP-021	CP	105 105 3600								
BMW 700 / E23										
728i, 732i, 735i, 745i z ABS with ABS c ABS	ZWP-5224	09.81>86	0053P	WP-017	ZPL	105 105 0500				
				WP-017	ZPP	105 105 0500				
				WP-018	PL	105 105 0650				
				WP-049	PP	105 105 1900				
				WP-018	ZTL	105 105 0650				
				WP-018	ZTP	105 105 0650				
				WP-032	CL	105 105 2800				
				WP-021	CP	105 105 3600				
				Citroen AX COPPER						
				Wszystkie modele All models Все модели -PR3825 *72 *73	ZWP-5301	09.86>04.87	0015P	WP-013	PL	105 105 0900
WP-022	PP	105 105 1350								
WP-441	TL	104 105 0500								
WP-441	TP	104 105 0500								
WP-029	CL	105 105 3200								
WP-358	CP	105 105 4000								
Citroen AX COPPER										
			0053T							

MARKA SAMOCHODU
CAR MODEL
МОДЕЛЬ АВТОМБИЯ

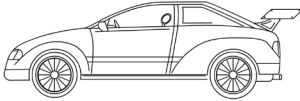

NUMER ZESTAWU
SET NUMBER
НОМЕР НАБОРА

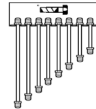

ROK PRODUKCJI
PRODUCTION YEAR
ГОД ВЫПУСКА АВТОМБИЯ



ODPOWIETRNIK
BLEEDER SCREW
ШТУЦЕР ПРОКАЧКИ ТОРМОЗОВ

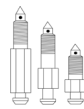

INDEKS
INDEX
ИНДЕКС



POŁOŻENIE
LOCATION
МЕСТО

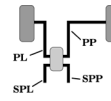

OPIS
DESCRIPTION
ОПИСАНИЕ

ZŁĄCZKA
FITTING
НАКОНЕЧНИК

ZŁĄCZKA
FITTING
НАКОНЕЧНИК

DŁUGOŚĆ
LENGTH
ДЛИНА

MARKA SAMOCHODU CAR MODEL МОДЕЛЬ АВТОМБИЯ	NUMER ZESTAWU SET NUMBER НОМЕР НАБОРА	ROK PRODUKCJI PRODUCTION YEAR ГОД ВЫПУСКА АВТОМБИЯ	ODPOWIETRNIK BLEEDER SCREW ШТУЦЕР ПРОКАЧКИ ТОРМОЗОВ	INDEKS INDEX ИНДЕКС	POŁOŻENIE LOCATION МЕСТО	OPIS DESCRIPTION ОПИСАНИЕ
Citroen AX COPPER						
Wszystkie modele All models Все модели PR3826-PR5277 *72 *74	ZWP-5302	05.87>04.91	0015P	WP-013	PL	105 105 0900
				WP-022	PP	105 105 1350
				WP-019	TL	105 105 1000
				WP-028	TP	105 105 0550
				WP-017	ZTL	105 105 0500
				WP-017	ZTP	105 105 0500
				WP-020	CL	105 105 3400
				WP-020	CP	105 105 3400
				0053T		
				0053T		
Citroen Berlingo						
Wszystkie modele bez ABS do Nr PR8609 All models without ABS, to no. PR8609 Все модели без ABS, к нет. PR8609	ZWP-5303	07.96>04.00	0100P	WP-018	PL	105 105 0650
				WP-039	PP	105 105 1550
				WP-027	TL	105 105 1250
				WP-009	TP	105 105 0600
				WP-005	ZTL	105 105 0450
				WP-005	ZTP	105 105 0450
				WP-007	CL	105 105 3900
				WP-007	CP	105 105 3900
				0069T		
				0069T		
Citroen Berlingo						
Wszystkie modele z ABS do Nr PR8609 All models with ABS, to no. PR8609 Все модели с ABS, к нет. PR8609	ZWP-5304	07.96>04.00	0100P	WP-435	PL	105 105 1600
				WP-034	PP	105 105 1200
				WP-027	TL	105 105 1250
				WP-009	TP	105 105 0600
				WP-005	ZTL	105 105 0450
				WP-005	ZTP	105 105 0450
				WP-034	SPL	105 105 1200
				WP-027	SPP	105 105 1250
				WP-007	CL	105 105 3900
				WP-007	CP	105 105 3900
0069T						
0069T						
Citroen Berlingo						
Wszystkie modele bez ABS od Nr PR8610 All models without ABS, from no. PR8610 Все модели без ABS, от нет. PR8610	ZWP-5305	05.00>	0100P	WP-252	PL	105 105 1050
				WP-042	PP	105 105 1700
				WP-027	TL	105 105 1250
				WP-009	TP	105 105 0600
				WP-005	ZTL	105 105 0450
				WP-005	ZTP	105 105 0450
				WP-572	CL	105 106 3950
				WP-572	CP	105 106 3950
				0069T		
				0069T		
Citroen Berlingo						
Wszystkie modele z ABS od Nr PR8610 All models with ABS, from no. PR8610 Все модели с ABS, от нет. PR8610	ZWP-5306	05.00>	0100P	WP-047	PL	105 105 1500
				WP-034	PP	105 105 1200
				WP-027	TL	105 105 1250
				WP-009	TP	105 105 0600
				WP-005	ZTL	105 105 0450
				WP-005	ZTP	105 105 0450
				WP-019	SPL	105 105 1000
				WP-019	SPP	105 105 1000
				WP-572	CL	105 106 3950
				WP-572	CP	105 106 3950
0069T						
0069T						
Citroen C3						
Wszystkie modele All models Все модели	ZWP-5307	02.02>	0086P	WP-264	PL	104 105 0750
				WP-482	PP	105 105 1950
				WP-028	TL	105 105 0550
				WP-018	TP	105 105 0650
				WP-020	CL	104 105 3400
				WP-030	CP	105 105 3700
				0100T		
Citroen C5						
Wszystkie modele All models Все модели	ZWP-5308	02.01>	0015P	WP-544	PL	104 105 0950
				WP-315	PP	105 105 1950
				WP-018	TL	105 105 0650
				WP-018	TP	105 105 0650
				WP-571	CL	104 105 3850
				WP-050	CP	105 105 4100
0087T						
Citroen Jumper 27-31						
bez ABS without ABS без ABS rozstaw osi 2850 mm wheel base 2850 mm колесная база 2850 мм	ZWP-5309	02.94>04.02	0015P	WP-035	PL	105 105 1100
				WP-115	PL	105 105 1150
				WP-014	PP	105 105 2400
				WP-706	PP	105 105 2450
				WP-435	CL	105 105 1600
				WP-036	CP	105 105 2100
				WP-453	ST	104 105 0250
				WP-018	TL	105 105 0650
				WP-003	TP	105 105 1400
				0069T		
0069T						
Citroen Jumper						
bez ABS without ABS без ABS rozstaw osi 3200 mm wheel base 3200 mm колесная база 3200 мм	ZWP-5310	02.94>04.02	0015P	WP-115	PL	105 105 1150
				WP-034	PL	105 105 1200
				WP-014	PP	105 105 2400
				WP-014	PP	105 105 2400
				WP-012	SP	105 106 1650
				WP-404	ST	105 105 2550
				WP-018	TL	105 105 0650
				WP-003	TP	105 105 1400
				0069T		
0069T						

MARKA SAMOCHODU
CAR MODEL
МОДЕЛЬ АВТОМБИЯ

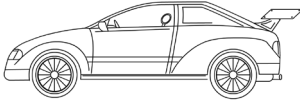

NUMER ZESTAWU
SET NUMBER
НОМЕР НАБОРА

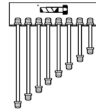

ROK PRODUKCJI
PRODUCTION YEAR
ГОД ВЫПУСКА АВТОМБИЯ



ODPOWIETRZNIK
BLEEDER SCREW
ШТУЦЕР ПРОКАЧКИ ТОРМОЗОВ

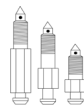

INDEKS
INDEX
ИНДЕКС



POŁOŻENIE
LOCATION
МЕСТО

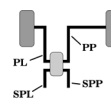

OPIS
DESCRIPTION
ОПИСАНИЕ

ZŁĄCZKA
FITTING
НАКОНЕЧНИК

ZŁĄCZKA
FITTING
НАКОНЕЧНИК

DŁUGOŚĆ
LENGTH
ДЛИНА

MARKA SAMOCHODU CAR MODEL МОДЕЛЬ АВТОМБИЯ	NUMER ZESTAWU SET NUMBER НОМЕР НАБОРА	ROK PRODUKCJI PRODUCTION YEAR ГОД ВЫПУСКА АВТОМБИЯ	ODPOWIETRZNIK BLEEDER SCREW ШТУЦЕР ПРОКАЧКИ ТОРМОЗОВ	INDEKS INDEX ИНДЕКС	POŁOŻENIE LOCATION МЕСТО	OPIS DESCRIPTION ОПИСАНИЕ
Citroen Jumper						
bez ABS without ABS без ABS rozstaw osi 3700 mm wheel base 3700 mm колесная база 3700 мм	ZWP-5311	02.94>04.02	0015P	WP-115	PL	105 105 1150
				WP-034	PL	105 105 1200
				WP-014	PP	105 105 2400
				WP-014	PP	105 105 2400
				WP-012	SP	105 106 1650
				WP-040	ST	105 105 3300
				WP-018	TL	105 105 0650
				WP-003	TP	105 105 1400
Citroen Jumper						
Wszystkie modele z ABS do Nr S15445357 All models with ABS, to no. S15445357 Все модели с ABS, к нет. S15445357	ZWP-5312	02.94>04.02	0015P	WP-115	PL	105 105 1150
				WP-167	PP	105 105 2600
				WP-1667	SPL	104 105 2150
				WP-1684	SPP	105 110X 2150
				WP-043	STL	105 105 0200
				WP-1696	STP	104X 105 0300
				WP-018	TL	105 105 0650
				WP-003	TP	105 105 1400
Citroen Jumper 30						
z ABS, krótki rozstaw osi with ABS, short wheel base с ABS, короткий колесная база	ZWP-5324	04.02>	0039P	WP-019	PL	105 105 1000
				WP-706	PP	105 105 2450
				WP-018	TL	105 105 0650
				WP-528	TP	104X 105 1350
				WP-491	SPL	104 105 1800
				WP-1866	SPP	105 110X 1850
				WP-036	CL	105 105 2100
				WP-1867	CP	105 110X 2200
Citroen Jumper 33						
z ABS, krótki rozstaw osi with ABS, long wheel base с ABS, средний колесная база	ZWP-5325	04.02>	0039P	WP-019	PL	105 105 1000
				WP-706	PP	105 105 2450
				WP-018	TL	105 105 0650
				WP-528	TP	104X 105 1350
				WP-491	SPL	104 105 1800
				WP-1866	SPP	105 110X 1850
				WP-167	CL	105 105 2600
				WP-1869	CP	105 110X 2650
Citroen Jumper 35						
z ABS, długi rozstaw osi with ABS, mid wheel base с ABS, длинная колесная база	ZWP-5326	04.02>	0039P	WP-019	PL	105 105 1000
				WP-706	PP	105 105 2450
				WP-017	TL	105 105 0500
				WP-506	TP	104X 105 1250
				WP-491	SPL	104 105 1800
				WP-1866	SPP	105 110X 1850
				WP-040	CL	105 105 3300
				WP-1871	CP	105 110X 3350
Citroen Jumpy						
1.9, 2.0i 16V, 2.0 HDi krótki model short model короткая модель	ZWP-5327	10.95>	0015P	WP-002	PL	105 105 0850
				WP-013	PP	105 105 0900
				WP-024	TL	105 105 0800
				WP-024	TP	105 105 0800
				WP-506	SPL	104X 105 1250
				WP-027	SPP	105 105 1250
				WP-1728	CL	105 107 2500
				WP-1870	CP	105 110X 3100
Citroen Jumpy						
2.0 Hdi długi model long model длинная модель	ZWP-5328	10.95>	0015P	WP-002	PL	105 105 0850
				WP-013	PP	105 105 0900
				WP-024	TL	105 105 0800
				WP-024	TP	105 105 0800
				WP-506	SPL	104X 105 1250
				WP-027	SPP	105 105 1250
				WP-1728	CL	105 107 2950
				WP-1881	CP	105 110X 3550
Citroen Saxo						
Wszystkie modele All models Все модели	ZWP-5329	05.96>04.04	0053P	WP-261	PL	104 105 0600
				WP-196	PP	105 105 1300
				WP-1741	SPL	104X 110X 0300
				WP-001	SPP	105 105 0300
				WP-004	CL	105 105 3100
				WP-1742	CP	104X 110X 3250
				WP-045	TL	105 105 0400
				WP-532	TP	104X 105 1000
				WP-028	ZTL	105 105 0550
				WP-028	ZTP	105 105 0550
				0053T		

MARKA SAMOCHODU
CAR MODEL
МОДЕЛЬ АВТОМБИЯ

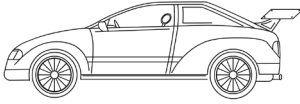

NUMER ZESTAWU
SET NUMBER
НОМЕР НАБОРА

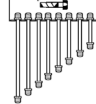

ROK PRODUKCJI
PRODUCTION YEAR
ГОД ВЫПУСКА АВТОМБИЯ



ODPOWIETRZNIK
BLEEDER SCREW
ШТУЦЕР ПРОКАЧКИ ТОРМОЗОВ

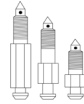

INDEKS
INDEX
ИНДЕКС



POŁOŻENIE
LOCATION
МЕСТО

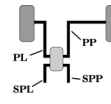

OPIS
DESCRIPTION
ОПИСАНИЕ

ZŁĄCZKA ZŁĄCZKA DŁUGOŚĆ
FITTING FITTING LENGTH
НАКОНЕЧНИК НАКОНЕЧНИК ДЛИНА

MARKA SAMOCHODU CAR MODEL МОДЕЛЬ АВТОМБИЯ	NUMER ZESTAWU SET NUMBER НОМЕР НАБОРА	ROK PRODUKCJI PRODUCTION YEAR ГОД ВЫПУСКА АВТОМБИЯ	ODPOWIETRZNIK BLEEDER SCREW ШТУЦЕР ПРОКАЧКИ ТОРМОЗОВ	INDEKS INDEX ИНДЕКС	POŁOŻENIE LOCATION МЕСТО	OPIS DESCRIPTION ОПИСАНИЕ
Citroen Xsara						
Wszystkie modele z ABS, do Nr OPR08209 All models with ABS, to no. OPR08209 Все модели с ABS, к нет. OPR08209	ZWP-5313	07.97>05.99		WP-019	PL	105 105 1000
				WP-115	PP	105 105 1150
				WP-104	SPL	105 106 1000
				WP-104	SPP	105 106 1000
				WP-708	STL	105 105 2850
				WP-1668	STP	104 105 3400
				WP-024	TL	105 105 0800
				WP-033	TP	105 105 0700
*67, *74						
Citroen Xsara						
Wszystkie modele z ABS All models with ABS Все модели с ABS	ZWP-5314	07.97>11.04		WP-019	PL	105 105 1000
				WP-115	PP	105 105 1150
				WP-104	SPL	105 106 1000
				WP-104	SPP	105 106 1000
				WP-708	STL	105 105 2850
				WP-1668	STP	104 105 3400
				WP-018	TL	105 105 0650
				WP-018	TP	105 105 0650
*66, *74						
Citroen Xsara						
Wszystkie modele z ABS All models with ABS Все модели с ABS	ZWP-5315	07.97>11.04		WP-019	PL	105 105 1000
				WP-115	PP	105 105 1150
				WP-104	SPL	105 106 1000
				WP-104	SPP	105 106 1000
				WP-1627	CC	105 107 1100
				WP-040	STL	105 105 3300
				WP-1668	STP	104 105 3400
				WP-018	TL	105 105 0650
WP-018	TP	105 105 0650				
*66, *72						
Citroen Xsara						
Wszystkie modele z ABS, od Nr OPR08210 All models with ABS, from no. OPR08210 Все модели с ABS, от нет. OPR08210	ZWP-5316	06.99>11.04		WP-019	PL	105 105 1000
				WP-115	PP	105 105 1150
				WP-104	SPL	105 106 1000
				WP-104	SPP	105 106 1000
				WP-1627	CC	105 107 1100
				WP-040	STL	105 105 3300
				WP-1668	STP	104 105 3400
				WP-024	TL	105 105 0800
WP-033	TP	105 105 0700				
*67, *74						
Citroen Xsara Picasso						
Wszystkie modele z ABS, do Nr DAM.10220FV All models with ABS, to no. DAM.10220FV Все модели с ABS, к нет. DAM.10220FV	ZWP-5317	12.99>11.04		WP-017	PL	105 105 0500
				WP-019	PP	105 105 1000
				WP-195	SPL	105 106 0700
				WP-195	SPP	105 106 0700
				WP-007	STL	105 105 3900
				WP-405	STP	104 105 4000
				WP-495	TL	104 105 1300
				WP-045	TP	105 105 0400
				WP-258	ZTL	104 105 0450
				WP-258	ZTP	104 105 0450
*66						
Citroen Visa COPPER						
Wszystkie modele bez Super All models without Super Все модели без Super	ZWP-5318	08.78>88	0039P	WP-024	PL	105 105 0800
				WP-252	PP	105 105 1050
				WP-028	TL	105 105 0550
				WP-028	TP	105 105 0550
			0053T	WP-428	CC	105 105 2050
Citroen Visa COPPER						
Super	ZWP-5319	79>81	0039P	WP-024	PL	105 105 0800
				WP-196	PP	105 105 1300
				WP-017	TL	105 105 0500
				WP-017	TP	105 105 0500
			0053T	WP-014	CC	105 105 2400
Citroen Visa COPPER						
Super	ZWP-5320	82>88	0039P	WP-013	PL	105 105 0900
				WP-042	PP	105 105 1700
				WP-017	TL	105 105 0500
				WP-017	TP	105 105 0500
			0053T	WP-014	CC	105 105 2400
Citroen ZX COPPER						
Wszystkie modele bez 1905cc All models without 1905cc Все модели без 1905cc	ZWP-5321	03.91>12.97	0053P	WP-018	PL	105 105 0650
				WP-039	PP	105 105 1550
				WP-442	TL	105 107 1000
				WP-443	TP	105 107 0550
				WP-261	ZTL	104 105 0600
				WP-261	ZTP	104 105 0600
				WP-310	CC	104 105 2800
	0053T	WP-587	CC+	104 105 2950		

MARKA SAMOCHODU
CAR MODEL
МОДЕЛЬ АВТОМБИЯ

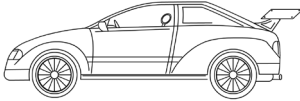

NUMER ZESTAWU
SET NUMBER
НОМЕР НАБОРА

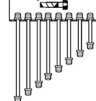

ROK PRODUKCJI
PRODUCTION YEAR
ГОД ВЫПУСКА АВТОМБИЯ



ODPOWIETRZNIK
BLEEDER SCREW
ШТУЦЕР ПРОКАЧКИ ТОРМОЗОВ

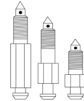

INDEKS
INDEX
ИНДЕКС



POŁOŻENIE
LOCATION
МЕСТО

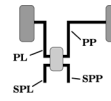

OPIS
DESCRIPTION
ОПИСАНИЕ

ZŁĄCZKA
FITTING
НАКОНЕЧНИК

ZŁĄCZKA
FITTING
НАКОНЕЧНИК

DŁUGOŚĆ
LENGTH
ДЛИНА

MARKA SAMOCHODU CAR MODEL МОДЕЛЬ АВТОМБИЯ	NUMER ZESTAWU SET NUMBER НОМЕР НАБОРА	ROK PRODUKCJI PRODUCTION YEAR ГОД ВЫПУСКА АВТОМБИЯ	ODPOWIETRZNIK BLEEDER SCREW ШТУЦЕР ПРОКАЧКИ ТОРМОЗОВ	INDEKS INDEX ИНДЕКС	POŁOŻENIE LOCATION МЕСТО	OPIS DESCRIPTION ОПИСАНИЕ
Citroen ZX COPPER						
1905cc bez ABS 1905cc without ABS 1905cc без ABS	ZWP-5322	03.91>12.97	0053P	WP-018	PL	105 105 0650
				WP-039	PP	105 105 1550
				WP-017	TL	105 105 0500
				WP-265	TP	105 105 0950
				WP-028	ZTL	105 105 0550
				WP-028	ZTP	105 105 0550
				WP-310	CC	104 105 2800
				WP-587	CC+	104 105 2950
			0053T			
Citroen ZX COPPER						
1905cc z ABS 1905cc with ABS 1905cc с ABS	ZWP-5323	03.91>12.97	0053P	WP-497	PL	104 105 1450
				WP-014	PP	105 105 2400
				WP-017	TL	105 105 0500
				WP-265	TP	105 105 0950
				WP-028	ZTL	105 105 0550
				WP-028	ZTP	105 105 0550
				WP-310	CC	104 105 2800
				WP-587	CC+	104 105 2950
			0053T			
Citroen BX						
Patrz strona / See page / См стр - 135						
Citroen CX						
Patrz strona / See page / См стр - 135						
Citroen CX Kombi						
Patrz strona / See page / См стр - 135						
Citroen 2CV						
Patrz strona / See page / См стр - 135						
Citroen Xantia						
Patrz strona / See page / См стр - 135						
Dacia D1310						
	ZWP-5501	84>92	0053P	WP-731	PL	105 112 0700
				WP-732	PP	105 112 1150
				WP-730	TL	105 112 0600
				WP-538	TP	105 112 1050
				WP-537	CC	105 112 3800
			0053T			
Daewoo Lanos						
Hatchback bez ABS without ABS без ABS	ZWP-5406	97>		WP-265	PL	105 105 0950
				WP-010	PP	105 105 1850
				WP-355	SPL	105 116 1150
				WP-742	SPP	105 116 1200
				WP-1736	STL	116 116 3150
				WP-824	STP	105 116 3350
				WP-346	TM	105 116 0900
				WP-018	ZTL	105 105 0650
				WP-009	ZTP	105 105 0600
Daewoo Matiz						
	ZWP-5401		0017P	WP-735	POM-LACZ P	105 116 0250
				WP-735	POM-LACZ T	105 116 0250
				WP-431	PL	116 116 0650
				WP-809	PP	116 116 1150
				WP-919	CL	116 116 4550
				WP-918	CP	116 116 3750
				WP-578	ZTL	105 116 0300
				WP-578	ZTP	105 116 0300
Daewoo Nexia						
Wszystkie modele bez ABS All models without ABS Все модели без ABS	ZWP-5403	02.95>08.97	0100P 0011P 0011T	WP-441	PL	104 105 0500
				WP-049	PP	105 105 1900
				WP-844	CL	105 110X 3300
				WP-830	CP	104 110X 4000
				WP-018	TL	105 105 0650
				WP-018	TP	105 105 0650
Daewoo Nexia						
Wszystkie modele z ABS All models with ABS Все модели с ABS	ZWP-5404	02.95>08.97	0100P 0011P 0011T	WP-499	PL	104 105 0650
				WP-049	PP	105 105 1900
				WP-829	CL	104 110X 3550
				WP-845	CP	105 110X 3900
				WP-018	TL	105 105 0650
				WP-018	TP	105 105 0650
Daewoo Nubira						
Wszystkie modele bez ABS All models without ABS Все модели без ABS	ZWP-5405	05.97>	0011T	WP-024	PL	105 105 0800
				WP-047	PP	105 105 1500
				WP-023	CL	105 105 1800
				WP-1677	CP	105 116 2800
				WP-006	TL	105 105 0250
				WP-006	TP	105 105 0250

MARKA SAMOCHODU
CAR MODEL
МОДЕЛЬ АВТОМБИЯ

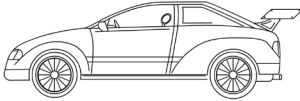

NUMER ZESTAWU
SET NUMBER
НОМЕР НАБОРА

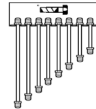

ROK PRODUKCJI
PRODUCTION YEAR
ГОД ВЫПУСКА АВТОМБИЯ



ODPOWIETRZNIK
BLEEDER SCREW
ШТУЦЕР ПРОКАЧКИ ТОРМОЗОВ

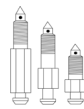

INDEKS
INDEX
ИНДЕКС



POŁOŻENIE
LOCATION
МЕСТО

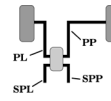

OPIS
DESCRIPTION
ОПИСАНИЕ

ZŁĄCZKA ZŁĄCZKA DŁUGOŚĆ
FITTING FITTING LENGTH
НАКОНЕЧНИК НАКОНЕЧНИК ДЛИНА

MARKA SAMOCHODU CAR MODEL МОДЕЛЬ АВТОМБИЯ	NUMER ZESTAWU SET NUMBER НОМЕР НАБОРА	ROK PRODUKCJI PRODUCTION YEAR ГОД ВЫПУСКА АВТОМБИЯ	ODPOWIETRZNIK BLEEDER SCREW ШТУЦЕР ПРОКАЧКИ ТОРМОЗОВ	INDEKS INDEX ИНДЕКС	POŁOŻENIE LOCATION МЕСТО	OPIS DESCRIPTION ОПИСАНИЕ
Daewoo Nubira						
Wszystkie modele z ABS All models with ABS Все модели с ABS	ZWP-5408	05.97>	0011T	WP-252	PL	105 105 1050
				WP-047	PP	105 105 1500
				WP-023	CL	105 105 1800
				WP-1677	CP	105 116 2800
				WP-006	TL	105 105 0250
				WP-006	TP	105 105 0250
Daewoo Nubira						
Wszystkie modele z ABS All models with ABS Все модели с ABS	ZWP-5409	97>03	0011T	WP-019	PL	105 105 1000
				WP-049	PP	105 105 1900
				WP-015	CL	105 105 2700
				WP-534	CP	105 116 3750
				WP-042	TL	105 105 1700
				WP-041	ZTP	105 105 0350
ŁĄCZNIK / CONNECTOR / ПЕРЕХОДНИК: 5-600-121				WP-041	ZTL	105 105 0350
Daewoo Tico						
	ZWP-5407		0131T	WP-134	PL	116 116 0500
				WP-429	PP	116 116 1000
				WP-118	TL	116 116 0300
				WP-124	TP	116 116 1350
				WP-148	SP	116 116 0800
				WP-125	ST	116 116 0750
				WP-147	CC	116 116 2000
Daihatsu Charade						
G10	ZWP-5602	>83	0017P 0053T	WP-118	ZPL	116 116 0300
				WP-118	ZPP	116 116 0300
				WP-119	PL	116 116 0950
				WP-120	PP	116 116 0550
				WP-123	TL	116 116 0450
				WP-124	TP	116 116 1350
				WP-121	CC	116 116 2800
				WP-122	CC+	116 116 3700
Daihatsu Charade						
G11, G30	ZWP-5603	83>01.87	0086P 0087T	WP-125	PL	116 116 0750
				WP-126	PP	116 116 0900
				WP-118	TL	116 116 0300
				WP-129	TP	116 116 1200
				WP-127	CC	116 116 2600
WP-221	CC+	116 116 3500				
Daihatsu Charade						
G100, G101 bez GTTi, bez Turbo without GTTi, without Turbo без GTTi, без Turbo	ZWP-5604	02.87>10.90	0086P 0087T	WP-134	PL	116 116 0500
				WP-124	PP	116 116 1350
				WP-144	TL	116 116 0400
				WP-144	TP	116 116 0400
				WP-127	CL	116 116 2600
WP-826	CP	116 116 3950				
Daihatsu Charade						
G100, GTTi, Turbo	ZWP-5605	02.87>10.90	0086P 0087T	WP-134	PL	116 116 0500
				WP-124	PP	116 116 1350
				WP-118	TL	116 116 0300
				WP-118	TP	116 116 0300
				WP-819	CL	116 116 2700
WP-826	CP	116 116 3950				
Daihatsu Charade						
G100, G101, G102 bez GTTi, bez Turbo without GTTi, without Turbo без GTTi, без Turbo	ZWP-5606	11.90>92	0086P 0087T	WP-134	PL	116 116 0500
				WP-124	PP	116 116 1350
				WP-144	TL	116 116 0400
				WP-144	TP	116 116 0400
				WP-818	CL	116 116 2550
WP-826	CP	116 116 3950				
Daihatsu Charade						
G100 GTTi, Turbo	ZWP-5607	11.90>92	0086P 0087T	WP-134	PL	116 116 0500
				WP-124	PP	116 116 1350
				WP-118	TL	116 116 0300
				WP-118	TP	116 116 0300
				WP-127	CL	116 116 2600
WP-826	CP	116 116 3950				
Daihatsu Charmant						
A35, A60	ZWP-5608	10.81>07.87	0017P 0086P 0086T	WP-028	PL	105 105 0550
				WP-005	PP	105 105 0450
				WP-035	TL	105 105 1100
				WP-117	TP	105 105 0750
				WP-048	CC	105 105 2500
Fiat 125						
Wszystkie modele All models Все модели	ZWP-5701	69>75	0100P 0100T	WP-410	PL	112 112 1000
				WP-409	PP	112 112 1750
				WP-412	TL	112 112 0600
				WP-052	TP	112 112 1050
				WP-413	CC	112 112 3600
*02 *74				WP-411	KOR-TRÓJ	112 112 0800

MARKA SAMOCHODU
CAR MODEL
МОДЕЛЬ АВТОМБИЯ

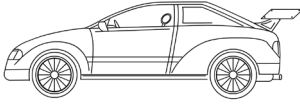

NUMER ZESTAWU
SET NUMBER
НОМЕР НАБОРА

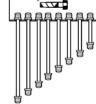

ROK PRODUKCJI
PRODUCTION YEAR
ГОД ВЫПУСКА АВТОМБИЯ



ODPOWIETRZNIK
BLEEDER SCREW
ШТУЦЕР ПРОКАЧКИ ТОРМОЗОВ

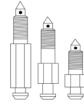

INDEKS
INDEX
ИНДЕКС



POŁOŻENIE
LOCATION
МЕСТО

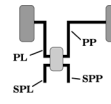

OPIS
DESCRIPTION
ОПИСАНИЕ

ZŁĄCZKA ZŁĄCZKA DŁUGOŚĆ
FITTING FITTING LENGTH
НАКОНЕЧНИК НАКОНЕЧНИК ДЛИНА

MARKA SAMOCHODU CAR MODEL МОДЕЛЬ АВТОМБИЯ	NUMER ZESTAWU SET NUMBER НОМЕР НАБОРА	ROK PRODUKCJI PRODUCTION YEAR ГОД ВЫПУСКА АВТОМБИЯ	ODPOWIETRZNIK BLEEDER SCREW ШТУЦЕР ПРОКАЧКИ ТОРМОЗОВ	INDEKS INDEX ИНДЕКС	POŁOŻENIE LOCATION МЕСТО	OPIS DESCRIPTION ОПИСАНИЕ
Fiat 126						
Wszystkie modele All models Все модели	ZWP-5702	72>86	0100P	WP-153	PL	112 112 0650
				WP-054	PP	112 112 0900
				WP-054	TL	112 112 0900
				WP-229	TP	112 112 0250
				WP-151	ZTL	112 112 0350
				WP-151	ZTP	112 112 0350
				WP-055	CC	112 112 2100
				0100T		
Fiat 127						
Wszystkie modele bez Sport All models without Sport Все модели без Sport	ZWP-5703	78>82	0100P	WP-153	PL	112 112 0650
				WP-160	PP	112 112 1150
				WP-162	TL	112 112 0450
				WP-052	TP	112 112 1050
				WP-470	SP	112 112 2850
				WP-056	ST	112 112 0300
0100T						
Fiat 127						
Sport	ZWP-5704	78>82	0100P	WP-053	PL	112 112 0500
				WP-168	PP	112 112 1600
				WP-162	TL	112 112 0450
				WP-052	TP	112 112 1050
				WP-470	SP	112 112 2850
				WP-056	ST	112 112 0300
0100T						
Fiat 127						
Sedan (Brazylia)	ZWP-5705	83>85	0100P	WP-150	PL	112 112 0400
				WP-152	PP	112 112 1250
				WP-056	TL	112 112 0300
				WP-054	TP	112 112 0900
				WP-157	SP	112 112 3000
				WP-056	ST	112 112 0300
0100T						
Fiat 127						
Panorama (Brazylia)	ZWP-5706	83>86	0100P	WP-053	PL	112 112 0500
				WP-163	PP	112 112 1450
				WP-056	TL	112 112 0300
				WP-054	TP	112 112 0900
				WP-155	SP	112 112 3500
				WP-056	ST	112 112 0300
0100T						
Fiat 128						
C, CL Nr 1966677 -	ZWP-5707	08.77>84	0100P	WP-153	PL	112 112 0650
				WP-163	PP	112 112 1450
				WP-162	TL	112 112 0450
				WP-152	TP	112 112 1250
				WP-161	SP	112 112 2400
				WP-052	ST	112 112 1050
0100T						
Fiat 131						
Wszystkie modele All models Все модели	ZWP-5708	74>83	0100P	WP-151	PL	112 112 0350
				WP-152	PP	112 112 1250
				WP-153	TL	112 112 0650
				WP-052	TP	112 112 1050
				WP-157	SP	112 112 3000
				WP-056	ST	112 112 0300
0100T						
Fiat 132						
Wszystkie modele All models Все модели	ZWP-5709	72>81	0100P	WP-154	PL	112 112 0950
				WP-168	PP	112 112 1600
				WP-053	TL	112 112 0500
				WP-149	TP	112 112 1100
				WP-155	SP	112 112 3500
				WP-153	ST	112 112 0650
0100T						
Fiat 133						
Seat (900 LS)	ZWP-5710	75>80	0100P	WP-153	PL	112 112 0650
				WP-160	PP	112 112 1150
				WP-150	TL	112 112 0400
				WP-150	TP	112 112 0400
				WP-151	ZTL	112 112 0350
				WP-151	ZTP	112 112 0350
				WP-055	CC	112 112 2100
				0100T		
Fiat Argenta						
2.0	ZWP-5711	82>86	0015P	WP-013	PL	105 105 0900
				WP-010	PP	105 105 1850
				WP-028	TL	105 105 0550
				WP-035	TP	105 105 1100
				WP-167	SP	105 105 2600
				WP-018	ST	105 105 0650
0108T						

MARKA SAMOCHODU
CAR MODEL
МОДЕЛЬ АВТОМБИЯ

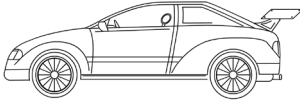

NUMER ZESTAWU
SET NUMBER
НОМЕР НАБОРА

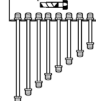

ROK PRODUKCJI
PRODUCTION YEAR
ГОД ВЫПУСКА АВТОМБИЯ



ODPOWIETRZNIK
BLEEDER SCREW
ШТУЦЕР ПРОКАЧКИ ТОРМОЗОВ

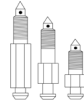

INDEKS
INDEX
ИНДЕКС



POŁOŻENIE
LOCATION
МЕСТО

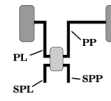

OPIS
DESCRIPTION
ОПИСАНИЕ

ZŁĄCZKA ZŁĄCZKA DŁUGOŚĆ
FITTING FITTING LENGTH
НАКОНЕЧНИК НАКОНЕЧНИК ДЛИНА

MARKA SAMOCHODU CAR MODEL МОДЕЛЬ АВТОМБИЯ	NUMER ZESTAWU SET NUMBER НОМЕР НАБОРА	ROK PRODUKCJI PRODUCTION YEAR ГОД ВЫПУСКА АВТОМБИЯ	ODPOWIETRZNIK BLEEDER SCREW ШТУЦЕР ПРОКАЧКИ ТОРМОЗОВ	INDEKS INDEX ИНДЕКС	POŁOŻENIE LOCATION МЕСТО	OPIS DESCRIPTION ОПИСАНИЕ			
Fiat Bravo									
1.4, 1.6	ZWP-5712	09.95>10.01	0100P	WP-528	PL	104X 105 1350			
				WP-196	PP	105 105 1300			
				WP-018	TL	105 105 0650			
				WP-523	TP	104X 105 1000			
				WP-017	ZTL	105 105 0500			
				WP-017	ZTP	105 105 0500			
				WP-506	SPL	104X 105 1250			
				WP-049	SPP	105 105 1900			
				WP-508	STL	110X 110X 2100			
				0100T	WP-036	STP	105 105 2100		
0053T									
Fiat Bravo									
1.4, 1.6 bez ABS 1.4, 1.6 without ABS 1.4, 1.6 без ABS	ZWP-5713	09.95>10.01	0100P	WP-013	PL	105 105 0900			
				WP-012	PP	105 105 1650			
				WP-017	TL	105 105 0500			
				WP-017	TP	105 105 0500			
				WP-508	SPL	110X 110X 2100			
				WP-036	SPP	105 105 2100			
				WP-009	STL	105 105 0600			
				0100T	WP-511	STP	104X 110X 0600		
0053T									
Fiat Bravo									
1.4, 1.6 z ABS 1.4, 1.6 with ABS 1.4, 1.6 с ABS	ZWP-5712	09.95>10.01	0100P	WP-528	PL	104X 105 1350			
				WP-196	PP	105 105 1300			
				WP-018	TL	105 105 0650			
				WP-523	TP	104X 105 1000			
				WP-017	ZTL	105 105 0500			
				WP-017	ZTP	105 105 0500			
				WP-506	SPL	104X 105 1250			
				WP-049	SPP	105 105 1900			
				WP-508	STL	110X 110X 2100			
				0100T	WP-036	STP	105 105 2100		
0053T									
Fiat Cinquecento									
	ZWP-5714	84>94	0100P	WP-006	PRL	105 105 0250			
				WP-024	PRP	105 105 0800			
				WP-017	ZTL	105 105 0500			
				WP-017	ZTP	105 105 0500			
				WP-833	SPP	104X 105 0950			
				WP-035	SPL	105 105 1100			
				WP-042	PP	105 105 1700			
				WP-014	CL	105 105 2400			
				WP-834	CP	104X 105 2500			
				0100T	WP-024	PL	105 105 0800		
Fiat Cinquecento									
	ZWP-5715	94>	0100P	WP-006	PRL	105 105 0250			
				WP-017	PRP	105 105 0500			
				WP-017	ZTL	105 105 0500			
				WP-017	ZTP	105 105 0500			
				WP-115	SPP	105 105 1150			
				WP-842	SPL	105 110X 1400			
				WP-042	PP	105 105 1700			
				WP-036	CL	105 105 2100			
				WP-843	CP	105 110X 2250			
				0100T	WP-024	PL	105 105 0800		
Fiat Ducato									
bez Maxi, rozstaw osi 2920 mm without Maxi, wheel base 2920 mm без Maxi, колесная база 2920 мм	ZWP-5716	10.81>93	0100P	WP-024	PL	105 105 0800			
				WP-003	PL+	105 105 1400			
				WP-023	PP	105 105 1800			
				WP-011	PP+	105 105 2300			
				WP-024	TL	105 105 0800			
				WP-027	TP	105 105 1250			
				WP-356	SP	105 105 1450			
				0100T	WP-533	ST	105 105 2750		
Fiat Ducato									
Maxi, rozstaw osi 3620 mm Maxi, wheel base 3620 mm Maxi, колесная база 3620 мм	ZWP-5717	10.81>93	0100P	WP-024	PL	105 105 0800			
				WP-003	PL+	105 105 1400			
				WP-023	PP	105 105 1800			
				WP-011	PP+	105 105 2300			
				WP-024	TL	105 105 0800			
				WP-027	TP	105 105 1250			
				WP-356	SP	105 105 1450			
				0100T	WP-710	ST	105 105 3450		
Fiat Ducato									
1000, 1400, 1800 bez ABS, rozstaw osi 2850 mm without ABS, wheel base 2850 mm без ABS, колесная база 2850 мм	ZWP-5718	03.94>03.02	0100P	WP-115	PL	105 105 1150			
				WP-027	PL+	105 105 1250			
				WP-014	PP	105 105 2400			
				WP-706	PP+	105 105 2450			
				WP-117	TL	105 105 0750			
				WP-356	TP	105 105 1450			
				WP-012	SP	105 105 1650			
				0100T	WP-440	ST	105 105 2150		

MARKA SAMOCHODU
CAR MODEL
МОДЕЛЬ АВТОМБИЯ

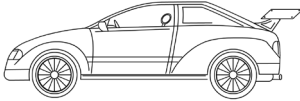

NUMER ZESTAWU
SET NUMBER
НОМЕР НАБОРА

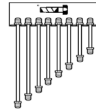

ROK PRODUKCJI
PRODUCTION YEAR
ГОД ВЫПУСКА АВТОМБИЯ



ODPOWIETRZNIK
BLEEDER SCREW
ШТУЦЕР ПРОКАЧКИ ТОРМОЗОВ

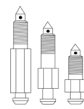

INDEKS
INDEX
ИНДЕКС



POŁOŻENIE
LOCATION
МЕСТО

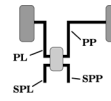

OPIS
DESCRIPTION
ОПИСАНИЕ

ZŁĄCZKA ZŁĄCZKA DŁUGOŚĆ
FITTING FITTING LENGTH
НАКОНЕЧНИК НАКОНЕЧНИК ДЛИНА

MARKA SAMOCHODU CAR MODEL МОДЕЛЬ АВТОМБИЯ	NUMER ZESTAWU SET NUMBER НОМЕР НАБОРА	ROK PRODUKCJI PRODUCTION YEAR ГОД ВЫПУСКА АВТОМБИЯ	ODPOWIETRZNIK BLEEDER SCREW ШТУЦЕР ПРОКАЧКИ ТОРМОЗОВ	INDEKS INDEX ИНДЕКС	POŁOŻENIE LOCATION МЕСТО	OPIS DESCRIPTION ОПИСАНИЕ
Fiat Ducato						
1400, 1800 bez ABS, rozstaw osi 3200 mm without ABS, wheel base 3200 mm без ABS, колесная база 3200 мм	ZWP-5719	03.94>03.02	0100P	WP-115	PL	105 105 1150
				WP-027	PL+	105 105 1250
				WP-014	PP	105 105 2400
				WP-706	PP+	105 105 2450
				WP-117	TL	105 105 0750
				WP-356	TP	105 105 1450
				WP-012	SP	105 105 1650
				WP-404	ST	105 105 2550
Fiat Ducato						
1400, 1800 bez ABS, rozstaw osi 3700 mm without ABS, wheel base 3700 mm без ABS, колесная база 3700 мм	ZWP-5720	03.94>03.02	0100P	WP-115	PL	105 105 1150
				WP-027	PL+	105 105 1250
				WP-014	PP	105 105 2400
				WP-706	PP+	105 105 2450
				WP-117	TL	105 105 0750
				WP-356	TP	105 105 1450
				WP-012	SP	105 105 1650
				WP-040	ST	105 105 3300
Fiat Ducato 30						
z ABS, krótki rozstaw osi with ABS, short wheel base с ABS, короткий колесная база	ZWP-5753	04.02>	0039P	WP-019	PL	105 105 1000
				WP-706	PP	105 105 2450
				WP-491	SPL	104 105 1800
				WP-1866	SPP	105 110X 1850
				WP-036	STL	105 105 2100
				WP-1867	STP	105 110X 2200
				WP-018	TL	105 105 0650
				WP-528	TP	104X 105 1350
Fiat Ducato 33						
z ABS, średni rozstaw osi with ABS, mid wheel base с ABS, длинная колесная база	ZWP-5754	04.02>	0039P	WP-019	PL	105 105 1000
				WP-706	PP	105 105 2450
				WP-491	SPL	104 105 1800
				WP-1866	SPP	105 110X 1850
				WP-167	STL	105 105 2600
				WP-1869	STP	105 110X 2650
				WP-018	TL	105 105 0650
				WP-528	TP	104X 105 1350
Fiat Ducato 35						
z ABS, długi rozstaw osi with ABS, long wheel base с ABS, средний колесная база	ZWP-5755	04.02>	0039P	WP-019	PL	105 105 1000
				WP-706	PP	105 105 2450
				WP-491	SPL	104 105 1800
				WP-1866	SPP	105 110X 1850
				WP-040	STL	105 105 3300
				WP-1871	STP	105 110X 3350
				WP-017	TL	105 105 0500
				WP-506	TP	104X 105 1250
Fiat Marea						
Wszystkie modele z ABS BOSCH All models with ABS BOSCH Все модели с ABS BOSCH	ZWP-5721	10.98>08.02	0100P	WP-1697	PL	104X 105 1050
				WP-023	PP	105 105 1800
				WP-1678	TL	105 110X 0850
				WP-196	TP	105 105 1300
				WP-115	SPL	105 105 1150
				WP-1700	SPP	104X 110X 1150
				WP-440	STL	105 105 2150
				WP-1702	STP	110X 110X 2150
Fiat Marea						
Wszystkie modele z ABS LUCAS All models with ABS LUCAS Все модели с ABS LUCAS	ZWP-5722	10.98>08.02	0100P	WP-042	PL	105 105 1700
				WP-1697	PP	104X 105 1050
				WP-017	TL	105 105 0500
				WP-017	TP	105 105 0500
				WP-1687	SPL	105 110X 3250
				WP-1699	SPP	104X 105 3400
				WP-009	STL	105 105 0600
				WP-511	STP	104X 110X 0600
Fiat Multipla						
Wszystkie modele z ABS All models with ABS Все модели с ABS	ZWP-5723	02.99>08.04	0100P	WP-009	PL	105 105 0600
				WP-047	PP	105 105 1500
				WP-009	TL	105 105 0600
				WP-035	TP	105 105 1100
				WP-017	ZTL	105 105 0500
				WP-017	ZTP	105 105 0500
				WP-1683	CL	105 110X 1750
				WP-023	CP	105 105 1800
Fiat Duna						
Berlina Weekend VET.3113869-	ZWP-5724	87>91	0086P	WP-009	PL	105 105 0600
				WP-435	PP	105 105 1600
				WP-028	TL	105 105 0550
				WP-027	TP	105 105 1250
				WP-006	ZTL	105 105 0250
				WP-006	ZTP	105 105 0250
				WP-167	SP	105 105 2600
				WP-482	ST	105 105 1950

MARKA SAMOCHODU
CAR MODEL
МОДЕЛЬ АВТОМБИЯ

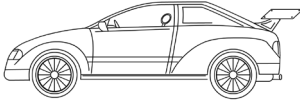

NUMER ZESTAWU
SET NUMBER
НОМЕР НАБОРА

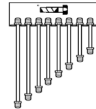

ROK PRODUKCJI
PRODUCTION YEAR
ГОД ВЫПУСКА АВТОМБИЯ



ODPOWIETRZNIK
BLEEDER SCREW
ШТУЦЕР ПРОКАЧКИ ТОРМОЗОВ

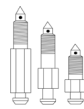

INDEKS
INDEX
ИНДЕКС



POŁOŻENIE
LOCATION
МЕСТО

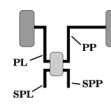

OPIS
DESCRIPTION
ОПИСАНИЕ

ZŁĄCZKA
FITTING
НАКОНЕЧНИК

ZŁĄCZKA
FITTING
НАКОНЕЧНИК

DŁUGOŚĆ
LENGTH
ДЛИНА

MARKA SAMOCHODU CAR MODEL МОДЕЛЬ АВТОМБИЯ	NUMER ZESTAWU SET NUMBER НОМЕР НАБОРА	ROK PRODUKCJI PRODUCTION YEAR ГОД ВЫПУСКА АВТОМБИЯ	ODPOWIETRZNIK BLEEDER SCREW ШТУЦЕР ПРОКАЧКИ ТОРМОЗОВ	INDEKS INDEX ИНДЕКС	POŁOŻENIE LOCATION МЕСТО	OPIS DESCRIPTION ОПИСАНИЕ
Fiat Palio Weekend						
1.6 16V z ABS with ABS c ABS	ZWP-5725	04.96>	0086P	WP-505	TL	105 104X 0600
				WP-505	TP	105 104X 0600
				WP-017	ZTL	105 105 0500
				WP-017	ZTP	105 105 0500
				WP-594	CL	104 105 4450
				WP-044	CP	105 105 4800
				WP-009	PL	105 105 0600
				WP-356	PP	105 105 1450
				WP-499	POM-ABS	104 105 0650
WP-309	POM-ABS	104 105 0700				
Fiat Panda						
45 (10 x 1,25)	ZWP-5726	80>86	0100P	WP-150	PL	112 112 0400
				WP-152	PP	112 112 1250
				WP-153	TL	112 112 0650
				WP-153	TP	112 112 0650
				WP-790	SP	112 112 3200
				WP-056	ST	112 112 0300
Fiat Panda Super (10 x 1)	ZWP-5727	80>86	0100P	WP-019	PL	105 105 1000
				WP-012	PP	105 105 1650
				WP-018	TL	105 105 0650
				WP-018	TP	105 105 0650
				WP-015	SP	105 105 2700
				WP-001	ST	105 105 0300
Fiat Panda Wszystkie modele All models Все модели	ZWP-5756	09.03>		WP-018	PL	105 105 0650
				WP-479	PP	104 105 1200
				WP-264	SPL	104 105 0750
				WP-1862	SPP	105 110X 0800
				WP-039	CL	105 105 1550
				WP-1868	CP	105 110X 2350
				WP-028	TL	105 105 0550
				WP-028	TP	105 105 0550
Fiat Punto 55, 60, 75, 90 bez ABS without ABS без ABS	ZWP-5728	93>08.99		WP-435	PL	105 105 1600
				WP-028	PP	105 105 0550
				WP-028	TL	105 105 0550
				WP-028	TP	105 105 0550
				WP-040	CL	105 105 3300
				WP-021	CP	105 105 3600
Fiat Punto 55, 60, 75, 90 z ABS with ABS c ABS	ZWP-5729	93>08.99		WP-019	PL	105 105 1000
				WP-049	PP	105 105 1900
				WP-028	TL	105 105 0550
				WP-028	TP	105 105 0550
				WP-167	CL	105 105 2600
				WP-1686	CP	105 110X 2800
Fiat Punto Wszystkie modele z ABS All models with ABS Все модели с ABS	ZWP-5757	09.99>05.03		WP-027	PL	105 105 1250
				WP-049	PP	105 105 1900
				WP-1681	SPL	105 110X 1150
				WP-1739	SPP	104X 105 1200
				WP-482	STL	105 105 1950
				WP-1686	STP	105 110X 2800
				WP-005	TL	105 105 0450
				WP-009	TP	105 105 0600
Fiat Regata Sedan, Weeken 1300, 1500, 1600, Diesel	ZWP-5730	86>91	0100P	WP-033	PL	105 105 0700
				WP-356	PP	105 105 1450
				WP-017	TL	105 105 0500
				WP-115	TP	105 105 1150
				WP-710	SP	105 105 3450
				WP-006	ST	105 105 0250
Fiat Ritmo 60L, 60CL, 65L Nr 2229823	ZWP-5731	78>83	0100P	WP-053	PL	112 112 0500
				WP-165	PP	112 112 1400
				WP-053	TL	112 112 0500
				WP-152	TP	112 112 1250
				WP-166	SP	112 112 3300
				WP-056	ST	112 112 0300
Fiat Ritmo 60L, 60CL, 65CL, 70CL, 75L, 75CL Nr 2229824-	ZWP-5732	78>83	0100P	WP-162	PL	112 112 0450
				WP-163	PP	112 112 1450
				WP-053	TL	112 112 0500
				WP-152	TP	112 112 1250
				WP-155	SP	112 112 3500
				WP-056	ST	112 112 0300

MARKA SAMOCHODU
CAR MODEL
МОДЕЛЬ АВТОМБИЯ

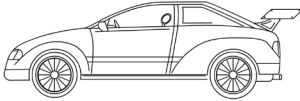

NUMER ZESTAWU
SET NUMBER
НОМЕР НАБОРА

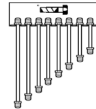

ROK PRODUKCJI
PRODUCTION YEAR
ГОД ВЫПУСКА АВТОМБИЯ



ODPOWIETRZNIK
BLEEDER SCREW
ШТУЦЕР ПРОКАЧКИ ТОРМОЗОВ

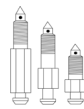

INDEKS
INDEX
ИНДЕКС



POŁOŻENIE
LOCATION
МЕСТО

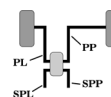

OPIS
DESCRIPTION
ОПИСАНИЕ

ZŁĄCZKA
FITTING
НАКОНЕЧНИК

ZŁĄCZKA
FITTING
НАКОНЕЧНИК

DŁUGOŚĆ
LENGTH
ДЛИНА

MARKA SAMOCHODU CAR MODEL МОДЕЛЬ АВТОМБИЯ	NUMER ZESTAWU SET NUMBER НОМЕР НАБОРА	ROK PRODUKCJI PRODUCTION YEAR ГОД ВЫПУСКА АВТОМБИЯ	ODPOWIETRZNIK BLEEDER SCREW ШТУЦЕР ПРОКАЧКИ ТОРМОЗОВ	INDEKS INDEX ИНДЕКС	POŁOŻENIE LOCATION МЕСТО	OPIS DESCRIPTION ОПИСАНИЕ
Fiat Seicento						
	ZWP-5747	94>		WP-724	PRL	105 105 0260
				WP-001	PRP	105 105 0300
				WP-943	ZTL	105 105 0490
				WP-943	ZTP	105 105 0490
				WP-1704	SPL	105 110X 1350
				WP-1681	SPP	105 110X 1100
				WP-932	PL	105 105 0720
				WP-049	PP	105 105 1900
				WP-036	CL	105 105 2100
				WP-390	CP	105 105 2250
Fiat Stilo						
Wszystkie modele z ABS, do Nr VET.367396 All models with ABS, to no. VET.367396 Все модели с ABS, к нет. VET.367396	ZWP-5733	10.01>	0015P	WP-115	PL	105 105 1150
				WP-010	PP	105 105 1850
				WP-017	TL	105 105 0500
				WP-017	TP	105 105 0500
				WP-1682	CL	105 110X 1650
				WP-015	CP	105 105 2700
Fiat Stilo						
Wszystkie modele z ABS, od Nr VET.367397 All models with ABS, from no. VET.367397 Все модели с ABS, от нет. VET.367397	ZWP-5734	10.01>	0015P	WP-024	PL	105 105 0800
				WP-1698	PP	104X 105 1750
				WP-017	TL	105 105 0500
				WP-017	TP	105 105 0500
				WP-1682	CL	105 110X 1650
				WP-015	CP	105 105 2700
Fiat Tempra						
1370cc, 1580cc Berlina, Kombi Nr 7122816	ZWP-5735	11.89>92	0100P	WP-024	PL	105 105 0800
				WP-435	PP	105 105 1600
				WP-009	TL	105 105 0600
				WP-019	TP	105 105 1000
				WP-028	ZTL	105 105 0550
				WP-028	ZTP	105 105 0550
				WP-531	SPL	104X 105 3000
				WP-008	SPP	105 105 3000
				WP-831	STL	104X 104X 0550
			0100T	WP-507	STP	104X 104X 0600
Fiat Tempra						
1370cc, 1580cc Berlina, Kombi Nr 7122817-	ZWP-5736	11.89>92	0100P	WP-024	PL	105 105 0800
				WP-435	PP	105 105 1600
				WP-018	TL	105 105 0650
				WP-523	TP	104X 105 1000
				WP-017	ZTL	105 105 0500
				WP-017	ZTP	105 105 0500
				WP-531	SPL	104X 105 3000
				WP-008	SPP	105 105 3000
				WP-507	STL	104X 104X 0600
			0100T	WP-018	STP	105 105 0650
Fiat Tempra						
1370cc, 1580cc bez ABS without ABS без ABS	ZWP-5737	93>09.96	0100P	WP-013	PL	105 105 0900
				WP-042	PP	105 105 1700
				WP-018	TL	105 105 0650
				WP-523	TP	104X 105 1000
				WP-017	ZTL	105 105 0500
				WP-017	ZTP	105 105 0500
				WP-433	SPL	105 105 2950
				WP-519	SPP	105 110X 2900
				WP-511	STL	104X 110X 0600
			0100T	WP-018	STP	105 105 0650
Fiat Tempra						
1370cc, 1580cc z ABS with ABS с ABS	ZWP-5738	93>09.96	0100P	WP-034	PL	105 105 1200
				WP-049	PP	105 105 1900
				WP-018	TL	105 105 0650
				WP-523	TP	104X 105 1000
				WP-005	ZTL	105 105 0450
				WP-005	ZTP	105 105 0450
				WP-008	SPL	105 105 3000
				WP-525	SPP	105 110X 3000
				WP-018	STL	105 105 0650
			0100T	WP-511	STP	104X 110X 0600
Fiat Tempra						
2,0iE	ZWP-5739	90>09.96	0100P	WP-196	PL	105 105 1300
				WP-042	PP	105 105 1700
				WP-009	TL	105 105 0600
				WP-314	TP	104 105 1000
				WP-045	ZTL	105 105 0400
				WP-045	ZTP	105 105 0400
				WP-045	SPL	105 105 0400
				WP-457	SPP	104 105 0400
				WP-008	STL	105 105 3000
*67			0100T	WP-532	STP	104 104 3000

MARKA SAMOCHODU
CAR MODEL
МОДЕЛЬ АВТОМБИЯ

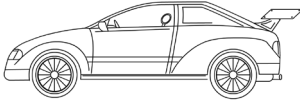

NUMER ZESTAWU
SET NUMBER
НОМЕР НАБОРА

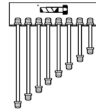

ROK PRODUKCJI
PRODUCTION YEAR
ГОД ВЫПУСКА АВТОМБИЯ



ODPOWIETRZNIK
BLEEDER SCREW
ШТУЦЕР ПРОКАЧКИ ТОРМОЗОВ

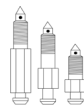

INDEKS
INDEX
ИНДЕКС



POŁOŻENIE
LOCATION
МЕСТО

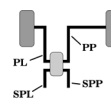

OPIS
DESCRIPTION
ОПИСАНИЕ

ZŁĄCZKA FITTING
НАКОНЕЧНИК
ZŁĄCZKA FITTING
НАКОНЕЧНИК
DŁUGOŚĆ LENGTH
ДЛИНА

MARKA SAMOCHODU CAR MODEL МОДЕЛЬ АВТОМБИЯ	NUMER ZESTAWU SET NUMBER НОМЕР НАБОРА	ROK PRODUKCJI PRODUCTION YEAR ГОД ВЫПУСКА АВТОМБИЯ	ODPOWIETRZNIK BLEEDER SCREW ШТУЦЕР ПРОКАЧКИ ТОРМОЗОВ	INDEKS INDEX ИНДЕКС	POŁOŻENIE LOCATION МЕСТО	OPIS DESCRIPTION ОПИСАНИЕ			
Fiat Tipo									
1100cc, 1400cc, 1600 bez ABS without ABS без ABS	ZWP-5741	88>92	0100P	WP-024	PL	105 105 0800			
				WP-435	PP	105 105 1600			
				WP-501	TL	104 105 0900			
				WP-022	TP	105 105 1350			
				WP-017	ZTL	105 105 0500			
				WP-017	ZTP	105 105 0500			
				WP-008	CL	105 105 3000			
				WP-209	CP	104 105 3000			
*73			0100T						
Fiat Tipo									
1370cc, 1580cc, Diesel, T-Diesel VET.0043969, 2173985 VET.2282628, 4091170 bez ABS without ABS без ABS	ZWP-5742	88>92	0100P	WP-024	PL	105 105 0800			
				WP-435	PP	105 105 1600			
				WP-009	TL	105 105 0600			
				WP-314	TP	104 105 1000			
				WP-017	ZTL	105 105 0500			
				WP-017	ZTP	105 105 0500			
				WP-008	SPL	105 105 3000			
				WP-209	SPP	104 105 3000			
				WP-502	STL	104 104 0600			
				WP-018	STP	105 105 0650			
*66 *74			0100T						
Fiat Tipo									
1370cc, 1580cc VET.0043970, 2173986, VET.2282629, 4091171 VET.2515394, 2608282, VET.4276939 bez ABS without ABS без ABS	ZWP-5743	88>92	0100P	WP-024	PL	105 105 0800			
				WP-435	PP	105 105 1600			
				WP-017	TL	105 105 0500			
				WP-017	TP	105 105 0500			
				WP-514	SPL	104X 105 2950			
				WP-008	SPP	105 105 3000			
				WP-832	STL	104X 105 0850			
				WP-022	STP	105 105 1350			
*66			0100T						
Fiat Tipo									
1370cc, 1580cc VET.2515395, 4208283 VET.4226940 bez ABS without ABS без ABS	ZWP-5744	88>92	0100P	WP-024	PL	105 105 0800			
				WP-435	PP	105 105 1600			
				WP-018	TL	105 105 0650			
				WP-523	TP	104X 105 1000			
				WP-017	ZTL	105 105 0500			
				WP-017	ZTP	105 105 0500			
				WP-514	SPL	104X 105 2950			
				WP-008	SPP	105 105 3000			
				WP-505	STL	104X 105 0600			
				WP-018	STP	105 105 0650			
*66			0100T						
Fiat Tipo									
1108cc, 1370cc, 1580cc bez ABS, bez turbo diesel without ABS, without turbo diesel без ABS, без turbo diesel	ZWP-5745	93>09.95	0100P	WP-013	PL	105 105 0900			
				WP-012	PP	105 105 1650			
				WP-018	TL	105 105 0650			
				WP-523	TP	104X 105 1000			
				WP-017	ZTL	105 105 0500			
				WP-017	ZTP	105 105 0500			
				WP-433	SPL	105 105 2950			
				WP-519	SPP	105 110X 2900			
				WP-018	STL	105 105 0650			
				WP-511	STP	104X 110X 0600			
				0100T					
				Fiat Tipo					
1108cc, 1370cc, 1580cc z ABS, bez turbo diesel with ABS, without turbo diesel с ABS, без turbo diesel	ZWP-5738	93>09.95	0100P	WP-034	PL	105 105 1200			
				WP-049	PP	105 105 1900			
				WP-018	TL	105 105 0650			
				WP-523	TP	104X 105 1000			
				WP-005	ZTL	105 105 0450			
				WP-005	ZTP	105 105 0450			
				WP-008	SPL	105 105 3000			
				WP-525	SPP	105 110X 3000			
				WP-018	STL	105 105 0650			
				WP-511	STP	104X 110X 0600			
0100T									
Fiat Tipo									
1750cc, 2000cc VET.2515394, 2608282 bez ABS without ABS без ABS	ZWP-5746	88>08.91	0100P	WP-024	PL	105 105 0800			
				WP-435	PP	105 105 1600			
				WP-009	TL	105 105 0600			
				WP-314	TP	104 105 1000			
				WP-017	ZTL	105 105 0500			
				WP-017	ZTP	105 105 0500			
				WP-209	SPL	104 105 3000			
				WP-709	SPP	105 105 3150			
				WP-582	STL	104 104 0550			
				WP-009	STP	105 105 0600			
*66			0100T						

MARKA SAMOCHODU
CAR MODEL
МОДЕЛЬ АВТОМБИЯ

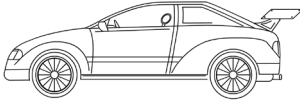

NUMER ZESTAWU
SET NUMBER
НОМЕР НАБОРА

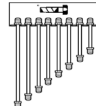

ROK PRODUKCJI
PRODUCTION YEAR
ГОД ВЫПУСКА АВТОМБИЯ



ODPOWIETRZNIK
BLEEDER SCREW
ШТУЦЕР ПРОКАЧКИ ТОРМОЗОВ

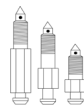

INDEKS
INDEX
ИНДЕКС



POŁOŻENIE
LOCATION
МЕСТО

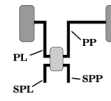

OPIS
DESCRIPTION
ОПИСАНИЕ

ZŁĄCZKA ZŁĄCZKA DŁUGOŚĆ
FITTING FITTING LENGTH
НАКОНЕЧНИК НАКОНЕЧНИК ДЛИНА

MARKA SAMOCHODU CAR MODEL МОДЕЛЬ АВТОМБИЯ	NUMER ZESTAWU SET NUMBER НОМЕР НАБОРА	ROK PRODUKCJI PRODUCTION YEAR ГОД ВЫПУСКА АВТОМБИЯ	ODPOWIETRZNIK BLEEDER SCREW ШТУЦЕР ПРОКАЧКИ ТОРМОЗОВ	INDEKS INDEX ИНДЕКС	POŁOŻENIE LOCATION МЕСТО	OPIS DESCRIPTION ОПИСАНИЕ
Fiat Tipo						
1750cc, 2000cc VET.2515395, 2608283 bez ABS without ABS без ABS	ZWP-5742	09.91>92	0100P	WP-024	PL	105 105 0800
				WP-435	PP	105 105 1600
				WP-009	TL	105 105 0600
				WP-314	TP	104 105 1000
				WP-017	ZTL	105 105 0500
				WP-017	ZTP	105 105 0500
				WP-008	SPL	105 105 3000
				WP-209	SPP	104 105 3000
				WP-502	STL	104 104 0600
				WP-018	STP	105 105 0650
*66			0100T			
Fiat Tipo						
1750cc, 2000cc bez ABS without ABS без ABS	ZWP-5748	88>	0100P	WP-024	PL	105 105 0800
				WP-435	PP	105 105 1600
				WP-009	TL	105 105 0600
				WP-314	TP	104 105 1000
				WP-005	ZTL	105 105 0450
				WP-005	ZTP	105 105 0450
				WP-209	SPL	104 105 3000
				WP-709	SPP	105 105 3150
				WP-582	STL	104 104 0550
				WP-009	STP	105 105 0600
*67			0100T			
Fiat Uno						
45	ZWP-5749	83>88	0100P	WP-009	PL	105 105 0600
				WP-252	PP	105 105 1050
				WP-022	TL	105 105 1350
				WP-005	TP	105 105 0450
				WP-015	SP	105 105 2700
				WP-022	ST	105 105 1350
*67			0100T			
Fiat Uno						
55	ZWP-5750	83>88	0100P	WP-028	PL	105 105 0550
				WP-034	PP	105 105 1200
				WP-022	TL	105 105 1350
				WP-005	TP	105 105 0450
				WP-032	SP	105 105 2800
				WP-003	ST	105 105 1400
*67			0100T			
Fiat Uno						
60S	ZWP-5750	83>88	0100P	WP-028	PL	105 105 0550
				WP-034	PP	105 105 1200
				WP-022	TL	105 105 1350
				WP-005	TP	105 105 0450
				WP-032	SP	105 105 2800
				WP-003	ST	105 105 1400
*67			0100T			
Fiat Uno						
70	ZWP-5752	83>88	0100P	WP-045	PL	105 105 0400
				WP-035	PP	105 105 1100
				WP-022	TL	105 105 1350
				WP-045	TP	105 105 0400
				WP-032	SP	105 105 2800
				WP-022	ST	105 105 1350
*67			0100T			
Fiat Uno						
Wszystkie modele, bez turbo All models, without turbo Все модели, без turbo	ZWP-5753	89>95	0100P	WP-017	PL	105 105 0500
				WP-034	PP	105 105 1200
				WP-196	TL	105 105 1300
				WP-005	TP	105 105 0450
				WP-533	CC	105 105 2750
*67			0100T			
Ford Capri II						
Wszystkie modele All models Все модели	ZWP-5801	75>84	0039P	WP-091	ZPL	105 106 0250
				WP-091	ZPP	105 106 0250
				WP-174	PL	105 106 0750
				WP-560	PP	105 106 2050
				WP-114	TL	105 106 0350
				WP-047	TP	105 105 1500
				WP-176	CC	105 106 3700
*73			0039T			
Ford Consul						
Wszystkie modele All models Все модели	ZWP-5802	72>09.77	0085P	WP-091	ZPL	105 106 0250
				WP-091	ZPP	105 106 0250
				WP-101	PL	105 106 0200
				WP-188	PP	105 106 1250
				WP-174	TL	105 106 0750
				WP-174	TP	105 106 0750
				WP-115	SP	105 105 1150
				WP-048	ST	105 105 2500
				*73		
Ford Consul						
Wszystkie modele All models Все модели	ZWP-5802	72>09.77	0085P	WP-091	ZPL	105 106 0250
				WP-091	ZPP	105 106 0250
				WP-101	PL	105 106 0200
				WP-188	PP	105 106 1250
				WP-174	TL	105 106 0750
				WP-174	TP	105 106 0750
				WP-115	SP	105 105 1150
				WP-048	ST	105 105 2500
				*74		

MARKA SAMOCHODU
CAR MODEL
МОДЕЛЬ АВТОМБИЯ

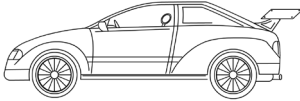

NUMER ZESTAWU
SET NUMBER
НОМЕР НАБОРА

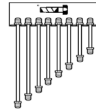

ROK PRODUKCJI
PRODUCTION YEAR
ГОД ВЫПУСКА АВТОМБИЯ



ODPOWIETRZNIK
BLEEDER SCREW
ШТУЦЕР ПРОКАЧКИ ТОРМОЗОВ

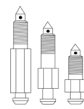

INDEKS
INDEX
ИНДЕКС



POŁOŻENIE
LOCATION
МЕСТО

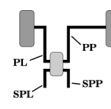

OPIS
DESCRIPTION
ОПИСАНИЕ

ZŁĄCZKA ZŁĄCZKA DŁUGOŚĆ
FITTING FITTING LENGTH
НАКОНЕЧНИК НАКОНЕЧНИК ДЛИНА

MARKA SAMOCHODU CAR MODEL МОДЕЛЬ АВТОМБИЯ	NUMER ZESTAWU SET NUMBER НОМЕР НАБОРА	ROK PRODUKCJI PRODUCTION YEAR ГОД ВЫПУСКА АВТОМБИЯ	ODPOWIETRZNIK BLEEDER SCREW ШТУЦЕР ПРОКАЧКИ ТОРМОЗОВ	INDEKS INDEX ИНДЕКС	POŁOŻENIE LOCATION МЕСТО	OPIS DESCRIPTION ОПИСАНИЕ	
Ford Cortina							
1.3, 1.6, 2.0, 2.3	ZWP-5804	08.76>07.79	0039P	WP-091	ZPL	105 106 0250	
				WP-091	ZPP	105 106 0250	
				WP-102	PL	105 106 0800	
				WP-194	PP	105 106 1400	
				WP-090	TL	105 106 0650	
				WP-047	TP	105 105 1500	
				WP-196	SP	105 105 1300	
				WP-560	ST	105 106 2050	
Ford Cortina							
1.3, 1.6, 2.0, 2.3	ZWP-5805	08.79>82	0039P	WP-091	ZPL	105 106 0250	
				WP-091	ZPP	105 106 0250	
				WP-448	PL	105 106 0850	
				WP-190	PP	105 106 1700	
				WP-090	TL	105 106 0650	
				WP-047	TP	105 105 1500	
				WP-027	SP	105 105 1250	
				WP-560	ST	105 106 2050	
Ford Escort							
Wszystkie modele All models Все модели *69 *72 *74	ZWP-5806	75>08.80	0049P	WP-091	ZPL	105 106 0250	
				0039P	WP-091	ZPP	105 106 0250
					WP-174	PL	105 106 0750
					WP-190	PP	105 106 1700
			WP-022		TL	105 105 1350	
			0039T	WP-110	TP	105 106 0550	
				WP-187	CC	105 106 2200	
				Ford Escort			
Wszystkie modele All models Все модели	ZWP-5807	08.80>03.81		0019P	WP-448	PL	105 106 0850
			WP-113		PP	105 106 1850	
			WP-091		TL	105 106 0250	
			WP-091		TP	105 106 0250	
			0039T		WP-050	CL	105 105 4100
					WP-046	CP	105 105 3500
Ford Escort							
Wszystkie modele All models Все модели	ZWP-5808	03.81>10.83	0019P	WP-448	PL	105 106 0850	
				WP-113	PP	105 106 1850	
				WP-091	TL	105 106 0250	
				WP-091	TP	105 106 0250	
				0039T	WP-702	CL	104 106 3950
					WP-202	CP	104 106 3500
Ford Escort III							
Wszystkie modele, bez 1.3LX, 1.6LX (Brazylia) All models, without 1.3LX, 1.6LX (Brazylia) Все модели, без 1.3LX, 1.6LX (Brazylia)	ZWP-5809	10.83>85	0019P	WP-448	PL	105 106 0850	
				WP-598	PP	104 106 1550	
				WP-091	TL	105 106 0250	
				WP-091	TP	105 106 0250	
				0039T	WP-176	CL	105 106 3700
					WP-093	CP	105 106 3000
Ford Escort III							
1.3LX, 1.6LX (Brazylia)	ZWP-5810	12.83>85	0019P	WP-448	PL	105 106 0850	
				WP-113	PP	105 106 1850	
				WP-091	TL	105 106 0250	
				WP-091	TP	105 106 0250	
				0039T	WP-202	CL	104 106 3500
					WP-202	CP	104 106 3500
Ford Escort IV							
Wszystkie modele, bez ALB All models, without ALB Все модели, без ALB	ZWP-5811	01.86>07.90	0019P	WP-104	PL	105 106 1000	
				WP-198	PP	105 106 1350	
				WP-111	ZTL	105 106 0300	
				WP-111	ZTP	105 106 0300	
				0039T	WP-192	CL	105 106 3400
					WP-432	CP	105 105 3250
Ford Escort IV							
Wszystkie modele, z ALB All models, with ALB Все модели, с ALB	ZWP-5812	01.86>07.90	0019P	WP-448	PL	105 106 0850	
				WP-090	PP	105 106 0650	
				WP-107	TL	105 106 1300	
				WP-107	TP	105 106 1300	
				WP-091	ZTL	105 106 0250	
				WP-091	ZTP	105 106 0250	
				WP-560	SPL	105 106 2050	
				WP-167	SPP	105 105 2600	
				0039T	WP-167	STL	105 105 2600
					WP-445	STP	105 106 2300
Ford Eskort V							
Wszystkie modele z ABS model III, bez kombi All models, with ABS model III, without combi Все модели, с ABS модел III, без combi	ZWP-5858	08.90>01.95		WP-495	PL	104 105 1300	
				WP-482	PP	105 105 1950	
				WP-499	SPL	104 105 0650	
				WP-499	SPP	105 106 0650	
				WP-459	STL	105 106 1500	
				WP-194	STP	105 106 1400	
				WP-512	TL	104 106 0900	
				WP-188	TP	105 106 1250	

MARKA SAMOCHODU
CAR MODEL
МОДЕЛЬ АВТОМБИЛЯ

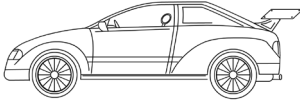

NUMER ZESTAWU
SET NUMBER
НОМЕР НАБОРА

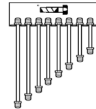

ROK PRODUKCJI
PRODUCTION YEAR
ГОД ВЫПУСКА АВТОМБИЛЯ



ODPOWIETRZNIK
BLEEDER SCREW
ШТУЦЕР ПРОКАЧКИ ТОРМОЗОВ

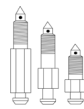

INDEKS
INDEX
ИНДЕКС



POŁOŻENIE
LOCATION
МЕСТО

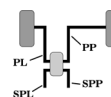

OPIS
DESCRIPTION
ОПИСАНИЕ

ZŁĄCZKA ZŁĄCZKA DŁUGOŚĆ
FITTING FITTING LENGTH
НАКОНЕЧНИК НАКОНЕЧНИК ДЛИНА

MARKA SAMOCHODU CAR MODEL МОДЕЛЬ АВТОМБИЛЯ	NUMER ZESTAWU SET NUMBER НОМЕР НАБОРА	ROK PRODUKCJI PRODUCTION YEAR ГОД ВЫПУСКА АВТОМБИЛЯ	ODPOWIETRZNIK BLEEDER SCREW ШТУЦЕР ПРОКАЧКИ ТОРМОЗОВ	INDEKS INDEX ИНДЕКС	POŁOŻENIE LOCATION МЕСТО	OPIS DESCRIPTION ОПИСАНИЕ				
Ford Eskort V										
Wszystkie modele, z ABS model IV, bez kombi All models, with ABS model IV, without combi Все модели, с ABS модел IV, без combi	ZWP-5813	08.90>01.95	0039P	WP-103	PL	104 106 1400				
				WP-560	PP	105 106 2050				
				WP-561	TL	104 106 1000				
				WP-561	TP	104 106 1000				
				WP-435	SPL	105 105 1600				
				WP-198	SPP	105 106 1350				
				WP-356	STL	105 105 1450				
				WP-200	STP	105 106 1900				
Ford Eskort V										
Wszystkie modele, bez ABS, bez kombi All models, without ABS, without combi Все модели, без ABS, без combi	ZWP-5859	08.90>01.95		WP-495	PL	104 105 1300				
				WP-197	PP	105 106 1750				
				WP-444	SPL	105 106 0950				
				WP-019	SPP	105 105 1000				
				WP-194	STL	105 106 1400				
				WP-112	STP	105 106 1550				
				WP-188	TL	105 106 1250				
				WP-761	TP	106 106 1800				
Ford Eskort V										
Kombi, bez ABS Combi, without ABS Combi, без ABS	ZWP-5814	08.90>12.94	0039P	WP-512	PL	104 106 0900				
				WP-113	PP	105 106 1850				
				WP-192	CL	105 106 3400				
				WP-572	CP	105 106 3950				
Ford Eskort V										
Kombi, z ABS Combi, with ABS Combi, с ABS	ZWP-5815	08.90>12.94	0039P	WP-1898	PL	104 108s 0800				
				WP-1899	PP	105 108s 1200				
				WP-562	SPL	104 106 1600				
				WP-435	SPP	105 105 1600				
				WP-563	STL	105 106 2500				
Ford Eskort V										
Wszystkie modele z ABS, bez kombi All models, with ABS, without combi Все модели, с ABS, без combi	ZWP-5816	01.95>06.98	0039P	WP-495	PL	104 105 1300				
				WP-049	PP	105 105 1900				
				WP-103	TL	105 106 1400				
				WP-1734	TP	106 106 1900				
				WP-112	CL	105 106 1550				
Ford Eskort V										
Wszystkie modele z ABS, bez kombi All models, with ABS, without combi Все модели, с ABS, без combi	ZWP-5860	07.98>02.99		WP-174	PL	105 106 0750				
				WP-049	PP	105 105 1900				
				WP-112	CL	105 106 1550				
				WP-194	CP	105 106 1400				
				WP-194	TL	105 106 1400				
Ford Eskort V										
Wszystkie modele, z ALB, bez kombi All models, with ALB, without combi Все модели, с ALB, без combi	ZWP-5861	01.95>02.99		WP-495	PL	104 105 1300				
				WP-049	PP	105 105 1900				
				WP-112	SPL	105 106 1550				
				WP-194	SPP	105 106 1400				
				WP-495	STL	104 105 1300				
				WP-560	STP	105 106 2050				
				WP-1727	TL	104 106 0650				
				WP-448	TP	105 106 0850				
Ford Eskort										
Kombi Combi	ZWP-5817	01.95>02.99	0039P	WP-524	PL	104 106 1300				
				WP-520	PP	105 106 1950				
				WP-112	SPL	105 106 1550				
				WP-194	SPP	105 106 1400				
				WP-047	STL	105 105 1500				
				WP-560	STP	105 106 2050				
				WP-496	TL	104 105 1050				
				WP-496	TP	104 105 1050				
Ford Fiesta										
Wszystkie modele, bez Szwecji All models, without Sweden Все модели, без Швеции	ZWP-5818	76>09.83	0039P	WP-102	PL	105 106 0800				
				WP-112	PP	105 106 1550				
				WP-210	TL	104 105 1550				
				WP-028	TP	105 105 0550				
				WP-028	ZTL	105 105 0550				
				WP-028	ZTP	105 105 0550				
				WP-209	CL	104 105 3000				
				WP-439	CP	104 105 2900				
				Ford Fiesta						
				Szwecja Sweden Швеция	ZWP-5819	76>09.83	0039P	WP-102	PL	105 106 0800
WP-112	PP	105 106 1550								
WP-210	TL	104 105 1550								
WP-028	TP	105 105 0550								
WP-028	ZTL	105 105 0550								
WP-028	ZTP	105 105 0550								
WP-004	CL	105 105 3100								
WP-590	CP	104 105 3300								

MARKA SAMOCHODU
CAR MODEL
МОДЕЛЬ АВТОМБИЯ

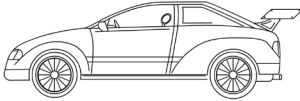

NUMER ZESTAWU
SET NUMBER
НОМЕР НАБОРА

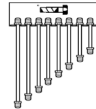

ROK PRODUKCJI
PRODUCTION YEAR
ГОД ВЫПУСКА АВТОМБИЯ



ODPOWIETRZNIK
BLEEDER SCREW
ШТУЦЕР ПРОКАЧКИ ТОРМОЗОВ

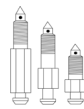

INDEKS
INDEX
ИНДЕКС



POŁOŻENIE
LOCATION
МЕСТО

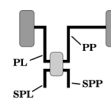

OPIS
DESCRIPTION
ОПИСАНИЕ

ZŁĄCZKA FITTING
НАКОНЕЧНИК
ZŁĄCZKA FITTING
НАКОНЕЧНИК
DŁUGOŚĆ LENGTH
ДЛИНА

MARKA SAMOCHODU CAR MODEL МОДЕЛЬ АВТОМБИЯ	NUMER ZESTAWU SET NUMBER НОМЕР НАБОРА	ROK PRODUKCJI PRODUCTION YEAR ГОД ВЫПУСКА АВТОМБИЯ	ODPOWIETRZNIK BLEEDER SCREW ШТУЦЕР ПРОКАЧКИ ТОРМОЗОВ	INDEKS INDEX ИНДЕКС	POŁOŻENIE LOCATION МЕСТО	OPIS DESCRIPTION ОПИСАНИЕ				
Ford Fiesta										
Wszystkie modele All models Все модели *72 *74	ZWP-5820	10.83>12.88	0019P	WP-102	PL	105 106 0800				
				WP-112	PP	105 106 1550				
				WP-039	TL	105 105 1550				
				WP-028	TP	105 105 0550				
				WP-028	ZTL	105 105 0550				
				WP-028	ZTP	105 105 0550				
				WP-008	CL	105 105 3000				
				WP-439	CP	104 105 2900				
				0039T						
				Ford Fiesta						
Wszystkie modele z ABS	ZWP-5821	01.89>07.95	0019P	WP-561	PL	104 106 1000				
				WP-428	PP	105 105 2050				
				WP-102	TL	105 106 0800				
				WP-102	TP	105 106 0800				
				WP-108	ZTL	105 106 0400				
				WP-108	ZTP	105 106 0400				
				WP-283	SPL	104 105 0550				
				WP-005	SPP	105 105 0450				
				WP-446	STL	105 106 3300				
				0053T	WP-718	STP	105 106 3550			
Ford Fiesta										
Wszystkie modele All models Все модели	ZWP-5822	08.95>03.02	0019P	WP-760	PL	106 106 0750				
				WP-207	PP	105 106 1600				
				WP-1900	TP	106 106 1250				
				WP-188	TL	105 106 1250				
				WP-490	SPL	104 105 0350				
				WP-114	SPP	105 106 0350				
				WP-762	STL	106 106 2100				
				0039T	WP-192	STP	105 106 3400			
				Ford Focus						
				Wszystkie modele, z ABS All models, with ABS Все модели, с ABS *67	ZWP-5823	01.98>10.04	0011P	WP-005	PL	105 105 0450
WP-385	PP	105 106 0450								
WP-035	PP+	105 105 1100								
WP-035	TL	105 106 1100								
WP-104	TP	105 106 1000								
WP-006	ZTL	105 105 0250								
WP-006	ZTP	105 105 0250								
WP-199	SPL	105 106 0900								
WP-444	SPP	105 106 0950								
WP-042	STL	105 105 1700								
0039T	WP-042	STP	105 105 1700							
Ford Focus										
*66	ZWP-5824	01.98>10.04	0011P					WP-045	PL	105 105 0400
				WP-385	PP	105 106 0450				
				WP-252	PP+	105 105 1050				
				WP-109	TL	105 106 1100				
				WP-104	TP	105 106 1000				
				WP-041	ZTL	105 105 0350				
				WP-041	ZTP	105 105 0350				
				WP-199	SPL	105 106 0900				
				WP-199	SPP	105 106 0900				
				WP-042	STL	105 105 1700				
				0039T	WP-042	STP	105 105 1700			
				Ford Galaxy						
				bez ABS without ABS без ABS	ZWP-5825	11.94>	0086P	WP-024	PL	105 105 0800
								WP-012	PP	105 105 1650
WP-024	TL	105 105 0800								
WP-024	TP	105 105 0800								
WP-042	SPL	105 105 1700								
WP-197	SPP	105 106 1750								
0087T	WP-023	STL	105 105 1800							
0087T	WP-023	STP	105 105 1800							
Ford Galaxy										
z ABS with ABS с ABS	ZWP-5826	09.95>08.97	0086P	WP-037	PL	105 107 0800				
				WP-428	PP	105 105 2050				
				WP-024	TL	105 105 0800				
				WP-024	TP	105 105 0800				
				WP-880	KOR	104 106 0550				
				WP-090	KOR	105 106 0650				
				WP-457	POM-ABS	104 105 0400				
				WP-441	POM-ABS	104 105 0500				
				WP-042	SPL	105 105 1700				
				WP-197	SPP	105 106 1750				
				0087T	WP-023	STL	105 105 1800			
				0087T	WP-023	STP	105 105 1800			

MARKA SAMOCHODU
CAR MODEL
МОДЕЛЬ АВТОМБИЯ

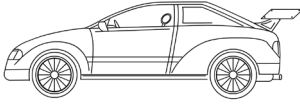

NUMER ZESTAWU
SET NUMBER
НОМЕР НАБОРА

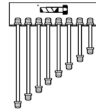

ROK PRODUKCJI
PRODUCTION YEAR
ГОД ВЫПУСКА АВТОМБИЯ



ODPOWIETRNIK
BLEEDER SCREW
ШТУЦЕР ПРОКАЧКИ ТОРМОЗОВ

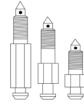

INDEKS
INDEX
ИНДЕКС



POŁOŻENIE
LOCATION
МЕСТО

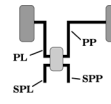

OPIS
DESCRIPTION
ОПИСАНИЕ

ZŁĄCZKA ZŁĄCZKA DŁUGOŚĆ
FITTING FITTING LENGTH
НАКОНЕЧНИК НАКОНЕЧНИК ДЛИНА

MARKA SAMOCHODU CAR MODEL МОДЕЛЬ АВТОМБИЯ	NUMER ZESTAWU SET NUMBER НОМЕР НАБОРА	ROK PRODUKCJI PRODUCTION YEAR ГОД ВЫПУСКА АВТОМБИЯ	ODPOWIETRNIK BLEEDER SCREW ШТУЦЕР ПРОКАЧКИ ТОРМОЗОВ	INDEKS INDEX ИНДЕКС	POŁOŻENIE LOCATION МЕСТО	OPIS DESCRIPTION ОПИСАНИЕ			
Ford Galaxy									
Wszystkie modele, z ABS All models, with ABS Все модели, с ABS	ZWP-5827	09.97>	0086P	WP-309	PL	104 105 0700			
				WP-428	PP	105 105 2050			
				WP-024	TL	105 105 0800			
				WP-024	TP	105 105 0800			
				WP-042	SPL	105 105 1700			
				WP-256	SPP	105 106 1750			
				WP-023	STL	105 105 1800			
				WP-023	STP	105 105 1800			
Ford Granada									
Wszystkie modele All models Все модели	ZWP-5828	09.77>11.80	0039P	WP-091	ZPL	105 106 0250			
				WP-091	ZPP	105 106 0250			
				WP-090	PL	105 106 0650			
				WP-112	PP	105 106 1550			
				WP-104	TL	105 106 1000			
				WP-104	TP	105 106 1000			
				WP-196	SP	105 105 1300			
				WP-014	ST	105 105 2400			
Ford Granada									
Wszystkie modele All models Все модели	ZWP-5829	12.80>85	0039P	WP-091	ZPL	105 106 0250			
				WP-091	ZPP	105 106 0250			
				WP-195	PL	105 106 0700			
				WP-112	PP	105 106 1550			
				WP-104	TL	105 106 1000			
				WP-104	TP	105 106 1000			
				WP-027	SP	105 105 1250			
				WP-014	ST	105 105 2400			
Ford Ka									
Wszystkie modele, z ABS All models, with ABS Все модели, с ABS	ZWP-5830	11.96-04	0019P	WP-110	PL	105 106 0550			
				WP-049	PL+	105 105 1900			
				WP-190	PP	105 106 1700			
				WP-190	PP+	105 105 1900			
				WP-110	TL	105 106 0550			
				WP-047	TL+	105 105 1500			
				WP-252	TP	105 105 1050			
				WP-715	SP	105 106 1800			
				WP-013	ST	105 105 0900			
				*74	0039T				
Ford Ka									
Wszystkie modele, z ABS All models, with ABS Все модели, с ABS	ZWP-5831	11.96>04	0019P	WP-448	PL	105 106 0850			
				WP-197	PP	105 106 1750			
				WP-112	TL	105 106 1550			
				WP-1690	TP	106 106 0700			
				WP-023	SPL	105 105 1800			
				WP-761	SPP	106 106 1800			
				WP-520	STL	105 106 1950			
				WP-036	STP	105 105 2100			
				*91	0039T				
				Ford Mondeo					
Sedan z ABS with ABS с ABS	ZWP-5832	01.93>08.96	0019P	WP-489	PL	104 105 1100			
				WP-035	PP	105 105 1100			
				WP-494	TL	104 105 1600			
				WP-512	TP	104 106 0900			
				WP-041	ZTL	105 105 0350			
				WP-041	ZTP	105 105 0350			
				WP-045	SPL	105 105 0400			
				WP-091	SPP	105 106 0250			
				WP-516	STL	106 106 3000			
				WP-529	STP	105 106 2800			
				0039T					
Ford Mondeo									
Kombi z ABS with ABS с ABS	ZWP-5833	01.93>08.96	0019P	WP-489	PL	104 105 1100			
				WP-035	PP	105 105 1100			
				WP-088	ZTL	105 106 0150			
				WP-088	ZTP	105 106 0150			
				WP-045	SPL	105 105 0400			
				WP-091	SPP	105 106 0250			
				WP-572	STL	105 106 3950			
				WP-534	STP	105 105 3750			
0039T									
Ford Mondeo									
Sedan z ABS with ABS с ABS	ZWP-5834	09.96>09.00	0019P	WP-005	PL	105 105 0450			
				WP-043	PP	105 105 0200			
				WP-104	PP+	105 106 1000			
				WP-047	TL	105 105 1500			
				WP-104	TP	105 106 1000			
				WP-205	SPL	105 105 0150			
				WP-205	SPP	105 105 0150			
				WP-1674	STL	105 106 2950			
				WP-1674	STP	105 106 2950			
0039T									

MARKA SAMOCHODU
CAR MODEL
МОДЕЛЬ АВТОМБИЯ

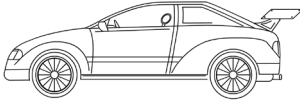

NUMER ZESTAWU
SET NUMBER
НОМЕР НАБОРА

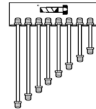

ROK PRODUKCJI
PRODUCTION YEAR
ГОД ВЫПУСКА АВТОМБИЯ



ODPOWIETRZNIK
BLEEDER SCREW
ШТУЦЕР ПРОКАЧКИ ТОРМОЗОВ

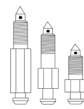

INDEKS
INDEX
ИНДЕКС



POŁOŻENIE
LOCATION
МЕСТО

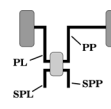

OPIS
DESCRIPTION
ОПИСАНИЕ

ZŁĄCZKA ZŁĄCZKA DŁUGOŚĆ
FITTING FITTING LENGTH
НАКОНЕЧНИК НАКОНЕЧНИК ДЛИНА

MARKA SAMOCHODU CAR MODEL МОДЕЛЬ АВТОМБИЯ	NUMER ZESTAWU SET NUMBER НОМЕР НАБОРА	ROK PRODUKCJI PRODUCTION YEAR ГОД ВЫПУСКА АВТОМБИЯ	ODPOWIETRZNIK BLEEDER SCREW ШТУЦЕР ПРОКАЧКИ ТОРМОЗОВ	INDEKS INDEX ИНДЕКС	POŁOŻENIE LOCATION МЕСТО	OPIS DESCRIPTION ОПИСАНИЕ
Ford Mondeo						
Kombi z ABS with ABS c ABS	ZWP-5835	09.96>09.00	0019P	WP-005	PL	105 105 0450
				WP-043	PP	105 105 0200
				WP-104	PP+	105 106 1000
				WP-198	TL	105 106 1350
				WP-107	TP	105 106 1300
				WP-043	ZTL	105 105 0200
				WP-043	ZTP	105 105 0200
				WP-205	SPL	105 105 0150
				WP-205	SPP	105 105 0150
				WP-1674	STL	105 106 2950
				0039T	WP-1674	STP
Ford Mondeo						
Sedan z ABS with ABS c ABS	ZWP-5836	10.00>08.04	0019P	WP-033	PL	105 105 0700
				WP-109	PP	105 106 1100
				WP-042	TL	105 105 1700
				WP-188	TP	105 106 1250
				WP-1709	CL	106 106 2950
				0039T	WP-433	CP
Ford Mondeo						
Kombi z ABS with ABS c ABS	ZWP-5837	10.00>08.04	0019P	WP-033	PL	105 105 0700
				WP-109	PP	105 106 1100
				WP-459	TL	105 106 1500
				WP-104	TP	106 106 1000
				WP-006	ZTL	105 105 0250
				WP-006	ZTP	105 105 0250
				WP-1709	CL	106 106 2950
				0039T	WP-433	CP
Ford Orion						
Wszystkie modele All models Все модели	ZWP-5809	05.83>85	0019P	WP-448	PL	105 106 0850
				WP-598	PP	104 106 1550
				WP-091	TL	105 106 0250
				WP-091	TP	105 106 0250
				WP-176	CL	105 106 3700
				0039T	WP-093	CP
Ford Orion						
Wszystkie modele All models Все модели	ZWP-5812	01.86>07.90	0019P	WP-448	PL	105 106 0850
				WP-090	PP	105 106 0650
				WP-107	TL	105 106 1300
				WP-107	TP	105 106 1300
				WP-091	ZTL	105 106 0250
				WP-091	ZTP	105 106 0250
				WP-560	SPL	105 106 2050
				WP-167	SPP	105 105 2600
				WP-167	STL	105 105 2600
				0039T	WP-445	STP
Ford P - 100						
Wszystkie modele All models Все модели	ZWP-5841	10.87>93	0019P	WP-110	PL	105 106 0550
				WP-088	PP	105 106 0150
				WP-197	PP+	105 106 1750
				WP-252	TL	105 105 1050
				WP-009	TP	105 105 0600
				WP-190	SP	105 106 1700
				0069T	WP-444	ST
Ford P - 100						
Wszystkie modele All models Все модели	ZWP-5842	02.85>91	0019P	WP-758	PL	106 106 0400
				WP-088	PP	105 106 0150
				WP-761	PP+	106 106 1800
				WP-091	TL	105 106 0250
				WP-195	TP	105 106 0700
				WP-759	ZTL	106 106 0550
				WP-759	ZTP	106 106 0550
				0039T	WP-722	CC
Ford Sierra						
Sedan 1.6, 1.8, 2.0, 2.3	ZWP-5843	08.82>92	0019P	WP-114	PL	105 106 0350
				WP-190	PP	105 106 1700
				WP-101	TL	105 106 0200
				WP-090	TP	105 106 0650
				WP-110	ZTL	105 106 0550
				WP-110	ZTP	105 106 0550
				0039T	WP-589	CC
Ford Sierra						
Kombi 1.6, 1.8, 2.0, 2.3	ZWP-5844	09.82>92	0019P	WP-114	PL	105 106 0350
				WP-197	PP	105 106 1750
				WP-101	TL	105 106 0200
				WP-195	TP	105 106 0700
				WP-090	ZTL	105 106 0650
				WP-090	ZTP	105 106 0650
				0039T	WP-701	CC

MARKA SAMOCHODU
CAR MODEL
МОДЕЛЬ АВТОМБИЛЯ

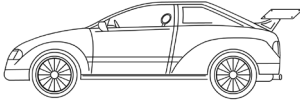

NUMER ZESTAWU
SET NUMBER
НОМЕР НАБОРА

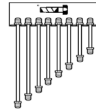

ROK PRODUKCJI
PRODUCTION YEAR
ГОД ВЫПУСКА АВТОМБИЛЯ



ODPOWIETRZNIK
BLEEDER SCREW
ШТУЦЕР ПРОКАЧКИ ТОРМОЗОВ

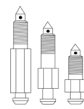

INDEKS
INDEX
ИНДЕКС



POŁOŻENIE
LOCATION
МЕСТО

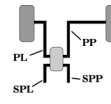

OPIS
DESCRIPTION
ОПИСАНИЕ

ZŁĄCZKA
FITTING
НАКОНЕЧНИК

ZŁĄCZKA
FITTING
НАКОНЕЧНИК

DŁUGOŚĆ
LENGTH
ДЛИНА

MARKA SAMOCHODU CAR MODEL МОДЕЛЬ АВТОМБИЛЯ	NUMER ZESTAWU SET NUMBER НОМЕР НАБОРА	ROK PRODUKCJI PRODUCTION YEAR ГОД ВЫПУСКА АВТОМБИЛЯ	ODPOWIETRZNIK BLEEDER SCREW ШТУЦЕР ПРОКАЧКИ ТОРМОЗОВ	INDEKS INDEX ИНДЕКС	POŁOŻENIE LOCATION МЕСТО	OPIS DESCRIPTION ОПИСАНИЕ				
Ford Taunus										
1.3, 1.6, 2.0, 2.3	ZWP-5804	12.75>07.79	0039P	WP-091	ZPL	105 106 0250				
				WP-091	ZPP	105 106 0250				
				WP-102	PL	105 106 0800				
				WP-194	PP	105 106 1400				
				WP-090	TL	105 106 0650				
				WP-047	TP	105 105 1500				
				WP-196	SP	105 105 1300				
				WP-560	ST	105 106 2050				
Ford Taunus										
1.3, 1.6, 2.0, 2.3	ZWP-5805	08.79>82	0039P	WP-091	ZPL	105 106 0250				
				WP-091	ZPP	105 106 0250				
				WP-448	PL	105 106 0850				
				WP-190	PP	105 106 1700				
				WP-090	TL	105 106 0650				
				WP-047	TP	105 105 1500				
				WP-027	SP	105 105 1250				
				WP-560	ST	105 106 2050				
Ford Transit										
60, 100, 115, 125 *69 *74	ZWP-5847	11.73>05.76	0039P 0018P	WP-005	ZPL	105 105 0450				
				WP-005	ZPP	105 105 0450				
				WP-024	PL	105 105 0800				
				WP-039	PP	105 105 1550				
				WP-024	TL	105 105 0800				
				WP-035	TP	105 105 1100				
				WP-049	SP	105 105 1900				
				WP-027	ST	105 105 1250				
Ford Transit										
60, 100, 115, 125 *69 *74	ZWP-5848	06.76>78	0039P 0018P	WP-013	PL	105 105 0900				
				WP-003	PP	105 105 1400				
				WP-117	TL	105 105 0750				
				WP-196	TP	105 105 1300				
				WP-035	SP	105 105 1100				
				WP-011	ST	105 105 2300				
				Ford Transit						
				60, 100, 115, 125 zacisk hamulca z dwoma tłoczkami two-piston brake caliper двухпоршневая скоба тормоза	ZWP-5849	01.78>85	0039P 0018P	WP-013	PL	105 105 0900
WP-003	PP	105 105 1400								
WP-117	TL	105 105 0750								
WP-027	TP	105 105 1250								
WP-019	SP	105 105 1000								
WP-011	ST	105 105 2300								
Ford Transit										
60, 100, 115, 125 zacisk hamulca z czterema tłoczkami four-piston brake caliper четырёхпоршневая скоба тормоза	ZWP-5850	>03.80	0039P 0018P					WP-041	ZPL	105 105 0350
				WP-041	ZPP	105 105 0350				
				WP-024	PL	105 105 0800				
				WP-013	PL+	105 105 0900				
				WP-047	PP	105 105 1500				
				WP-039	PP+	105 105 1550				
				WP-027	TL	105 105 1250				
				WP-024	TP	105 105 0800				
				WP-020	CC	105 105 3400				
				Ford Transit						
60, 100, 115, 125 zacisk hamulca z czterema tłoczkami four-piston brake caliper четырёхпоршневая скоба тормоза	ZWP-5851	04.80>85	0039P 0018P	WP-041	ZPL	105 105 0350				
				WP-041	ZPP	105 105 0350				
				WP-013	PL	105 105 0900				
				WP-013	PL+	105 105 0900				
				WP-047	PP	105 105 1500				
				WP-047	PP+	105 105 1500				
				WP-027	TL	105 105 1250				
				WP-024	TP	105 105 0800				
				WP-020	CC	105 105 3400				
				Ford Transit						
100 z naprzemianległym systemem hamulcowym with diagonal brake system с перекрёстной тормозной системой	ZWP-5852	86>91	0039P	WP-024	PL	105 105 0800				
				WP-010	PP	105 105 1850				
				WP-024	TL	105 105 0800				
				WP-047	TL	105 105 1500				
				WP-428	SP	105 105 2050				
				WP-210	ST	104 105 1550				
Ford Transit										
190 *74	ZWP-5853	73>85	0018P	WP-013	PL	105 105 0900				
				WP-003	PP	105 105 1400				
				WP-009	TL	105 105 0600				
				WP-115	TP	105 105 1150				
				WP-019	SP	105 105 1000				
				WP-167	ST	105 105 2600				

MARKA SAMOCHODU
CAR MODEL
МОДЕЛЬ АВТОМБИЯ

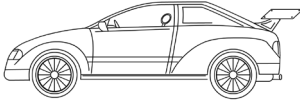

NUMER ZESTAWU
SET NUMBER
НОМЕР НАБОРА

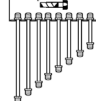

ROK PRODUKCJI
PRODUCTION YEAR
ГОД ВЫПУСКА АВТОМБИЯ



ODPOWIETRZNIK
BLEEDER SCREW
ШТУЦЕР ПРОКАЧКИ ТОРМОЗОВ

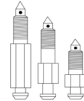

INDEKS
INDEX
ИНДЕКС



POŁOŻENIE
LOCATION
МЕСТО

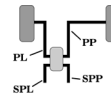

OPIS
DESCRIPTION
ОПИСАНИЕ

ZŁĄCZKA ZŁĄCZKA DŁUGOŚĆ
FITTING FITTING LENGTH
НАКОНЕЧНИК НАКОНЕЧНИК ДЛИНА

MARKA SAMOCHODU CAR MODEL МОДЕЛЬ АВТОМБИЯ	NUMER ZESTAWU SET NUMBER НОМЕР НАБОРА	ROK PRODUKCJI PRODUCTION YEAR ГОД ВЫПУСКА АВТОМБИЯ	ODPOWIETRZNIK BLEEDER SCREW ШТУЦЕР ПРОКАЧКИ ТОРМОЗОВ	INDEKS INDEX ИНДЕКС	POŁOŻENIE LOCATION МЕСТО	OPIS DESCRIPTION ОПИСАНИЕ
Ford Transit						
100 krótki model, bez ABS short model, without ABS короткая модель, без ABS	ZWP-5854	92>12.99	0039P	WP-024	PL	105 105 0800
				WP-023	PP	105 105 1800
				WP-002	TL	105 105 0850
				WP-034	TP	105 105 1200
				WP-520	SP	105 106 1950
				WP-435	CC	105 105 1600
			0053T	WP-197	ST	105 106 1750
Ford Transit						
100 długi model, bez ABS long model, without ABS длинная модель, без ABS	ZWP-5855	92>12.99	0039P	WP-117	PL	105 105 0750
				WP-428	PP	105 105 2050
				WP-024	TL	105 105 0800
				WP-027	TP	105 105 1250
				WP-529	SP	105 106 2800
				WP-034	CC	105 105 1200
			0053T	WP-1673	ST	105 106 2700
Ford Transit						
100 długi model, z ABS long model, with ABS длинная модель, с ABS	ZWP-5856	92>12.99	0039P	WP-023	PI	105 105 1800
				WP-006	PP	105 105 0250
				WP-117	TL	105 105 0750
				WP-034	TP	105 105 1200
				WP-002	SPL	105 105 0850
				WP-033	SPP	105 105 0700
				WP-112	CL	105 106 1550
				WP-194	CP	105 106 1400
				WP-456	STL	105 106 2600
			0053T	WP-456	STP	105 106 2600
Ford Transit						
Sredni model z ABS Mid model with ABS средний модели с ABS	ZWP-5857	01.00>		WP-108	PL	105 106 0400
				WP-440	PP	105 105 2150
				WP-033	TL	105 105 0700
				WP-047	TP	105 105 1500
				WP-448	SPL	105 106 0850
				WP-019	SPP	105 105 1000
				WP-715	CL	105 106 1800
				WP-197	CP	105 106 1750
				WP-023	STL	105 105 1800
				WP-023	STP	104 105 1800
Honda Accord						
Wszystkie modele All models Все модели	ZWP-5901	77>79	0017P	WP-218	PL	116 116 1800
				WP-131	PP	116 116 0700
				WP-118	TL	116 116 0300
				WP-118	TP	116 116 0300
				WP-822	CC	116 116 3050
			0015T	WP-569	CC+	116 116 4050
Honda Accord						
Wszystkie modele All models Все модели	ZWP-5902	80>81	0017P	WP-222	PL	116 116 1650
				WP-120	PP	116 116 0550
				WP-126	TL	116 116 0900
				WP-429	TL+	116 116 1000
				WP-251	TP	116 116 1600
				WP-218	TP+	116 116 1800
				WP-118	ZTL	116 116 0300
				WP-118	ZTP	116 116 0300
				WP-825	CC	116 116 3450
			0015T	WP-122	CC+	116 116 3700
Honda Accord						
SY 3-drzwi, 4-drzwi SY 3-door, 4-door SY 3-двери, 4-двери	ZWP-5903	82>83	0017P	WP-218	PL	116 116 1800
				WP-120	PP	116 116 0550
				WP-118	ZTL	116 116 0300
				WP-118	ZTP	116 116 0300
				WP-569	CL	116 116 4050
			0015T	WP-820	CP	116 116 2950
Honda Accord						
AC, AD 2-drzwi, 4-drzwi AC, AD 2-door, 4-door AC, AD 2-двери, 4-двери	ZWP-5904	84>85	0017P	WP-220	PL	116 116 1700
				WP-120	PP	116 116 0550
				WP-133	TL	116 116 1100
				WP-133	TL+	116 116 1100
				WP-223	TP	116 116 1550
				WP-218	TP+	116 116 1800
				WP-118	ZTL	116 116 0300
				WP-118	ZTP	116 116 0300
				WP-569	CL	116 116 4050
			0015T	WP-820	CP	116 116 2950
Honda Accord						
CA4, CA5 bez ABS CA4, CA5 without ABS CA4, CA5 без ABS	ZWP-5905	86>89	0017P	WP-222	PL	116 116 1650
				WP-134	PP	116 116 0500
				WP-118	ZTL	116 116 0300
				WP-118	ZTP	116 116 0300
			0101T	WP-219	CL	116 116 4100
			0015T	WP-820	CP	116 116 2950

*66

MARKA SAMOCHODU
CAR MODEL
МОДЕЛЬ АВТОМБИЯ

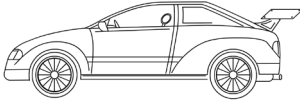

NUMER ZESTAWU
SET NUMBER
НОМЕР НАБОРА

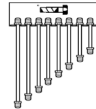

ROK PRODUKCJI
PRODUCTION YEAR
ГОД ВЫПУСКА АВТОМБИЯ



ODPOWIETRZNIK
BLEEDER SCREW
ШТУЦЕР ПРОКАЧКИ ТОРМОЗОВ

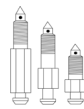

INDEKS
INDEX
ИНДЕКС



POŁOŻENIE
LOCATION
МЕСТО

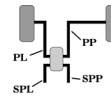

OPIS
DESCRIPTION
ОПИСАНИЕ

ZŁĄCZKA ZŁĄCZKA DŁUGOŚĆ
FITTING FITTING LENGTH
НАКОНЕЧНИК НАКОНЕЧНИК ДЛИНА

MARKA SAMOCHODU CAR MODEL МОДЕЛЬ АВТОМБИЯ	NUMER ZESTAWU SET NUMBER НОМЕР НАБОРА	ROK PRODUKCJI PRODUCTION YEAR ГОД ВЫПУСКА АВТОМБИЯ	ODPOWIETRZNIK BLEEDER SCREW ШТУЦЕР ПРОКАЧКИ ТОРМОЗОВ	INDEKS INDEX ИНДЕКС	POŁOŻENIE LOCATION МЕСТО	OPIS DESCRIPTION ОПИСАНИЕ
Honda Accord						
CA4, CA5 bez ABS CA4, CA5 without ABS CA4, CA5 без ABS	ZWP-5906	86>89	0017P	WP-222	PL	116 116 1650
				WP-134	PP	116 116 0500
				WP-144	TL	116 116 0400
				WP-144	TP	116 116 0400
				WP-118	ZTL	116 116 0300
				WP-118	ZTP	116 116 0300
				WP-219	CL	116 116 4100
				WP-820	CP	116 116 2950
*67			0101T 0015T			
Honda Accord						
1800 (CB1) bez ABS without ABS без ABS	ZWP-5907	90>91	0017P	WP-118	PL	116 116 0300
				WP-222	PP	116 116 1650
				WP-130	TL	116 116 0250
				WP-130	TP	116 116 0250
				WP-509	CL	116 116 2850
				WP-449	CP	116 116 3800
			0015T			
Honda Accord						
2000 (CB3) bez ABS without ABS без ABS	ZWP-5907	90>91	0017P	WP-118	PL	116 116 0300
				WP-222	PP	116 116 1650
				WP-130	TL	116 116 0250
				WP-130	TP	116 116 0250
				WP-509	CL	116 116 2850
				WP-449	CP	116 116 3800
			0011T 0101T			
Honda Accord						
2000 (CB3) bez ABS without ABS без ABS	ZWP-5907	92>93	0017P	WP-118	PL	116 116 0300
				WP-222	PP	116 116 1650
				WP-130	TL	116 116 0250
				WP-130	TP	116 116 0250
				WP-509	CL	116 116 2850
				WP-449	CP	116 116 3800
			0011T 0101T			
Honda Accord						
2000 (CB3), 2200 (CB7) bez ABS without ABS без ABS	ZWP-5907	92>93	0017P	WP-118	PL	116 116 0300
				WP-222	PP	116 116 1650
				WP-130	TL	116 116 0250
				WP-130	TP	116 116 0250
				WP-509	CL	116 116 2850
				WP-449	CP	116 116 3800
			0011T 0101T			
Honda Accord						
1.8 (CE7) z ABS with ABS c ABS	ZWP-5911	96>	0101P	WP-518	PL	104 116 1800
				WP-504	PP	104 116 0700
				WP-144	TL	116 116 0400
				WP-144	TP	116 116 0400
				WP-121	CL	116 116 2800
				WP-122	CP	116 116 3700
			0101T			
Honda Accord						
2.0 (CC7) bez ABS without ABS без ABS	ZWP-5912	93>96	0101P	WP-118	PL	116 116 0300
				WP-118	PP	116 116 0300
				WP-144	TL	116 116 0400
				WP-144	TP	116 116 0400
				WP-121	CL	116 116 2800
				WP-122	CP	116 116 3700
			0101T			
Honda Accord						
2.0 (CC7) z ABS with ABS c ABS	ZWP-5911	96>	0101P	WP-518	PL	104 116 1800
				WP-504	PP	104 116 0700
				WP-144	TL	116 116 0400
				WP-144	TP	116 116 0400
				WP-121	CL	116 116 2800
				WP-122	CP	116 116 3700
			0101T			
Honda Accord						
2.0 (CE8) bez ABS without ABS без ABS	ZWP-5912	93>96	0101P	WP-118	PL	116 116 0300
				WP-118	PP	116 116 0300
				WP-144	TL	116 116 0400
				WP-144	TP	116 116 0400
				WP-121	CL	116 116 2800
				WP-122	CP	116 116 3700
			0101T			
Honda Accord						
2.0 (CE8) z ABS with ABS c ABS	ZWP-5911	96>	0101P	WP-518	PL	104 116 1800
				WP-504	PP	104 116 0700
				WP-144	TL	116 116 0400
				WP-144	TP	116 116 0400
				WP-121	CL	116 116 2800
				WP-122	CP	116 116 3700
			0101T			
Honda Accord						
2.0 (CE9) z ABS z ABS with ABS c ABS	ZWP-5911	96>	0101P	WP-518	PL	104 116 1800
				WP-504	PP	104 116 0700
				WP-144	TL	116 116 0400
				WP-144	TP	116 116 0400
				WP-121	CL	116 116 2800
				WP-122	CP	116 116 3700
			0101T			

MARKA SAMOCHODU
CAR MODEL
МОДЕЛЬ АВТОМБИЯ

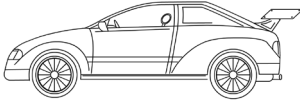

NUMER ZESTAWU
SET NUMBER
НОМЕР НАБОРА

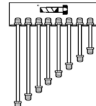

ROK PRODUKCJI
PRODUCTION YEAR
ГОД ВЫПУСКА АВТОМБИЯ



ODPOWIETRZNIK
BLEEDER SCREW
ШТУЦЕР ПРОКАЧКИ ТОРМОЗОВ

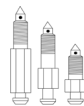

INDEKS
INDEX
ИНДЕКС



POŁOŻENIE
LOCATION
МЕСТО

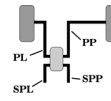

OPIS
DESCRIPTION
ОПИСАНИЕ

ZŁĄCZKA ZŁĄCZKA DŁUGOŚĆ
FITTING FITTING LENGTH
НАКОНЕЧНИК НАКОНЕЧНИК ДЛИНА

MARKA SAMOCHODU CAR MODEL МОДЕЛЬ АВТОМБИЯ	NUMER ZESTAWU SET NUMBER НОМЕР НАБОРА	ROK PRODUKCJI PRODUCTION YEAR ГОД ВЫПУСКА АВТОМБИЯ	ODPOWIETRZNIK BLEEDER SCREW ШТУЦЕР ПРОКАЧКИ ТОРМОЗОВ	INDEKS INDEX ИНДЕКС	POŁOŻENIE LOCATION МЕСТО	OPIS DESCRIPTION ОПИСАНИЕ
Honda Civic						
Wszystkie modele All models Все модели Nr 5045688	ZWP-5917	73>77	0017P	WP-130	ZPL	116 116 0250
				WP-130	ZPP	116 116 0250
				WP-120	PL	116 116 0550
				WP-131	PP	116 116 0700
				WP-135	TL	116 116 0150
				WP-135	TP	116 116 0150
				WP-143	CL	116 116 3300
				WP-127	CP	116 116 2600
Honda Civic						
Wszystkie modele All models Все модели Nr 5045689	ZWP-5918	77>78	0017P	WP-130	ZPL	116 116 0250
				WP-130	ZPP	116 116 0250
				WP-224	PL	116 116 1450
				WP-138	PP	116 116 0350
				WP-135	TL	116 116 0150
				WP-135	TP	116 116 0150
				WP-127	CL	116 116 2600
				WP-127	CP	116 116 2600
Honda Civic						
Wszystkie modele All models Все модели	ZWP-5919	79>	0017P	WP-130	ZPL	116 116 0250
				WP-130	ZPP	116 116 0250
				WP-224	PL	116 116 1450
				WP-138	PP	116 116 0350
				WP-135	TL	116 116 0150
				WP-135	TP	116 116 0150
				WP-127	CL	116 116 2600
				WP-221	CP	116 116 3500
Honda Civic						
Wszystkie modele All models Все модели	ZWP-5920	80>83	0017P	WP-140	PL	116 116 1500
				WP-138	PP	116 116 0350
				WP-118	ZTL	116 116 0300
				WP-118	ZTP	116 116 0300
				WP-509	CL	116 116 2850
				WP-225	CP	116 116 3900
				Honda Civic		
1.3, 1.5 2-drzwi 2-doors 2-двери	ZWP-5921	84>87	0017P	WP-140	PL	116 116 1500
				WP-138	PP	116 116 0350
				WP-118	ZTL	116 116 0300
				WP-118	ZTP	116 116 0300
				WP-127	CL	116 116 2600
				WP-449	CP	116 116 3800
Honda Civic						
1200 (EC7)	ZWP-5922	88>91	0017P	WP-144	PL	116 116 0400
				WP-251	PP	116 116 1600
				WP-118	TL	116 116 0300
				WP-118	TP	116 116 0300
				WP-449	CL	116 116 3800
				WP-820	CP	116 116 2950
Honda Civic						
1300 (EC8)	ZWP-5922	88>91	0017P	WP-144	PL	116 116 0400
				WP-251	PP	116 116 1600
				WP-118	TL	116 116 0300
				WP-118	TP	116 116 0300
				WP-449	CL	116 116 3800
				WP-820	CP	116 116 2950
Honda Civic						
1400 (EC9)	ZWP-5922	88>91	0017P	WP-144	PL	116 116 0400
				WP-251	PP	116 116 1600
				WP-118	TL	116 116 0300
				WP-118	TP	116 116 0300
				WP-449	CL	116 116 3800
				WP-820	CP	116 116 2950
Honda Civic						
1500 (ED6)	ZWP-5922	88>91	0017P	WP-114	PL	116 116 0400
				WP-251	PP	116 116 1600
				WP-118	TL	116 116 0300
				WP-118	TP	116 116 0300
				WP-449	CL	116 116 3800
				WP-820	CP	116 116 2950
Honda Civic						
1600 (ED7, EE9)	ZWP-5922	88>91	0017P	WP-114	PL	116 116 0400
				WP-251	PP	116 116 1600
				WP-118	TL	116 116 0300
				WP-118	TP	116 116 0300
				WP-449	CL	116 116 3800
				WP-820	CP	116 116 2950

MARKA SAMOCHODU
CAR MODEL
МОДЕЛЬ АВТОМБИЯ

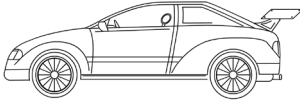

NUMER ZESTAWU
SET NUMBER
НОМЕР НАБОРА

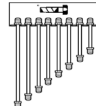

ROK PRODUKCJI
PRODUCTION YEAR
ГОД ВЫПУСКА АВТОМБИЯ



ODPOWIETRZNIK
BLEEDER SCREW
ШТУЦЕР ПРОКАЧКИ ТОРМОЗОВ

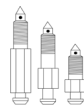

INDEKS
INDEX
ИНДЕКС



POŁOŻENIE
LOCATION
МЕСТО

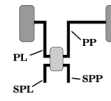

OPIS
DESCRIPTION
ОПИСАНИЕ

ZŁĄCZKA ZŁĄCZKA DŁUGOŚĆ
FITTING FITTING LENGTH
НАКОНЕЧНИК НАКОНЕЧНИК ДЛИНА

MARKA SAMOCHODU CAR MODEL МОДЕЛЬ АВТОМБИЯ	NUMER ZESTAWU SET NUMBER НОМЕР НАБОРА	ROK PRODUKCJI PRODUCTION YEAR ГОД ВЫПУСКА АВТОМБИЯ	ODPOWIETRZNIK BLEEDER SCREW ШТУЦЕР ПРОКАЧКИ ТОРМОЗОВ	INDEKS INDEX ИНДЕКС	POŁOŻENIE LOCATION МЕСТО	OPIS DESCRIPTION ОПИСАНИЕ
Honda Civic						
1300 (EG3) bez ABS without ABS без ABS	ZWP-5927	92>93	0017P	WP-429	PL	116 116 1000
				WP-136	PP	116 116 0850
				WP-118	TL	116 116 0300
				WP-118	TP	116 116 0300
				WP-122	CL	116 116 3700
*66			0100T	WP-143	CP	116 116 3300
Honda Civic						
1300 (EG3) bez ABS without ABS без ABS	ZWP-5928	94>95	0017P	WP-429	PL	116 116 1000
				WP-136	PP	116 116 0850
				WP-118	TL	116 116 0300
				WP-118	TP	116 116 0300
				WP-122	CL	116 116 3700
*66			0100T	WP-823	CP	116 116 3250
Honda Civic						
1500 (EG4) bez ABS without ABS без ABS	ZWP-5927	92>93	0017P	WP-429	PL	116 116 1000
				WP-136	PP	116 116 0850
				WP-118	TL	116 116 0300
				WP-118	TP	116 116 0300
				WP-122	CL	116 116 3700
*66			0100T	WP-143	CP	116 116 3300
Honda Civic						
1500 (EG4) bez ABS without ABS без ABS	ZWP-5928	94>95	0017P	WP-429	PL	116 116 1000
				WP-136	PP	116 116 0850
				WP-118	TL	116 116 0300
				WP-118	TP	116 116 0300
				WP-122	CL	116 116 3700
*66			0100T	WP-823	CP	116 116 3250
Honda Civic						
1500 (EG4)	ZWP-5931	92>93	0017P	WP-136	PL	116 116 0850
				WP-429	PP	116 116 1000
				WP-118	TL	116 116 0300
				WP-118	TP	116 116 0300
				WP-143	CL	116 116 3300
*66			0100T	WP-143	CP	116 116 3300
Honda Civic						
1600 (EG5, EG6) bez ABS without ABS без ABS	ZWP-5927	92>93	0017P	WP-429	PL	116 116 1000
				WP-136	PP	116 116 0850
				WP-118	TL	116 116 0300
				WP-118	TP	116 116 0300
				WP-122	CL	116 116 3700
*66			0100T	WP-143	CP	116 116 3300
Honda Civic						
1600 (EG9, EH1, EH9)	ZWP-5931	92>93	0017P	WP-136	PL	116 116 0850
				WP-429	PP	116 116 1000
				WP-118	TL	116 116 0300
				WP-118	TP	116 116 0300
				WP-143	CL	116 116 3300
*66			0100T	WP-143	CP	116 116 3300
Honda Civic						
1600 (EG5) bez ABS without ABS без ABS	ZWP-5928	94>95	0017P	WP-429	PL	116 116 1000
				WP-136	PP	116 116 0850
				WP-118	TL	116 116 0300
				WP-118	TP	116 116 0300
				WP-122	CL	116 116 3700
*66			0100T	WP-823	CP	116 116 3250
Honda Civic						
1.4i (MA8) bez ABS without ABS без ABS	ZWP-5935	95>	0017P	WP-136	PL	116 116 0850
				WP-136	PP	116 116 0850
				WP-138	TL	116 116 0350
				WP-138	TP	116 116 0350
				WP-821	CL	116 116 3000
			0100T	WP-567	CP	116 116 3550
Honda Civic						
1.4i (MA8) z ABS with ABS с ABS	ZWP-5936	95>	0017P	WP-809	PL	116 116 1150
				WP-120	PP	116 116 0550
				WP-821	CL	116 116 3000
				WP-221	CP	116 116 3500
Honda Civic						
1.5i (MA9) bez ABS without ABS без ABS	ZWP-5935	95>	0017P	WP-136	PL	116 116 0850
				WP-136	PP	116 116 0850
				WP-138	TL	116 116 0350
				WP-138	TP	116 116 0350
				WP-821	CL	116 116 3000
			0100T	WP-567	CP	116 116 3550

MARKA SAMOCHODU
CAR MODEL
МОДЕЛЬ АВТОМБИЯ

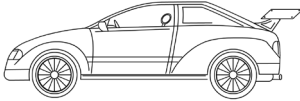

NUMER ZESTAWU
SET NUMBER
НОМЕР НАБОРА

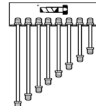

ROK PRODUKCJI
PRODUCTION YEAR
ГОД ВЫПУСКА АВТОМБИЯ



ODPOWIETRZNIK
BLEEDER SCREW
ШТУЦЕР ПРОКАЧКИ ТОРМОЗОВ

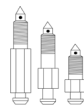

INDEKS
INDEX
ИНДЕКС



POŁOŻENIE
LOCATION
МЕСТО

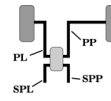

OPIS
DESCRIPTION
ОПИСАНИЕ

ZŁĄCZKA ZŁĄCZKA DŁUGOŚĆ
FITTING FITTING LENGTH
НАКОНЕЧНИК НАКОНЕЧНИК ДЛИНА

MARKA SAMOCHODU CAR MODEL МОДЕЛЬ АВТОМБИЯ	NUMER ZESTAWU SET NUMBER НОМЕР НАБОРА	ROK PRODUKCJI PRODUCTION YEAR ГОД ВЫПУСКА АВТОМБИЯ	ODPOWIETRZNIK BLEEDER SCREW ШТУЦЕР ПРОКАЧКИ ТОРМОЗОВ	INDEKS INDEX ИНДЕКС	POŁOŻENIE LOCATION МЕСТО	OPIS DESCRIPTION ОПИСАНИЕ
Honda Civic						
1.4i (MB2) bez ABS without ABS без ABS	ZWP-5935	95>	0017P	WP-136	PL	116 116 0850
				WP-136	PP	116 116 0850
				WP-138	TL	116 116 0350
				WP-138	TP	116 116 0350
				WP-821	CL	116 116 3000
			0100T	WP-567	CP	116 116 3550
Honda Civic						
1.5i (MB3) bez ABS without ABS без ABS	ZWP-5935	95>	0017P	WP-136	PL	116 116 0850
				WP-136	PP	116 116 0850
				WP-138	TL	116 116 0350
				WP-138	TP	116 116 0350
				WP-821	CL	116 116 3000
			0100T	WP-567	CP	116 116 3550
Honda Civic						
1.5i (MA9) z ABS with ABS с ABS	ZWP-5936	95>	0017P	WP-809	PL	116 116 1150
				WP-120	PP	116 116 0550
				WP-821	CL	116 116 3000
				WP-221	CP	116 116 3500
Honda Civic						
1.6iLS, 1.6iSR, 1.6iES (MB1) z ABS with ABS с ABS	ZWP-5936	95>	0017P	WP-809	PL	116 116 1150
				WP-120	PP	116 116 0550
				WP-821	CL	116 116 3000
				WP-221	CP	116 116 3500
Honda Civic						
1.4iS (EJ9) bez ABS without ABS без ABS	ZWP-5942	96>97	0017P	WP-126	PL	116 116 0900
				WP-133	PP	116 116 1100
				WP-118	TL	116 116 0300
				WP-118	TP	116 116 0300
				WP-823	CL	116 116 3250
			0100T	WP-122	CP	116 116 3700
Honda Civic						
1.4iS (EJ9) z ABS with ABS с ABS	ZWP-5943	96>97	0017P	WP-124	PL	116 116 1350
				WP-144	PP	116 116 0400
				WP-118	TL	116 116 0300
				WP-118	TP	116 116 0300
				WP-823	CL	116 116 3250
			0100T	WP-122	CP	116 116 3700
Honda Civic						
1.4i (MA8) bez ABS without ABS без ABS	ZWP-5944	96>97	0017P	WP-136	PL	116 116 0850
				WP-126	PP	116 116 0900
				WP-354	TL	105 116 0350
				WP-354	TP	105 116 0350
				WP-821	CL	116 116 3000
			0100T	WP-567	CP	116 116 3550
Honda Civic						
1.4i (MA8) z ABS with ABS с ABS	ZWP-5945	96>	0017P	WP-704	PL	104 116 1500
				WP-703	PP	104 116 0450
				WP-821	CL	116 116 3000
				WP-567	CP	116 116 3550
Honda Civic						
1.4i (MA8) z ABS with ABS с ABS	ZWP-5946	97>	0017P	WP-743	PL	105 116 1250
				WP-736	PP	105 116 0500
				WP-821	CL	116 116 3000
				WP-567	CP	116 116 3550
Honda Civic						
1.4i (MB2) bez ABS without ABS без ABS	ZWP-5944	96>97	0017P	WP-136	PL	116 116 0850
				WP-126	PP	116 116 0900
				WP-354	TL	105 116 0350
				WP-354	TP	105 116 0350
				WP-821	CL	116 116 3000
			0100T	WP-567	CP	116 116 3550
Honda Civic						
1.5i (MA9) bez ABS without ABS без ABS	ZWP-5944	96>97	0017P	WP-136	PL	116 116 0850
				WP-126	PP	116 116 0900
				WP-354	TL	105 116 0350
				WP-354	TP	105 116 0350
				WP-821	CL	116 116 3000
			0100T	WP-567	CP	116 116 3550
Honda Civic						
1.5i (MB3) bez ABS without ABS без ABS	ZWP-5944	96>97	0017P	WP-136	PL	116 116 0850
				WP-126	PP	116 116 0900
				WP-354	TL	105 116 0350
				WP-354	TP	105 116 0350
				WP-821	CL	116 116 3000
			0100T	WP-567	CP	116 116 3550

MARKA SAMOCHODU
CAR MODEL
МОДЕЛЬ АВТОМБИЯ

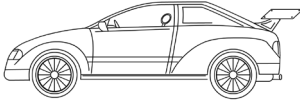

NUMER ZESTAWU
SET NUMBER
НОМЕР НАБОРА

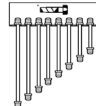

ROK PRODUKCJI
PRODUCTION YEAR
ГОД ВЫПУСКА АВТОМБИЯ



ODPOWIETRZNIK
BLEEDER SCREW
ШТУЦЕР ПРОКАЧКИ ТОРМОЗОВ

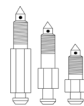

INDEKS
INDEX
ИНДЕКС



POŁOŻENIE
LOCATION
МЕСТО

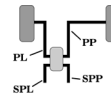

OPIS
DESCRIPTION
ОПИСАНИЕ

ZŁĄCZKA ZŁĄCZKA DŁUGOŚĆ
FITTING FITTING LENGTH
НАКОНЕЧНИК НАКОНЕЧНИК ДЛИНА

MARKA SAMOCHODU CAR MODEL МОДЕЛЬ АВТОМБИЯ	NUMER ZESTAWU SET NUMBER НОМЕР НАБОРА	ROK PRODUKCJI PRODUCTION YEAR ГОД ВЫПУСКА АВТОМБИЯ	ODPOWIETRZNIK BLEEDER SCREW ШТУЦЕР ПРОКАЧКИ ТОРМОЗОВ	INDEKS INDEX ИНДЕКС	POŁOŻENIE LOCATION МЕСТО	OPIS DESCRIPTION ОПИСАНИЕ
Honda Civic						
1.5iLS (EK3) z ABS with ABS c ABS	ZWP-5943	96>97	0017P	WP-124	PL	116 116 1350
				WP-144	PP	116 116 0400
				WP-118	TL	116 116 0300
				WP-118	TP	116 116 0300
				WP-823	CL	116 116 3250
			0100T	WP-122	CP	116 116 3700
Honda Civic						
1.5iLS (EK3) bez ABS without ABS без ABS	ZWP-5942	96>97	0017P	WP-126	PL	116 116 0900
				WP-133	PP	116 116 1100
				WP-118	TL	116 116 0300
				WP-118	TP	116 116 0300
				WP-823	CL	116 116 3250
			0100T	WP-122	CP	116 116 3700
Honda Civic						
1.5i (MA9) z ABS with ABS c ABS	ZWP-5945	96>	0017P	WP-704	PL	104 116 1500
				WP-703	PP	104 116 0450
				WP-821	CL	116 116 3000
				WP-567	CP	116 116 3550
Honda Civic						
1.5i (MA9) z ABS with ABS c ABS	ZWP-5946	97>	0017P	WP-743	PL	105 116 1250
				WP-736	PP	105 116 0500
				WP-821	CL	116 116 3000
				WP-567	CP	116 116 3550
Honda Civic						
1.6VTi (EK1) z ABS with ABS c ABS	ZWP-5943	96>97	0017P	WP-124	PL	116 116 1350
				WP-144	PP	116 116 0400
				WP-118	TL	116 116 0300
				WP-118	TP	116 116 0300
				WP-823	CL	116 116 3250
			0100T	WP-122	CP	116 116 3700
Honda Civic						
1.6iLS, 1.6iSR (MB1) z ABS with ABS c ABS	ZWP-5945	96>	0017P	WP-704	PL	104 116 1500
				WP-703	PP	104 116 0450
				WP-821	CL	116 116 3000
				WP-567	CP	116 116 3550
Honda Civic						
1.6iLS, 1.6iSR (MB1) z ABS with ABS c ABS	ZWP-5946	97>	0017P	WP-743	PL	105 116 1250
				WP-736	PP	105 116 0500
				WP-821	CL	116 116 3000
				WP-567	CP	116 116 3550
Honda Civic						
1.8VTi (MB6) z ABS with ABS c ABS	ZWP-5946	97>	0017P	WP-743	PL	105 116 1250
				WP-736	PP	105 116 0500
				WP-821	CL	116 116 3000
				WP-567	CP	116 116 3550
CR-V II						
2.0 + ABS	ZWP-5958	07.02>		WP-1861	PL	105 105X 2700
				WP-556	PP	105 105X 0700
				WP-004	CL	105 105 3100
				WP-030	CP	105 105 3700
CR-V II						
2.2 i-CTDi + ABS	ZWP-5959	02.05>		WP-167	PL	105 105 2600
				WP-024	PP	105 105 0800
				WP-004	CL	105 105 3100
				WP-030	CP	105 105 3700
Hyundai Accent						
Wszystkie modele, bez ABS All models, without ABS Все модели, без ABS	ZWP-6001	07.94>12.99	0017P	WP-141	PL	116 116 0600
				WP-581	PP	116 116 1400
				WP-135	TL	116 116 0150
				WP-135	TP	116 116 0150
				WP-355	SPL	105 116 1150
				WP-351	SPP	105 116 1450
				WP-530	STL	105 116 3250
				WP-527	STP	105 116 2150
			0107T			
Hyundai Accent						
Wszystkie modele, z ABS All models, with ABS Все модели, с ABS	ZWP-6002	07.94>02.99	0017P	WP-817	PL	116 116 2350
				WP-136	PP	116 116 0850
				WP-135	TL	116 116 0150
				WP-135	TP	116 116 0150
				WP-346	SPL	105 116 0900
				WP-515	SPP	105 116 0750
				WP-530	STL	105 116 3250
				WP-527	STP	105 116 2150
			0107T			
Hyundai Accent						
Wszystkie modele, z ABS All models, with ABS Все модели, с ABS	ZWP-6003	01.00>		WP-018	PL	105 105 0650
				WP-047	PP	105 105 1500
				WP-043	TL	105 105 0200
				WP-043	TP	105 105 0200
				WP-433	CL	105 105 2950
				WP-031	CP	105 105 2200

MARKA SAMOCHODU
CAR MODEL
МОДЕЛЬ АВТОМБИЯ

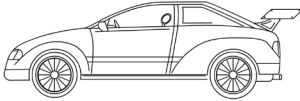

NUMER ZESTAWU
SET NUMBER
НОМЕР НАБОРА

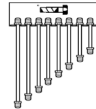

ROK PRODUKCJI
PRODUCTION YEAR
ГОД ВЫПУСКА АВТОМБИЯ



ODPOWIETRZNIK
BLEEDER SCREW
ШТУЦЕР ПРОКАЧКИ ТОРМОЗОВ

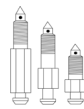

INDEKS
INDEX
ИНДЕКС



POŁOŻENIE
LOCATION
МЕСТО

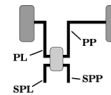

OPIS
DESCRIPTION
ОПИСАНИЕ

ZŁĄCZKA
FITTING
НАКОНЕЧНИК

ZŁĄCZKA
FITTING
НАКОНЕЧНИК

DŁUGOŚĆ
LENGTH
ДЛИНА

MARKA SAMOCHODU CAR MODEL МОДЕЛЬ АВТОМБИЯ	NUMER ZESTAWU SET NUMBER НОМЕР НАБОРА	ROK PRODUKCJI PRODUCTION YEAR ГОД ВЫПУСКА АВТОМБИЯ	ODPOWIETRZNIK BLEEDER SCREW ШТУЦЕР ПРОКАЧКИ ТОРМОЗОВ	INDEKS INDEX ИНДЕКС	POŁOŻENIE LOCATION МЕСТО	OPIS DESCRIPTION ОПИСАНИЕ
Hyundai Elentra						
Wszystkie modele All models Все модели *67	ZWP-6011	11.95>09.00	0039T	WP-1732	PL	105 116 2500
				WP-738	PP	105 116 0700
				WP-122	CL	116 116 3700
				WP-820	CP	116 116 2950
Hyundai Excel						
Wszystkie modele All models Все модели	ZWP-6001	07.94>12.99	0017P	WP-141	PL	116 116 0600
				WP-581	PP	116 116 1400
				WP-135	TL	116 116 0150
				WP-135	TP	116 116 0150
				WP-355	SPL	105 116 1150
				WP-351	SPP	105 116 1450
				WP-530	STL	105 116 3250
				WP-527	STP	105 116 2150
Hyundai Excel						
Wszystkie modele, z ABS All models, with ABS Все модели, с ABS	ZWP-6002	07.94>12.99	0017P	WP-817	PL	116 116 2350
				WP-136	PP	116 116 0850
				WP-135	TL	116 116 0150
				WP-135	TP	116 116 0150
				WP-346	SPL	105 116 0900
				WP-515	SPP	105 116 0750
				WP-530	STL	105 116 3250
			0107T	WP-527	STP	105 116 2150
Hyundai Excel						
Wszystkie modele, z ABS All models, with ABS Все модели, с ABS	ZWP-6003	01.00>	0017P	WP-018	PL	105 105 0650
				WP-047	PP	105 105 1500
				WP-043	TL	105 105 0200
				WP-043	TP	105 105 0200
				WP-433	CL	105 105 2950
			0107T	WP-031	CP	105 105 2200
Hyundai Getz						
Wszystkie modele, z ABS All models, with ABS Все модели, с ABS	ZWP-6012	09.02>		WP-001	PL	105 105 0300
				WP-035	PP	105 105 1100
				WP-017	SPL	105 105 0500
				WP-017	SPP	105 105 0500
				WP-559	CL	105 105 2350
				WP-533	CP	105 105 2750
				WP-028	TL	105 105 0550
				WP-252	TP	105 105 1050
Hyundai H-1						
Wszystkie modele, z ABS All models, with ABS Все модели, с ABS	ZWP-6013	02.02>		WP-032	PL	105 105 2800
				WP-011	PP	105 105 2300
				WP-027	SPL	105 105 1250
				WP-034	SPP	105 105 1200
				WP-040	CL	105 105 3300
				WP-046	CP	105 105 3500
				WP-024	SPL	105 105 0800
				WP-028	SPP	105 105 0550
				WP-1743	TL	105 105S 0650
				WP-1744	TP	105 105S 1300
Hyundai Lantra II						
Wszystkie modele All models Все модели *67	ZWP-6011	11.95>09.00		WP-1732	PL	105 116 2500
				WP-738	PP	105 116 0700
				WP-122	CL	116 116 3700
				WP-820	CP	116 116 2950
Hyundai Matrix						
Wszystkie modele All models Все модели	ZWP-6015	06.01>		WP-024	PL	105 105 0800
				WP-435	PP	105 105 1600
				WP-018	SPL	105 105 0650
				WP-018	SPP	105 105 0650
				WP-706	CL	105 105 2450
				WP-008	CP	105 105 3000
				WP-043	TL	105 105 0200
				WP-043	TP	105 105 0200
Hyundai Pony						
Wszystkie modele, bez ABS All models, without ABS Все модели, без ABS	ZWP-6001	07.94>12.99	0017P	WP-141	PL	116 116 0600
				WP-581	PP	116 116 1400
				WP-135	TL	116 116 0150
				WP-135	TP	116 116 0150
				WP-355	SPL	105 116 1150
				WP-351	SPP	105 116 1450
				WP-530	STL	105 116 3250
			0107T	WP-527	STP	105 116 2150
Hyundai Pony						
Wszystkie modele, z ABS All models, with ABS Все модели, с ABS	ZWP-6002	07.94>02.97	0017P	WP-817	PL	116 116 2350
				WP-136	PP	116 116 0850
				WP-135	TL	116 116 0150
				WP-135	TP	116 116 0150
				WP-346	SPL	105 116 0900
				WP-515	SPP	105 116 0750
				WP-530	STL	105 116 3250
			0107T	WP-527	STP	105 116 2150

MARKA SAMOCHODU
CAR MODEL
МОДЕЛЬ АВТОМБИЯ

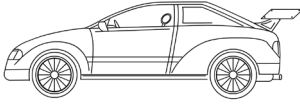

NUMER ZESTAWU
SET NUMBER
НОМЕР НАБОРА

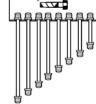

ROK PRODUKCJI
PRODUCTION YEAR
ГОД ВЫПУСКА АВТОМБИЯ



ODPOWIETRZNIK
BLEEDER SCREW
ШТУЦЕР ПРОКАЧКИ ТОРМОЗОВ

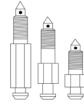

INDEKS
INDEX
ИНДЕКС



POŁOŻENIE
LOCATION
МЕСТО

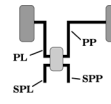

OPIS
DESCRIPTION
ОПИСАНИЕ

ZŁĄCZKA
FITTING
НАКОНЕЧНИК

ZŁĄCZKA
FITTING
НАКОНЕЧНИК

DŁUGOŚĆ
LENGTH
ДЛИНА

MARKA SAMOCHODU CAR MODEL МОДЕЛЬ АВТОМБИЯ	NUMER ZESTAWU SET NUMBER НОМЕР НАБОРА	ROK PRODUKCJI PRODUCTION YEAR ГОД ВЫПУСКА АВТОМБИЯ	ODPOWIETRZNIK BLEEDER SCREW ШТУЦЕР ПРОКАЧКИ ТОРМОЗОВ	INDEKS INDEX ИНДЕКС	POŁOŻENIE LOCATION МЕСТО	OPIS DESCRIPTION ОПИСАНИЕ				
Hyundai Pony										
Wszystkie modele, z ABS All models, with ABS Все модели, с ABS	ZWP-6003	01.00>	0017P	WP-018	PL	105 105 0650				
				WP-047	PP	105 105 1500				
				WP-433	CL	105 105 2950				
				WP-031	CP	105 105 2200				
				WP-043	TL	105 105 0200				
			0107T	WP-043	TP	105 105 0200				
Hyundai Santa Fe										
Wszystkie modele, z ABS All models, with ABS Все модели, с ABS	ZWP-6010	02.01>	0017P	WP-002	PL	105 105 0850				
				WP-013	PP	105 105 0900				
				WP-035	SPL	105 105 1100				
				WP-252	SPP	105 105 1050				
				WP-390	CL	105 105 2250				
			0107T	WP-029	CP	105 105 3200				
Isuzu Campo (TFR)										
Wszystkie modele All models Все модели	ZWP-6101	88>09.92		WP-126	PL	116 116 0900				
				WP-120	PP	116 116 0550				
				WP-132	TL	116 116 1050				
				WP-120	TP	116 116 0550				
				WP-824	CC	116 116 3350				
Isuzu Campo (TFR)										
2.2, 2.3, 2.5, 3.1	ZWP-6101	10.92>06.94		WP-126	PL	116 116 0900				
				WP-120	PP	116 116 0550				
				WP-132	TL	116 116 1050				
				WP-120	TP	116 116 0550				
				WP-824	CC	116 116 3350				
Isuzu Campo (TFR)										
2.3, 2.5	ZWP-6101	07.94>		WP-126	PL	116 116 0900				
				WP-120	PP	116 116 0550				
				WP-132	TL	116 116 1050				
				WP-120	TP	116 116 0550				
				WP-824	CC	116 116 3350				
Isuzu Campo (TFR)										
3.1	ZWP-6101	07.94>		WP-126	PL	116 116 0900				
				WP-120	PP	116 116 0500				
				WP-132	TL	116 116 1050				
				WP-120	TP	116 116 0550				
				WP-824	CC	116 116 3350				
KIA Carnival II										
	ZWP-6203	10.01>		WP-1745	PL	105 105X 0550				
				WP-023	PP	105 105 1800				
				WP-253	CL	105 105 4200				
				WP-050	CP	105 105 4100				
				WP-1876	TL	105X 116 1200				
				WP-1877	TP	105X 116 1250				
KIA Picanto										
Wszystkie modele, z ABS All models, with ABS Все модели, с ABS	ZWP-6204	04.04>		WP-027	PL	105 105 1250				
				WP-196	PP	105 105 1300				
				WP-036	CL	105 105 2100				
				WP-029	CP	105 105 3200				
KIA Sorento										
Wszystkie modele, z ABS All models, with ABS Все модели, с ABS	ZWP-6205	08.02>		WP-049	PL	105 105 1900				
				WP-042	PP	105 105 1700				
				WP-024	SPL	105 105 0800				
				WP-033	SPP	105 105 0700				
				WP-029	CL	105 105 3200				
				WP-008	CP	105 105 3000				
				WP-013	TL	105 105 0900				
				WP-018	TP	105 105 0650				
Kia Sephia/Shuma										
	ZWP-6202	10.97>	0100P	WP-025	CL	105 105 4300				
				WP-040	CP	105 105 3300				
				WP-703	POM-ABS	104 116 0450				
				WP-1082	POM-ABS	104 116 0410				
				WP-1082	PL	104 116 0410				
				WP-738	PP	105 116 0700				
				WP-739	ABS	105 116 0850				
				WP-504	TL	104 116 0700				
				WP-906	TP	105 116 0600				
							0039T			
				LANCIA A112						
Wszystkie modele All models Все модели	ZWP-6301	80>06.86	0100P	WP-053	PL	112 112 0500				
				WP-052	PP	112 112 1050				
				WP-228	TL	112 112 0750				
				WP-160	TP	112 112 1150				
				WP-055	SP	112 112 2100				
			0100T	WP-229	ST	112 112 0250				

MARKA SAMOCHODU
CAR MODEL
МОДЕЛЬ АВТОМБИЯ

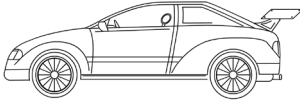

NUMER ZESTAWU
SET NUMBER
НОМЕР НАБОРА

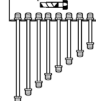

ROK PRODUKCJI
PRODUCTION YEAR
ГОД ВЫПУСКА АВТОМБИЯ



ODPOWIETRZNIK
BLEEDER SCREW
ШТУЦЕР ПРОКАЧКИ ТОРМОЗОВ

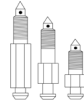

INDEKS
INDEX
ИНДЕКС



POŁOŻENIE
LOCATION
МЕСТО

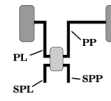

OPIS
DESCRIPTION
ОПИСАНИЕ

ZŁĄCZKA ZŁĄCZKA DŁUGOŚĆ
FITTING FITTING LENGTH
НАКОНЕЧНИК НАКОНЕЧНИК ДЛИНА

LUBLIN							
	ZWP-6402			WP-356	POM-ŁĄCZ P	105 105 1450	
				WP-356	POM-ŁĄCZ T	105 105 1450	
				WP-734	KOST-TRÓJ	105 112 2250	
				WP-265	KOST-RED	105 105 0950	
				WP-022	PL	105 105 1350	
				WP-022	PP	105 105 1350	
				WP-009	TL	105 105 0600	
				WP-027	TP	105 105 1250	
				WP-465	KOR	105 112 0150	
ŁADA 1200							
Wszystkie modele All models Все модели	ZWP-8801	72>89	0100P	WP-056	ZPL	112 112 0300	
				WP-056	ZPP	112 112 0300	
				WP-053	PL	112 112 0500	
				WP-165	PP	112 112 1400	
				WP-051	TL	112 112 0550	
				WP-154	TP	112 112 0950	
				WP-421	KOR-TRÓJ	112 112 1200	
			0100T	WP-155	CC	112 112 3500	
ŁADA 1300							
Wszystkie modele All models Все модели	ZWP-8801	74>77	0100P	WP-056	ZPL	112 112 0300	
				WP-056	ZPP	112 112 0300	
				WP-053	PL	112 112 0500	
				WP-165	PP	112 112 1400	
				WP-051	TL	112 112 0550	
				WP-154	TP	112 112 0950	
				WP-421	KOR-TRÓJ	112 112 1200	
			0100T	WP-155	CC	112 112 3500	
ŁADA 1300							
Wszystkie modele All models Все модели	ZWP-8802	78>83	0100P	WP-056	ZPL	112 112 0300	
				WP-056	ZPP	112 112 0300	
				WP-051	PL	112 112 0550	
				WP-165	PP	112 112 1400	
				WP-051	TL	112 112 0550	
				WP-154	TP	112 112 0950	
				WP-421	KOR-TRÓJ	112 112 1200	
			0100T	WP-155	CC	112 112 3500	
ŁADA 1500							
Wszystkie modele All models Все модели	ZWP-8802	75>87	0100P	WP-056	ZPL	112 112 0300	
				WP-056	ZPP	112 112 0300	
				WP-051	PL	112 112 0550	
				WP-165	PP	112 112 1400	
				WP-051	TL	112 112 0550	
				WP-154	TP	112 112 0950	
				WP-421	KOR-TRÓJ	112 112 1200	
			0100T	WP-155	CC	112 112 3500	
ŁADA 1600							
Wszystkie modele All models Все модели	ZWP-8802	75>87	0100P	WP-056	ZPL	112 112 0300	
				WP-056	ZPP	112 112 0300	
				WP-051	PL	112 112 0550	
				WP-165	PP	112 112 1400	
				WP-051	TL	112 112 0550	
				WP-154	TP	112 112 0950	
				WP-421	KOR-TRÓJ	112 112 1200	
			0100T	WP-155	CC	112 112 3500	
ŁADA NIVA							
	ZWP-8803	79>		WP-051	PL	112 112 0550	
				WP-054	PP	112 112 0900	
				WP-154	TL	112 112 0950	
				WP-154	TP	112 112 0950	
				WP-157	SP	112 112 3000	
				WP-152	ST	112 112 1250	
ŁADA SAMARA							
Wszystkie modele All models Все модели	ZWP-8804	03.85>	0100P	WP-051	PL	112 112 0550	
				WP-168	PP	112 112 1600	
				WP-056	TL	112 112 0300	
				WP-227	TP	112 112 1850	
				WP-411	ZTL	112 112 0800	
				WP-411	ZTP	112 112 0800	
				WP-166	CL	112 112 3300	
			0100T	WP-226	CP	112 112 3100	
Mazda 121							
DB	ZWP-6501	11.90>01.96	0090P	WP-136	PL	116 116 0850	
				WP-136	PP	116 116 0850	
				WP-431	TL	116 116 0650	
				WP-120	TP	116 116 0550	
				WP-823	CL	116 116 3250	
				WP-817	SPP	116 116 2350	
			0089T	WP-224	STP	116 116 1450	

MARKA SAMOCHODU
CAR MODEL
МОДЕЛЬ АВТОМБИЯ

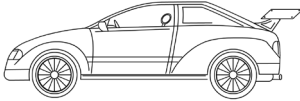

NUMER ZESTAWU
SET NUMBER
НОМЕР НАБОРА

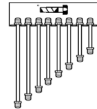

ROK PRODUKCJI
PRODUCTION YEAR
ГОД ВЫПУСКА АВТОМБИЯ



ODPOWIETRNIK
BLEEDER SCREW
ШТУЦЕР ПРОКАЧКИ ТОРМОЗОВ

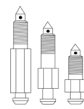

INDEKS
INDEX
ИНДЕКС



POŁOŻENIE
LOCATION
МЕСТО

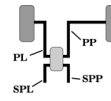

OPIS
DESCRIPTION
ОПИСАНИЕ

ZŁĄCZKA
FITTING
НАКОНЕЧНИК

ZŁĄCZKA
FITTING
НАКОНЕЧНИК

DŁUGOŚĆ
LENGTH
ДЛИНА

MARKA SAMOCHODU CAR MODEL МОДЕЛЬ АВТОМБИЯ	NUMER ZESTAWU SET NUMBER НОМЕР НАБОРА	ROK PRODUKCJI PRODUCTION YEAR ГОД ВЫПУСКА АВТОМБИЯ	ODPOWIETRNIK BLEEDER SCREW ШТУЦЕР ПРОКАЧКИ ТОРМОЗОВ	INDEKS INDEX ИНДЕКС	POŁOŻENIE LOCATION МЕСТО	OPIS DESCRIPTION ОПИСАНИЕ
Mazda 6						
Wszystkie modele, benzyna, bez DSC All models, petrol, without DSC Все модели, бензин, без DSC	ZWP-6545	08.02>		WP-141	PL	116 116 0600
				WP-220	PP	116 116 1700
				WP-143	CL	116 116 3300
				WP-827	CP	116 116 4300
Mazda 6						
Wszystkie modele, benzyna, z DSC All models, petrol, with DSC Все модели, бензин, с DSC	ZWP-6546	08.02>		WP-131	PL	116 116 0700
				WP-218	PP	116 116 1800
				WP-823	CL	116 116 3250
				WP-1737	CP	116 116 4350
Mazda 6						
Wszystkie modele, diesel, bez DSC All models, diesel, without DSC Все модели, diesel, без DSC	ZWP-6546	08.02>		WP-141	PL	116 116 0600
				WP-223	PP	116 116 1550
				WP-143	CL	116 116 3300
				WP-827	CP	116 116 4300
Mazda 6						
Wszystkie modele, diesel, z DSC All models, diesel, with DSC Все модели, diesel, с DSC	ZWP-6547	08.02>		WP-131	PL	116 116 0700
				WP-222	PP	116 116 1650
				WP-823	CL	116 116 3250
				WP-1737	CP	116 116 4350
Mazda 323						
BD napęd przedni front-wheel drive передний привод	ZWP-6502	11.80>04.85	0090P	WP-126	PL	116 116 0900
				WP-124	PP	116 116 1350
				WP-144	TL	116 116 0400
				WP-131	TP	116 116 0700
				WP-130	ZTL	116 116 0250
				WP-130	ZTP	116 116 0250
				WP-122	CL	116 116 3700
				WP-122	CP	116 116 3700
				0089T		
				0089T		
Mazda 323						
BF Hetchback, Sedan	ZWP-6503	05.85>03.87	0090P	WP-129	PL	116 116 1200
				WP-126	PP	116 116 0900
				WP-125	TL	116 116 0750
				WP-144	TP	116 116 0400
				WP-130	ZTL	116 116 0250
				WP-130	ZTP	116 116 0250
				WP-567	CL	116 116 3550
				WP-567	CP	116 116 3550
				0069T		
				0069T		
Mazda 323						
BF Hetchback, Sedan	ZWP-6504	04.87>05.89	0090P	WP-129	PL	116 116 1200
				WP-126	PP	116 116 0900
				WP-125	TL	116 116 0750
				WP-144	TP	116 116 0400
				WP-070	ZTL	116 116 0200
				WP-070	ZTP	116 116 0200
				WP-122	CL	116 116 3700
				WP-122	CP	116 116 3700
				0069T		
				0069T		
Mazda 323						
BG 2WD *66	ZWP-6505	03.91>05.94	0090P	WP-133	PL	116 116 1100
				WP-132	PP	116 116 1050
				WP-136	TL	116 116 0850
				WP-120	TP	116 116 0550
				WP-118	ZTL	116 116 0300
				WP-118	ZTP	116 116 0300
				WP-122	CL	116 116 3700
				WP-449	CP	116 116 3800
				0089T		
				0089T		
Mazda 323						
BG 2WD *67	ZWP-6506	03.91>05.94	0090P	WP-136	PL	116 116 0850
				WP-222	PP	116 116 1650
				WP-136	TL	116 116 0850
				WP-120	TP	116 116 0550
				WP-131	CL	116 116 3700
				WP-449	CP	116 116 3800
				0089T		
0089T						
Mazda 323						
BW Wagon *66	ZWP-6507	01.86>06.95	0090P	WP-129	PL	116 116 1200
				WP-126	PP	116 116 0900
				WP-144	TL	116 116 0400
				WP-141	TP	116 116 0600
				WP-070	ZTL	116 116 0200
				WP-070	ZTP	116 116 0200
				WP-449	CL	116 116 3800
				WP-449	CP	116 116 3800
				0089T		
				0089T		
Mazda 323						
FA Sedan	ZWP-6508	77>11.80	0086P	WP-230	PL	113 113 0700
				WP-213	PP	113 113 1100
				WP-233	TL	113 113 0850
				WP-234	TP	113 113 0550
				WP-232	CC	113 113 3000
0090T						

MARKA SAMOCHODU
CAR MODEL
МОДЕЛЬ АВТОМБИЯ

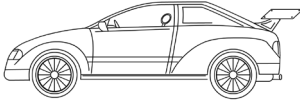

NUMER ZESTAWU
SET NUMBER
НОМЕР НАБОРА

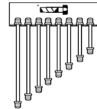

ROK PRODUKCJI
PRODUCTION YEAR
ГОД ВЫПУСКА АВТОМБИЯ



ODPOWIETRNIK
BLEEDER SCREW
ШТУЦЕР ПРОКАЧКИ ТОРМОЗОВ

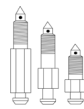

INDEKS
INDEX
ИНДЕКС



POŁOŻENIE
LOCATION
МЕСТО

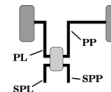

OPIS
DESCRIPTION
ОПИСАНИЕ

ZŁĄCZKA ZŁĄCZKA DŁUGOŚĆ
FITTING FITTING LENGTH
НАКОНЕЧНИК НАКОНЕЧНИК ДЛИНА

MARKA SAMOCHODU CAR MODEL МОДЕЛЬ АВТОМБИЯ	NUMER ZESTAWU SET NUMBER НОМЕР НАБОРА	ROK PRODUKCJI PRODUCTION YEAR ГОД ВЫПУСКА АВТОМБИЯ	ODPOWIETRNIK BLEEDER SCREW ШТУЦЕР ПРОКАЧКИ ТОРМОЗОВ	INDEKS INDEX ИНДЕКС	POŁOŻENIE LOCATION МЕСТО	OPIS DESCRIPTION ОПИСАНИЕ
Mazda 323						
FA Wagon	ZWP-6509	10.81>12.85	0086P	WP-230	PL	113 113 0700
				WP-796	PP	113 113 1150
				WP-794	TL	113 113 0500
				WP-798	TP	113 113 1500
				WP-801	CC	113 113 4200
			0090T			
Mazda 323						
GB Hatchback, Sedan	ZWP-6510	06.89>02.91	0090P	WP-133	PL	116 116 1100
				WP-132	PP	116 116 1050
				WP-136	TL	116 116 0850
				WP-141	TP	116 116 0600
				WP-118	ZTL	116 116 0300
				WP-118	ZTP	116 116 0300
				WP-449	CL	116 116 3800
				WP-449	CP	116 116 3800
			0089T			
Mazda 323						
BA bez ABS without ABS без ABS	ZWP-6511	06.94>04.98	0090P	WP-133	PL	116 116 1100
				WP-429	PP	116 116 1000
				WP-133	TL	116 116 1100
				WP-135	ZTL	116 116 0150
				WP-135	ZTP	116 116 0150
				WP-821	CL	116 116 3000
			0089T	WP-821	CP	116 116 3000
Mazda 323						
BA Diesel bez F bez ABS BA Diesel without F, without ABS BA Diesel без F, без ABS	ZWP-6512	10.96>04.98	0090P	WP-581	PL	116 116 1400
				WP-429	PP	116 116 1000
				WP-133	TL	116 116 1100
				WP-135	ZTL	116 116 0150
				WP-135	ZTP	116 116 0150
				WP-821	CL	116 116 3000
			0089T	WP-821	CP	116 116 3000
Mazda 323						
BA, F 1500 z ABS with ABS c ABS	ZWP-6513	05.94>07.95	0090P	WP-131	PL	116 116 0700
				WP-136	PP	116 116 0850
				WP-133	TL	116 116 1100
				WP-134	ZTL	116 116 0500
				WP-134	ZTP	116 116 0500
				WP-821	CL	116 116 3000
			0089T	WP-821	CP	116 116 3000
Mazda 323						
BA, F 1500, 1800 z ABS with ABS c ABS	ZWP-6514	08.95>04.98	0090P	WP-131	PL	116 116 0700
				WP-136	PP	116 116 0850
				WP-133	TL	116 116 1100
				WP-135	ZTL	116 116 0150
				WP-135	ZTP	116 116 0150
				WP-821	CL	116 116 3000
			0089T	WP-821	CP	116 116 3000
Mazda 323						
BA, F, 2000 bez ABS without ABS без ABS	ZWP-6515	05.94>04.98	0090P	WP-581	PL	116 116 1400
				WP-429	PP	116 116 1000
				WP-133	TL	116 116 1100
				WP-821	CL	116 116 3000
				WP-821	CP	116 116 3000
			0089T			
Mazda 323						
BA, 2000 z ABS with ABS c ABS	ZWP-6516	05.94>	0090P	WP-131	PL	116 116 0700
				WP-812	PP	116 116 1750
				WP-133	TL	116 116 1100
				WP-821	CL	116 116 3000
				WP-821	CP	116 116 3000
			0089T			
Mazda 323						
BJ z ABS with ABS c ABS	ZWP-6517	05.98>10.03		WP-136	PL	116 116 0850
				WP-146	PP	116 116 2100
				WP-823	CL	116 116 3250
				WP-828	CP	116 116 4400
Mazda 616						
Wszystkie modele All models Все модели *69 *72	ZWP-6518	70>78	0086P	WP-242	PL	113 113 1050
				WP-234	PP	113 113 0550
				WP-243	TL	113 113 0450
				WP-244	TP	113 113 1000
				WP-232	CC	113 113 3000
			0089T			
Mazda 626						
CB	ZWP-6519	02.79>08.80	0090P	WP-238	PL	113 113 0350
				WP-247	PP	113 113 1950
				WP-234	TL	113 113 0550
				WP-248	TP	113 113 1600
				WP-800	CC	113 113 2800
			0089T			

MARKA SAMOCHODU
CAR MODEL
МОДЕЛЬ АВТОМБИЯ

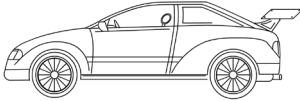

NUMER ZESTAWU
SET NUMBER
НОМЕР НАБОРА

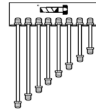

ROK PRODUKCJI
PRODUCTION YEAR
ГОД ВЫПУСКА АВТОМБИЯ



ODPOWIETRZNIK
BLEEDER SCREW
ШТУЦЕР ПРОКАЧКИ ТОРМОЗОВ

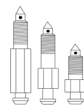

INDEKS
INDEX
ИНДЕКС



POŁOŻENIE
LOCATION
МЕСТО

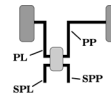

OPIS
DESCRIPTION
ОПИСАНИЕ

ZŁĄCZKA ZŁĄCZKA DŁUGOŚĆ
FITTING FITTING LENGTH
НАКОНЕЧНИК НАКОНЕЧНИК ДЛИНА

MARKA SAMOCHODU CAR MODEL МОДЕЛЬ АВТОМБИЯ	NUMER ZESTAWU SET NUMBER НОМЕР НАБОРА	ROK PRODUKCJI PRODUCTION YEAR ГОД ВЫПУСКА АВТОМБИЯ	ODPOWIETRZNIK BLEEDER SCREW ШТУЦЕР ПРОКАЧКИ ТОРМОЗОВ	INDEKS INDEX ИНДЕКС	POŁOŻENIE LOCATION МЕСТО	OPIS DESCRIPTION ОПИСАНИЕ
Mazda 626						
BG	ZWP-6520	09.80>10.82	0090P	WP-134	PL	116 116 0500
				WP-815	PP	116 116 2150
				WP-141	TL	116 116 0600
				WP-251	TP	116 116 1600
			0089T	WP-121	CC	116 116 2800
Mazda 626						
GC	ZWP-6521	11.82>06.85	0086P	WP-131	PL	116 116 0700
				WP-132	PP	116 116 1050
				WP-118	TL	116 116 0300
				WP-125	TP	116 116 0750
				WP-118	ZTL	116 116 0300
				WP-118	ZTP	116 116 0300
			0089T	WP-236	CL	116 116 3200
			0086T	WP-143	CP	116 116 3300
Mazda 626						
GC	ZWP-6522	07.85>05.87	0086P	WP-125	PL	116 116 0750
				WP-132	PP	116 116 1050
				WP-148	TL	116 116 0800
				WP-118	ZTL	116 116 0300
				WP-118	ZTP	116 116 0300
			0089T	WP-236	CL	116 116 3200
			0086T	WP-824	CP	116 116 3350
Mazda 626						
GD 2WS	ZWP-6523	06.87>08.91	0088P	WP-125	PL	116 116 0750
				WP-429	PP	116 116 1000
				WP-131	TL	116 116 0700
				WP-118	ZTL	116 116 0300
				WP-118	ZTP	116 116 0300
				WP-823	CL	116 116 3250
			0086T	WP-825	CP	116 116 3450
*66						
Mazda 626						
GD 2WS	ZWP-6524	06.87>08.91	0088P	WP-125	PL	116 116 0750
				WP-429	PP	116 116 1000
				WP-131	TL	116 116 0700
				WP-823	CL	116 116 3250
			0086T	WP-825	CP	116 116 3450
*67						
Mazda 626						
GE 4-drzwi, 5-drzwi 2WD bez ABS GE 4-doors, 5-doors 2WD without ABS GE 4-двери, 5-дверин 2WD без ABS	ZWP-6525	08.91>08.97	0086P	WP-131	PL	116 116 0700
				WP-145	PP	116 116 1850
				WP-828	CL	116 116 4400
			0086T	WP-823	CP	116 116 3250
Mazda 626						
GE 4-drzwi, 5-drzwi 2WD z ABS GE 4-doors, 5-doors 2WD with ABS, without diesel GE 4-двери, 5-дверин 2WD c ABS, без diesel	ZWP-6526	08.91>08.97	0086P	WP-144	PL	116 116 0400
				WP-222	PP	116 116 1650
				WP-823	CL	116 116 3250
			0086T	WP-828	CP	116 116 4400
Mazda 626						
GV Kombi 2WD bez ABS, bez diesel without ABS, without diesel без ABS, без diesel	ZWP-6524	10.89>02.92	0086P	WP-125	PL	116 116 0750
				WP-429	PP	116 116 1000
				WP-131	TL	116 116 0700
				WP-823	CL	116 116 3250
			0086T	WP-825	CP	116 116 3450
Mazda 626						
GV Kombi 2WD z ABS, bez diesel with ABS, without diesel c ABS, без diesel	ZWP-6524	10.89>02.92	0086P	WP-125	PL	116 116 0750
				WP-429	PP	116 116 1000
				WP-131	TL	116 116 0700
				WP-823	CL	116 116 3250
			0086T	WP-825	CP	116 116 3450
Mazda 626						
GV Kombi 2WD bez ABS, bez diesel without ABS, without diesel без ABS, без diesel	ZWP-6529	03.92>97	0086P	WP-125	PL	116 116 0750
				WP-429	PP	116 116 1000
				WP-131	TL	116 116 0700
				WP-823	CL	116 116 3250
			0086T	WP-143	CP	116 116 3300
Mazda 626						
GV Kombi 2WD z ABS z ABS, bez diesel with ABS, without diesel c ABS, без diesel	ZWP-6530	03.92>97	0086P	WP-134	PL	116 116 0500
				WP-581	PP	116 116 1400
				WP-131	TL	116 116 0700
				WP-823	CL	116 116 3250
			0086T	WP-825	CP	116 116 3450
Mazda 626						
GF z ABS with ABS c ABS	ZWP-6531	02.98>10.02	0088P	WP-123	PL	116 116 0450
				WP-812	PP	116 116 1750
				WP-144	TL	116 116 0400
				WP-144	TP	116 116 0400
				WP-143	CL	116 116 3300
			0086T	WP-828	CP	116 116 4400
*66						

MARKA SAMOCHODU
CAR MODEL
МОДЕЛЬ АВТОМБИЯ

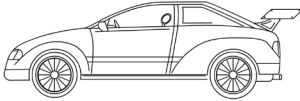

NUMER ZESTAWU
SET NUMBER
НОМЕР НАБОРА

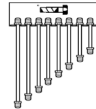

ROK PRODUKCJI
PRODUCTION YEAR
ГОД ВЫПУСКА АВТОМБИЯ



ODPOWIETRZNIK
BLEEDER SCREW
ШТУЦЕР ПРОКАЧКИ ТОРМОЗОВ

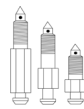

INDEKS
INDEX
ИНДЕКС



POŁOŻENIE
LOCATION
МЕСТО

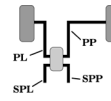

OPIS
DESCRIPTION
ОПИСАНИЕ

ZŁĄCZKA
FITTING
НАКОНЕЧНИК

ZŁĄCZKA
FITTING
НАКОНЕЧНИК

DŁUGOŚĆ
LENGTH
ДЛИНА

MARKA SAMOCHODU CAR MODEL МОДЕЛЬ АВТОМБИЯ	NUMER ZESTAWU SET NUMBER НОМЕР НАБОРА	ROK PRODUKCJI PRODUCTION YEAR ГОД ВЫПУСКА АВТОМБИЯ	ODPOWIETRZNIK BLEEDER SCREW ШТУЦЕР ПРОКАЧКИ ТОРМОЗОВ	INDEKS INDEX ИНДЕКС	POŁOŻENIE LOCATION МЕСТО	OPIS DESCRIPTION ОПИСАНИЕ
Mazda 626						
GW z ABS with ABS с ABS	ZWP-6532	02.98>10.02	0088P	WP-123	PL	116 116 0450
				WP-812	PP	116 116 1750
				WP-143	CL	116 116 3300
			0086T	WP-828	CP	116 116 4400
Mazda 818						
Wszystkie modele All models Все модели	ZWP-6533	73>78	0091P	WP-230	PL	113 113 0700
				WP-239	PP	113 113 1200
				WP-238	TL	113 113 0350
				WP-242	TP	113 113 1050
			0089T	WP-245	CC	113 113 2600
Mazda 626						
Wszystkie modele All models Все модели	ZWP-6534	73>80	0086P	WP-246	PL	113 113 0200
				WP-247	PP	113 113 1950
				WP-234	TL	113 113 0550
				WP-248	TP	113 113 1600
			0089T	WP-249	CC	113 113 2900
Mazda 1300						
Sedan	ZWP-6535	01.71>76	0091P	WP-237	ZPL	113 113 0300
				WP-237	ZPP	113 113 0300
				WP-237	PL	113 113 0300
				WP-233	PP	113 113 0850
*02				WP-231	TL	113 113 1100
*69				WP-793	TP	113 113 0400
*73			0090T	WP-249	CC	113 113 2900
Mazda 1300						
Sedan	ZWP-6536	01.71<07.75	0091P	WP-237	ZPL	113 113 0300
				WP-237	ZPP	113 113 0300
				WP-237	PL	113 113 0300
				WP-233	PP	113 113 0850
*02				WP-233	TL	113 113 0850
*69				WP-234	TP	113 113 0550
*74			0090T	WP-232	CC	113 113 3000
Mazda 1300						
Kombi	ZWP-6537	01.71>76	0091P	WP-237	ZPL	113 113 0300
				WP-237	ZPP	113 113 0300
				WP-246	PL	113 113 0200
				WP-797	PP	113 113 1400
				WP-242	TL	113 113 1050
*02				WP-793	TP	113 113 0400
*69				WP-795	SP	113 113 0900
*73			0090T	WP-246	ST	113 113 2600
Mazda 1300						
Kombi	ZWP-6538	01.71>76	0091P	WP-237	ZPL	113 113 0300
				WP-237	ZPP	113 113 0300
				WP-238	PL	113 113 0350
				WP-239	PP	113 113 1200
				WP-233	TL	113 113 0850
				WP-234	TP	113 113 0550
*02				WP-799	CL	113 113 2350
*69				WP-240	SPP	113 113 0650
*74			0090T	WP-237	STP	113 113 0300
Mazda B						
2000, 2200, 2600	ZWP-6539	11.89>96	0086P	WP-134	PL	116 116 0500
				WP-813	PP	116 116 1950
				WP-223	TL	116 116 1550
kabina cockpit кабина				WP-120	TP	116 116 0550
				WP-449	SP	116 116 3800
				WP-810	ST	116 116 1250
Mazda B						
2000, 2200, 2600	ZWP-6540	11.89>96	0086P	WP-134	PL	116 116 0500
				WP-813	PP	116 116 1950
				WP-223	TL	116 116 1550
podwójna kabina dual cockpit двойная кабина				WP-120	TP	116 116 0550
				WP-823	SP	116 116 3250
				WP-126	ST	116 116 0900
Mazda E						
2000, 2200 Van, Kombi	ZWP-6541	01.84>11.87	0090P	WP-223	PL	116 116 1550
				WP-223	PP	116 116 1550
				WP-429	TL	116 116 1000
				WP-251	TP	116 116 1600
koła pojedyncze single wheels одинарные колеса				WP-420	SP	116 116 4200
			0089T	WP-118	ST	116 116 0300
Mazda E						
2000, 2200 Pick-up	ZWP-6542	12.87>	0090P	WP-124	PL	116 116 1350
				WP-235	PP	116 116 2200
				WP-133	TL	116 116 1100
				WP-222	TP	116 116 1650
koła pojedyncze single wheels одинарные колеса				WP-449	SP	116 116 3800
			0089T	WP-581	ST	116 116 1400

MARKA SAMOCHODU
CAR MODEL
МОДЕЛЬ АВТОМОБИЛЯ

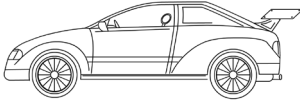

NUMER ZESTAWU
SET NUMBER
НОМЕР НАБОРА

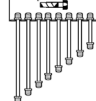

ROK PRODUKCJI
PRODUCTION YEAR
ГОД ВЫПУСКА АВТОМОБИЛЯ



ODPOWIETRZNIK
BLEEDER SCREW
ШТУЦЕР ПРОКАЧКИ ТОРМОЗОВ

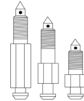

INDEKS
INDEX
ИНДЕКС



POŁOŻENIE
LOCATION
МЕСТО

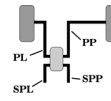

OPIS
DESCRIPTION
ОПИСАНИЕ

ZŁĄCZKA
FITTING
НАКОНЕЧНИК

ZŁĄCZKA
FITTING
НАКОНЕЧНИК

DŁUGOŚĆ
LENGTH
ДЛИНА

MARKA SAMOCHODU CAR MODEL МОДЕЛЬ АВТОМОБИЛЯ	NUMER ZESTAWU SET NUMBER НОМЕР НАБОРА	ROK PRODUKCJI PRODUCTION YEAR ГОД ВЫПУСКА АВТОМОБИЛЯ	ODPOWIETRZNIK BLEEDER SCREW ШТУЦЕР ПРОКАЧКИ ТОРМОЗОВ	INDEKS INDEX ИНДЕКС	POŁOŻENIE LOCATION МЕСТО	OPIS DESCRIPTION ОПИСАНИЕ				
Mazda E										
2000, 2200 Pick-up	ZWP-6543	12.87>	0090P	WP-810	PL	116 116 1250				
koła podwójne twin wheels двойные колеса				WP-810	PP	116 116 1250				
				WP-136	TL	116 116 0850				
				WP-124	TP	116 116 1350				
				WP-449	CC	116 116 3800				
			0089T							
Mazda E										
2000, 2200 Van, Kombi	ZWP-6544	12.87>	0090P	WP-223	PL	116 116 1550				
				WP-223	PP	116 116 1550				
				WP-429	TL	116 116 1000				
				WP-251	TP	116 116 1600				
				WP-826	SP	116 116 3950				
				WP-144	ST	116 116 0400				
			0089T							
Mercedes A (W168)										
Wszystkie modele All models Все модели	ZWP-6651	07.97>08.04		WP-028	PL	105 105 0550				
*66				WP-435	PP	105 105 1600				
				WP-048	CL	105 105 2500				
				WP-030	CP	105 105 3700				
				WP-033	TL	105 105 0700				
				WP-033	TP	105 105 0700				
Mercedes A (W168)										
Wszystkie modele All models Все модели	ZWP-6652	07.97>08.04		WP-028	PL	105 105 0550				
*67				WP-435	PP	105 105 1600				
				WP-048	CL	105 105 2500				
				WP-030	CP	105 105 3700				
				WP-018	TL	105 105 0650				
				WP-018	TP	105 105 0650				
Mercedes A (W169)										
Wszystkie modele All models Все модели	ZWP-6653	09.04>		WP-028	PL	105 105 0550				
*66				WP-435	PP	105 105 1600				
				WP-020	CL	105 105 3400				
				WP-025	CP	105 105 4300				
				WP-033	TL	105 105 0700				
				WP-033	TP	105 105 0700				
Mercedes A (W169)										
Wszystkie modele All models Все модели	ZWP-6654	09.04>		WP-028	PL	105 105 0550				
*67				WP-435	PP	105 105 1600				
				WP-020	CL	105 105 3400				
				WP-025	CP	105 105 4300				
				WP-018	TL	105 105 0650				
				WP-018	TP	105 105 0650				
Mercedes-Benz W114										
	ZWP-6601	68>70	0010P	WP-001	PL	105 105 0300				
				0011P	WP-034	PP	105 105 1200			
					WP-041	TL	105 105 0350			
				0088T	WP-035	TP	105 105 1100			
				0011T	WP-167	CC	105 105 2600			
				Mercedes-Benz W114						
Diesel	ZWP-6602	68>70	0010P	WP-001	PL	105 105 0300				
				0011P	WP-034	PP	105 105 1200			
					WP-024	TL	105 105 0800			
				0088T	WP-024	TP	105 105 0800			
				0011T	WP-167	CC	105 105 2600			
				Mercedes-Benz W114						
	ZWP-6603	71>76	0085P	WP-043	ZPL	105 105 0200				
				0011P	WP-043	ZPP	105 105 0200			
					WP-001	PL	105 105 0300			
					WP-196	PP	105 105 1300			
					WP-001	TL	105 105 0300			
					WP-013	TP	105 105 0900			
					WP-043	ZTL	105 105 0200			
					WP-043	ZTP	105 105 0200			
					WP-030	CC	105 105 3700			
							0088T			
							0011T			
Mercedes-Benz W123										
Wszystkie modele All models Все модели	ZWP-6604	01.76>83	0085P	WP-045	PL	105 105 0400				
				0011P	WP-047	PP	105 105 1500			
					WP-005	TL	105 105 0450			
				0088T	WP-013	TP	105 105 0900			
				0011T	WP-040	CC	105 105 3300			
				Mercedes-Benz W124						
Wszystkie modele bez ABS, do Nr A060861 All models without ABS, to no.A060861 Все модели без ABS, к нет.A060861	ZWP-6605	01.85>08.89	0085P	WP-017	PL	105 105 0500				
				0011P	WP-047	PP	105 105 1500			
					WP-017	TL	105 105 0500			
				0088T	WP-013	TP	105 105 0900			
				0011T	WP-358	CC	105 105 4000			
Mercedes-Benz W124										
Wszystkie modele bez ABS, od Nr A060862 All models without ABS, from no.A060862 Все модели без ABS, от нет.A060862	ZWP-6606	01.85>08.89	0085P	WP-009	PL	105 105 0600				
				0011P	WP-042	PP	105 105 1700			
					WP-017	TL	105 105 0500			
				0088T	WP-013	TP	105 105 0900			
				0011T	WP-358	CC	105 105 4000			

MARKA SAMOCHODU
CAR MODEL
МОДЕЛЬ АВТОМБИЛЯ

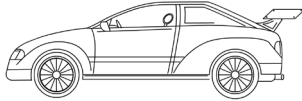

NUMER ZESTAWU
SET NUMBER
НОМЕР НАБОРА

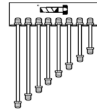

ROK PRODUKCJI
PRODUCTION YEAR
ГОД ВЫПУСКА АВТОМБИЛЯ



ODPOWIETRZNIK
BLEEDER SCREW
ШТУЦЕР ПРОКАЧКИ ТОРМОЗОВ

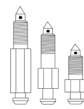

INDEKS
INDEX
ИНДЕКС



POŁOŻENIE
LOCATION
МЕСТО

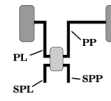

OPIS
DESCRIPTION
ОПИСАНИЕ

ZŁĄCZKA FITTING
НАКОНЕЧНИК
ZŁĄCZKA FITTING
НАКОНЕЧНИК
DŁUGOŚĆ LENGTH
ДЛИНА

MARKA SAMOCHODU CAR MODEL МОДЕЛЬ АВТОМБИЛЯ	NUMER ZESTAWU SET NUMBER НОМЕР НАБОРА	ROK PRODUKCJI PRODUCTION YEAR ГОД ВЫПУСКА АВТОМБИЛЯ	ODPOWIETRZNIK BLEEDER SCREW ШТУЦЕР ПРОКАЧКИ ТОРМОЗОВ	INDEKS INDEX ИНДЕКС	POŁOŻENIE LOCATION МЕСТО	OPIS DESCRIPTION ОПИСАНИЕ
Mercedes-Benz W124						
Wszystkie modele bez 4x4, z ABS, Nr A0608, Nr A060082 All models without 4x4, with ABS, no.A0608, no.A060082 Все модели без 4x4, с ABS, нет.A0608, Nr A060082	ZWP-6607	01.85>08.89	0085P 0011P 0088T 0011T	WP-252	PL	105 105 1050
				WP-428	PP	105 105 2050
				WP-017	TL	105 105 0500
				WP-013	TP	105 105 0900
				WP-042	SP	105 105 1700
				WP-433	ST	105 105 2950
Mercedes-Benz W124						
Wszystkie modele bez 4x4, z ABS, Nr A060862 - A476019 All models without 4x4, with ABS, no.A060862 - A476019 Все модели без 4x4, с ABS, нет.A060862 - A476019	ZWP-6608	01.85>08.89	0085P 0011P 0088T 0011T	WP-252	PL	105 105 1050
				WP-015	PP	105 105 2700
				WP-017	TL	105 105 0500
				WP-013	TP	105 105 0900
				WP-042	SP	105 105 1700
				WP-433	ST	105 105 2950
Mercedes-Benz W124						
Wszystkie modele bez 4x4, z ABS, Nr A476020 - All models without 4x4, with ABS, no.A476020 - Все модели без 4x4, с ABS, нет.A476020 -	ZWP-6609	01.85>08.89	0085P 0011P 0088T 0011T	WP-027	PL	105 105 1250
				WP-390	PP	105 105 2250
				WP-017	TL	105 105 0500
				WP-013	TP	105 105 0900
				WP-012	SP	105 105 1650
				WP-433	ST	105 105 2950
Mercedes-Benz W124						
TD, Model B z ABS with ABS с ABS	ZWP-6610	89>95		WP-256	CP	105 105 1750
				WP-433	CL	105 105 2950
				WP-017	TL	105 105 0500
				WP-002	TP	105 105 0850
				WP-034	PL	105 105 1200
				WP-036	PP	105 105 2100
				WP-013	POM-ABS	105 105 0900
				WP-002	POM-ABS	105 105 0850
Mercedes-Benz W126						
Wszystkie modele, bez ABS All models, without ABS Все модели, без ABS	ZWP-6611	>84	0085P 0011P 0088T 0011T	WP-017	PL	105 105 0500
				WP-047	PP	105 105 1500
				WP-045	TL	105 105 0400
				WP-252	TP	105 105 1050
				WP-711	CC	105 105 3550
Mercedes-Benz W126						
Wszystkie modele, z ABS All models, with ABS Все модели, с ABS	ZWP-6612	>08.85	0085P 0011P 0088T 0011T	WP-047	PL	105 105 1000
				WP-036	PP	105 105 2100
				WP-024	TL	105 105 0800
				WP-047	TP	105 105 1000
				WP-042	SP	105 105 1700
				WP-432	ST	105 105 3250
Mercedes-Benz W126						
Wszystkie modele, z ABS All models, with ABS Все модели, с ABS	ZWP-6613	09.85>93	0085P 0011P 0088T 0011T	WP-047	PL	105 105 1000
				WP-036	PP	105 105 2100
				WP-041	TL	105 105 0350
				WP-047	TP	105 105 1000
				WP-042	SP	105 105 1700
				WP-706	ST	105 105 2450
Mercedes-Benz W201						
Wszystkie modele, bez ABS, Nr 179755 All models, without ABS, no.179755 Все модели, без ABS, нет.179755	ZWP-6614	04.82>85	0011P 0015T	WP-028	PL	105 105 0550
				WP-039	PP	105 105 1550
				WP-018	TL	105 105 0650
				WP-033	TP	105 105 0700
				WP-534	CC	105 105 3750
Mercedes-Benz W201						
Wszystkie modele, z ABS, Nr 179755 All models, with ABS, no.179755 Все модели, с ABS, нет.179755	ZWP-6615	04.82>85	0011P 0015T	WP-033	PL	105 105 0700
				WP-428	PP	105 105 2050
				WP-018	TL	105 105 0650
				WP-033	TP	105 105 0700
				WP-356	SP	105 105 1450
				WP-015	ST	105 105 2700
Mercedes-Benz W201						
190, 190E, 190D bez ABS, Nr 179756 without ABS, no.179756 без ABS, нет.179756	ZWP-6616	85>93	0011P 0015T	WP-018	PL	105 105 0650
				WP-012	PP	105 105 1650
				WP-018	TL	105 105 0650
				WP-033	TP	105 105 0700
				WP-534	CC	105 105 3750
Mercedes-Benz W201						
190, 190E, 190D z ABS, Nr 179756 with ABS, no.179756 с ABS, нет.179756	ZWP-6617	85>93	0011P 0015T	WP-013	PL	105 105 0900
				WP-428	PP	105 105 2050
				WP-018	TL	105 105 0650
				WP-033	TP	105 105 0700
				WP-356	SP	105 105 1450
				WP-015	ST	105 105 2700

MARKA SAMOCHODU
CAR MODEL
МОДЕЛЬ АВТОМБИЯ

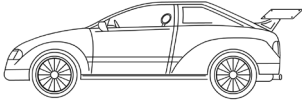

NUMER ZESTAWU
SET NUMBER
НОМЕР НАБОРА

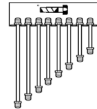

ROK PRODUKCJI
PRODUCTION YEAR
ГОД ВЫПУСКА АВТОМБИЯ



ODPOWIETRZNIK
BLEEDER SCREW
ШТУЦЕР ПРОКАЧКИ ТОРМОЗОВ

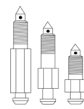

INDEKS
INDEX
ИНДЕКС



POŁOŻENIE
LOCATION
МЕСТО

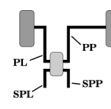

OPIS
DESCRIPTION
ОПИСАНИЕ

ZŁĄCZKA
FITTING
НАКОНЕЧНИК

ZŁĄCZKA
FITTING
НАКОНЕЧНИК

DŁUGOŚĆ
LENGTH
ДЛИНА

Mercedes-Benz W201	ZWP-6618	11.87>93	0011P	WP-018	PL	105 105 0650
190D 2.5TD bez ABS without ABS без ABS				WP-031	PP	105 105 2200
				WP-018	TL	105 105 0650
				WP-033	TP	105 105 0700
			0015T	WP-534	CC	105 105 3750
Mercedes-Benz W201	ZWP-6619	11.87>93	0011P	WP-013	PL	105 105 0900
190D 2.5TD z ABS with ABS c ABS				WP-023	PP	105 105 1800
				WP-018	TL	105 105 0650
				WP-033	TP	105 105 0700
				WP-356	SP	105 105 1450
			0015T	WP-015	ST	105 105 2700
Mercedes-Benz W201	ZWP-6619	04.86>93	0011P	WP-013	PL	105 105 0900
190E 2.6 z ABS with ABS c ABS				WP-023	PP	105 105 1800
				WP-018	TL	105 105 0650
				WP-033	TP	105 105 0700
				WP-356	SP	105 105 1450
			0015T	WP-015	ST	105 105 2700
Mercedes-Benz W210	ZWP-6620	05.99>03.02		WP-024	PL	105 105 0800
220 CDI, 320 CDI				WP-031	PP	105 105 2200
				WP-029	CL	105 105 3200
				WP-007	CP	105 105 3900
				WP-252	TL	105 105 1050
				WP-115	TP	105 105 1150
Mercedes-Benz W211	ZWP-6621	01.02>		WP-014	PL	105 105 2400
E220 CDI, E320 CDI, E270 CDI				WP-027	PP	105 105 1250
				WP-036	TL	105 105 2100
				WP-571	TP	105 105 3850
				WP-036	CC	105 105 2100
Mercedes-Benz L200	ZWP-6622		0039P	WP-043	ZPL	105 105 0200
207D, 208D (371, 376)				WP-043 <td>ZPP</td> <td>105 105 0200</td>	ZPP	105 105 0200
				WP-013 <td>PL</td> <td>105 105 0900</td>	PL	105 105 0900
				WP-031 <td>PP</td> <td>105 105 2200</td>	PP	105 105 2200
				WP-027 <td>TL</td> <td>105 105 1250</td>	TL	105 105 1250
				WP-033 <td>TP</td> <td>105 105 0700</td>	TP	105 105 0700
				WP-015 <td>SP</td> <td>105 105 2900</td>	SP	105 105 2900
			0033T	WP-033	ST	105 105 0700
Mercedes-Benz L200	ZWP-6623		0039P	WP-043	ZPL	105 105 0200
207D, 208D (372, 377)				WP-043 <td>ZPP</td> <td>105 105 0200</td>	ZPP	105 105 0200
				WP-013 <td>PL</td> <td>105 105 0900</td>	PL	105 105 0900
				WP-031 <td>PP</td> <td>105 105 2200</td>	PP	105 105 2200
				WP-027 <td>TL</td> <td>105 105 1250</td>	TL	105 105 1250
				WP-033 <td>TP</td> <td>105 105 0700</td>	TP	105 105 0700
				WP-029 <td>SP</td> <td>105 105 3200</td>	SP	105 105 3200
			0033T	WP-033 <td>ST</td> <td>105 105 0700</td>	ST	105 105 0700
Mercedes-Benz L200	ZWP-6624		0039P	WP-043	ZPL	105 105 0200
208, 210 (071, 076)				WP-043 <td>ZPP</td> <td>105 105 0200</td>	ZPP	105 105 0200
				WP-013 <td>PL</td> <td>105 105 0900</td>	PL	105 105 0900
				WP-031 <td>PP</td> <td>105 105 2200</td>	PP	105 105 2200
				WP-027 <td>TL</td> <td>105 105 1250</td>	TL	105 105 1250
				WP-033 <td>TP</td> <td>105 105 0700</td>	TP	105 105 0700
				WP-016 <td>SP</td> <td>105 105 2900</td>	SP	105 105 2900
			0033T	WP-033 <td>ST</td> <td>105 105 0700</td>	ST	105 105 0700
Mercedes-Benz L200	ZWP-6623		0039P	WP-043	ZPL	105 105 0200
208, 210 (072, 077)				WP-043 <td>ZPP</td> <td>105 105 0200</td>	ZPP	105 105 0200
				WP-013 <td>PL</td> <td>105 105 0900</td>	PL	105 105 0900
				WP-031 <td>PP</td> <td>105 105 2200</td>	PP	105 105 2200
				WP-027 <td>TL</td> <td>105 105 1250</td>	TL	105 105 1250
				WP-033 <td>TP</td> <td>105 105 0700</td>	TP	105 105 0700
				WP-029 <td>SP</td> <td>105 105 3200</td>	SP	105 105 3200
			0033T	WP-033 <td>ST</td> <td>105 105 0700</td>	ST	105 105 0700
Mercedes-Benz L200	ZWP-6625		0039P	WP-043	ZPL	105 105 0200
209D, 210D (476)				WP-043 <td>ZPP</td> <td>105 105 0200</td>	ZPP	105 105 0200
				WP-013 <td>PL</td> <td>105 105 0900</td>	PL	105 105 0900
				WP-031 <td>PP</td> <td>105 105 2200</td>	PP	105 105 2200
				WP-027 <td>TL</td> <td>105 105 1250</td>	TL	105 105 1250
				WP-033 <td>TP</td> <td>105 105 0700</td>	TP	105 105 0700
				WP-048 <td>SP</td> <td>105 105 2500</td>	SP	105 105 2500
			0033T	WP-033 <td>ST</td> <td>105 105 0700</td>	ST	105 105 0700

MARKA SAMOCHODU
CAR MODEL
МОДЕЛЬ АВТОМБИЯ

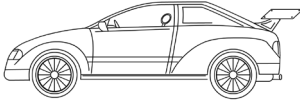

NUMER ZESTAWU
SET NUMBER
НОМЕР НАБОРА

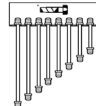

ROK PRODUKCJI
PRODUCTION YEAR
ГОД ВЫПУСКА АВТОМБИЯ



ODPOWIETRZNIK
BLEEDER SCREW
ШТУЦЕР ПРОКАЧКИ ТОРМОЗОВ

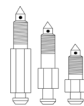

INDEKS
INDEX
ИНДЕКС



POŁOŻENIE
LOCATION
МЕСТО

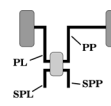

OPIS
DESCRIPTION
ОПИСАНИЕ

ZŁĄCZKA ZŁĄCZKA DŁUGOŚĆ
FITTING FITTING LENGTH
НАКОНЕЧНИК НАКОНЕЧНИК ДЛИНА

Mercedes-Benz L200						
Nr 027688, 649391-999999 207D, 208D (311, 312, 316, 317, 361, 366)	ZWP-6626		0039P	WP-205	ZPL	105 105 0150
				WP-205	ZPP	105 105 0150
				WP-013	PL	105 105 0900
				WP-031	PP	105 105 2200
				WP-027	TL	105 105 1250
				WP-033	TP	105 105 0700
				WP-016	SP	105 105 2900
				0033T	WP-033	ST
Mercedes-Benz L200						
Nr 027688, 649391-999999 207D, 208D (018)	ZWP-6627		0039P	WP-205	ZPL	105 105 0150
				WP-205	ZPP	105 105 0150
				WP-013	PL	105 105 0900
				WP-031	PP	105 105 2200
				WP-027	TL	105 105 1250
				WP-033	TP	105 105 0700
				WP-029	SP	105 105 3200
				0033T	WP-033	ST
Mercedes-Benz L200						
Nr 027688, 649391-999999 207D, 208D (362, 367)	ZWP-6627		0039P	WP-205	ZPL	105 105 0150
				WP-205	ZPP	105 105 0150
				WP-013	PL	105 105 0900
				WP-031	PP	105 105 2200
				WP-027	TL	105 105 1250
				WP-033	TP	105 105 0700
				WP-029	SP	105 105 3200
				0033T	WP-033	ST
Mercedes-Benz L200						
Nr 027688, 649391-999999 208, 210 (011, 012, 016, 017, 061, 066)	ZWP-6626		0039P	WP-205	ZPL	105 105 0150
				WP-205	ZPP	105 105 0150
				WP-013	PL	105 105 0900
				WP-031	PP	105 105 2200
				WP-027	TL	105 105 1250
				WP-033	TP	105 105 0700
				WP-016	SP	105 105 2900
				0033T	WP-033	ST
Mercedes-Benz L200						
Nr 027688, 649391-999999 208, 210 (018)	ZWP-6627		0039P	WP-205	ZPL	105 105 0150
				WP-205	ZPP	105 105 0150
				WP-013	PL	105 105 0900
				WP-031	PP	105 105 2200
				WP-027	TL	105 105 1250
				WP-033	TP	105 105 0700
				WP-029	SP	105 105 3200
				0033T	WP-033	ST
Mercedes-Benz L200						
Nr 027688, 649391-999999 209D, 210D (411, 416, 461, 466)	ZWP-6625		0039P	WP-043	ZPL	105 105 0200
				WP-043	ZPP	105 105 0200
				WP-013	PL	105 105 0900
				WP-031	PP	105 105 2200
				WP-027	TL	105 105 1250
				WP-033	TP	105 105 0700
				WP-048	SP	105 105 2500
				0033T	WP-033	ST
Mercedes-Benz L200						
Nr 027688, 649391-999999 209D, 210D (412, 417)	ZWP-6624		0039P	WP-043	ZPL	105 105 0200
				WP-043	ZPP	105 105 0200
				WP-013	PL	105 105 0900
				WP-031	PP	105 105 2200
				WP-027	TL	105 105 1250
				WP-033	TP	105 105 0700
				WP-016	SP	105 105 2900
				0033T	WP-033	ST
Mercedes-Benz L200						
Nr 027688, 649391-999999 209D, 210D (418)	ZWP-6628		0039P	WP-043	ZPL	105 105 0200
				WP-043	ZPP	105 105 0200
				WP-013	PL	105 105 0900
				WP-031	PP	105 105 2200
				WP-027	TL	105 105 1250
				WP-033	TP	105 105 0700
				WP-020	SP	105 105 3400
				0033T	WP-033	ST
Mercedes-Benz L200						
Nr 027688, 649391-999999 209D, 210D (462, 467)	ZWP-6629		0039P	WP-043	ZPL	105 105 0200
				WP-043	ZPP	105 105 0200
				WP-013	PL	105 105 0900
				WP-031	PP	105 105 2200
				WP-027	TL	105 105 1250
				WP-033	TP	105 105 0700
				WP-004	SP	105 105 3100
				0033T	WP-033	ST

MARKA SAMOCHODU
CAR MODEL
МОДЕЛЬ АВТОМБИЯ

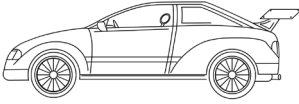

NUMER ZESTAWU
SET NUMBER
НОМЕР НАБОРА

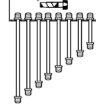

ROK PRODUKCJI
PRODUCTION YEAR
ГОД ВЫПУСКА АВТОМБИЯ



ODPOWIETRZNIK
BLEEDER SCREW
ШТУЦЕР ПРОКАЧКИ ТОРМОЗОВ

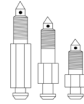

INDEKS
INDEX
ИНДЕКС



POŁOŻENIE
LOCATION
МЕСТО

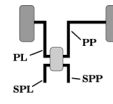

OPIS
DESCRIPTION
ОПИСАНИЕ

ZŁĄCZKA ZŁĄCZKA DŁUGOŚĆ
FITTING FITTING LENGTH
НАКОНЕЧНИК НАКОНЕЧНИК ДЛИНА

Mercedes-Benz L200						
Nr 027689-649390 207D, 208D (311, 312, 316, 317, 361, 366)	ZWP-6626		0039P	WP-205	ZPL	105 105 0150
				WP-205	ZPP	105 105 0150
				WP-013	PL	105 105 0900
				WP-031	PP	105 105 2200
				WP-027	TL	105 105 1250
				WP-033	TP	105 105 0700
				WP-016	SP	105 105 2900
				0033T	WP-033	ST
Mercedes-Benz L200						
Nr 027689-649390 207D, 208D (318)	ZWP-6627		0039P	WP-205	ZPL	105 105 0150
				WP-205	ZPP	105 105 0150
				WP-013	PL	105 105 0900
				WP-031	PP	105 105 2200
				WP-027	TL	105 105 1250
				WP-033	TP	105 105 0700
				WP-029	SP	105 105 3200
				0033T	WP-033	ST
Mercedes-Benz L200						
Nr 027689-649390 207D, 208D (362, 367)	ZWP-6627		0039P	WP-205	ZPL	105 105 0150
				WP-205	ZPP	105 105 0150
				WP-013	PL	105 105 0900
				WP-031	PP	105 105 2200
				WP-027	TL	105 105 1250
				WP-033	TP	105 105 0700
				WP-029	SP	105 105 3200
				0033T	WP-033	ST
Mercedes-Benz L200						
Nr 027689-649390 208, 210 (011, 012, 016, 017, 061, 066)	ZWP-6626		0039P	WP-205	ZPL	105 105 0150
				WP-205	ZPP	105 105 0150
				WP-013	PL	105 105 0900
				WP-031	PP	105 105 2200
				WP-027	TL	105 105 1250
				WP-033	TP	105 105 0700
				WP-016	SP	105 105 2900
				0033T	WP-033	ST
Mercedes-Benz L200						
Nr 027689-649390 208, 210 (018)	ZWP-6627		0039P	WP-205	ZPL	105 105 0150
				WP-205	ZPP	105 105 0150
				WP-013	PL	105 105 0900
				WP-031	PP	105 105 2200
				WP-027	TL	105 105 1250
				WP-033	TP	105 105 0700
				WP-029	SP	105 105 3200
				0033T	WP-033	ST
Mercedes-Benz L200						
Nr 027689-649390 209D, 210D (411, 416, 461, 466)	ZWP-6625		0039P	WP-043	ZPL	105 105 0200
				WP-043	ZPP	105 105 0200
				WP-013	PL	105 105 0900
				WP-031	PP	105 105 2200
				WP-027	TL	105 105 1250
				WP-033	TP	105 105 0700
				WP-048	SP	105 105 2500
				0033T	WP-033	ST
Mercedes-Benz L200						
Nr 027689-649390 209D, 210D (412, 417)	ZWP-6624		0039P	WP-043	ZPL	105 105 0200
				WP-043	ZPP	105 105 0200
				WP-013	PL	105 105 0900
				WP-031	PP	105 105 2200
				WP-027	TL	105 105 1250
				WP-033	TP	105 105 0700
				WP-016	SP	105 105 2900
				0033T	WP-033	ST
Mercedes-Benz L200						
Nr 027689-649390 209D, 210D (418)	ZWP-6628		0039P	WP-043	ZPL	105 105 0200
				WP-043	ZPP	105 105 0200
				WP-013	PL	105 105 0900
				WP-031	PP	105 105 2200
				WP-027	TL	105 105 1250
				WP-033	TP	105 105 0700
				WP-020	SP	105 105 3400
				0033T	WP-033	ST
Mercedes-Benz L200						
Nr 027689-649390 209D, 210D (462, 467)	ZWP-6629		0039P	WP-043	ZPL	105 105 0200
				WP-043	ZPP	105 105 0200
				WP-013	PL	105 105 0900
				WP-031	PP	105 105 2200
				WP-027	TL	105 105 1250
				WP-033	TP	105 105 0700
				WP-004	SP	105 105 3100
				0033T	WP-033	ST

MARKA SAMOCHODU
CAR MODEL
МОДЕЛЬ АВТОМБИЯ

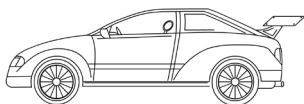

NUMER ZESTAWU
SET NUMBER
НОМЕР НАБОРА

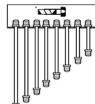

ROK PRODUKCJI
PRODUCTION YEAR
ГОД ВЫПУСКА АВТОМБИЯ



ODPOWIETRZNIK
BLEEDER SCREW
ШТУЦЕР ПРОКАЧКИ ТОРМОЗОВ



INDEKS
INDEX
ИНДЕКС



POŁOŻENIE
LOCATION
МЕСТО

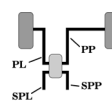

OPIS
DESCRIPTION
ОПИСАНИЕ

ZŁĄCZKA ZŁĄCZKA DŁUGOŚĆ
FITTING FITTING LENGTH
НАКОНЕЧНИК НАКОНЕЧНИК ДЛИНА

MARKA SAMOCHODU CAR MODEL МОДЕЛЬ АВТОМБИЯ	NUMER ZESTAWU SET NUMBER НОМЕР НАБОРА	ROK PRODUKCJI PRODUCTION YEAR ГОД ВЫПУСКА АВТОМБИЯ	ODPOWIETRZNIK BLEEDER SCREW ШТУЦЕР ПРОКАЧКИ ТОРМОЗОВ	INDEKS INDEX ИНДЕКС	POŁOŻENIE LOCATION МЕСТО	OPIS DESCRIPTION ОПИСАНИЕ
Mercedes-Benz L200						
Nr P000001-P006331 208, 210 (011, 012, 016, 017, 061, 066)	ZWP-6626		0039P	WP-205	ZPL	105 105 0150
				WP-205	ZPP	105 105 0150
				WP-013	PL	105 105 0900
				WP-031	PP	105 105 2200
				WP-027	TL	105 105 1250
				WP-033	TP	105 105 0700
				WP-016	SP	105 105 2900
				0033T	WP-033	ST
Mercedes-Benz L200						
Nr P000001-P006331 208, 210 (018)	ZWP-6627		0039P	WP-205	ZPL	105 105 0150
				WP-205	ZPP	105 105 0150
				WP-013	PL	105 105 0900
				WP-031	PP	105 105 2200
				WP-027	TL	105 105 1250
				WP-033	TP	105 105 0700
				WP-029	SP	105 105 3200
				0033T	WP-033	ST
Mercedes-Benz L200						
Nr P006332 208, 210 (011, 012, 016, 017)	ZWP-6626		0039P	WP-205	ZPL	105 105 0150
				WP-205	ZPP	105 105 0150
				WP-013	PL	105 105 0900
				WP-031	PP	105 105 2200
				WP-027	TL	105 105 1250
				WP-033	TP	105 105 0700
				WP-016	SP	105 105 2900
				0033T	WP-033	ST
Mercedes-Benz L200						
Nr P006332 208, 210 (018)	ZWP-6626		0039P	WP-205	ZPL	105 105 0150
				WP-205	ZPP	105 105 0150
				WP-013	PL	105 105 0900
				WP-031	PP	105 105 2200
				WP-027	TL	105 105 1250
				WP-033	TP	105 105 0700
				WP-016	SP	105 105 2900
				0033T	WP-033	ST
Mercedes-Benz L300						
Nr 027688, 649391-999999 307D, 308D (311, 312, 316, 317)	ZWP-6626		0039P	WP-205	ZPL	105 105 0150
				WP-205	ZPP	105 105 0150
				WP-013	PL	105 105 0900
				WP-031	PP	105 105 2200
				WP-027	TL	105 105 1250
				WP-033	TP	105 105 0700
				WP-016	SP	105 105 2900
				0033T	WP-033	ST
Mercedes-Benz L300						
Nr 027688, 649391-999999 307D, 308D (313, 318)	ZWP-6627		0039P	WP-205	ZPL	105 105 0150
				WP-205	ZPP	105 105 0150
				WP-013	PL	105 105 0900
				WP-031	PP	105 105 2200
				WP-027	TL	105 105 1250
				WP-033	TP	105 105 0700
				WP-029	SP	105 105 3200
				0033T	WP-033	ST
Mercedes-Benz L300						
Nr 027688, 649391-999999 307D, 308D (361, 366, 371, 376)	ZWP-6626		0039P	WP-205	ZPL	105 105 0150
				WP-205	ZPP	105 105 0150
				WP-013	PL	105 105 0900
				WP-031	PP	105 105 2200
				WP-027	TL	105 105 1250
				WP-033	TP	105 105 0700
				WP-016	SP	105 105 2900
				0033T	WP-033	ST
Mercedes-Benz L300						
Nr 027688, 649391-999999 307D, 308D (362, 367, 368, 372, 377)	ZWP-6627		0039P	WP-205	ZPL	105 105 0150
				WP-205	ZPP	105 105 0150
				WP-013	PL	105 105 0900
				WP-031	PP	105 105 2200
				WP-027	TL	105 105 1250
				WP-033	TP	105 105 0700
				WP-029	SP	105 105 3200
				0033T	WP-033	ST
Mercedes-Benz L300						
Nr 027688, 649391-999999 308, 310 (011, 012, 016, 017, 061, 062, 071, 076)	ZWP-6626		0039P	WP-205	ZPL	105 105 0150
				WP-205	ZPP	105 105 0150
				WP-013	PL	105 105 0900
				WP-031	PP	105 105 2200
				WP-027	TL	105 105 1250
				WP-033	TP	105 105 0700
				WP-016	SP	105 105 2900
				0033T	WP-033	ST

MARKA SAMOCHODU
CAR MODEL
МОДЕЛЬ АВТОМБИЯ

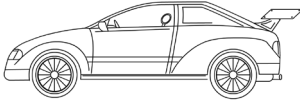

NUMER ZESTAWU
SET NUMBER
НОМЕР НАБОРА

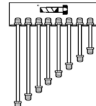

ROK PRODUKCJI
PRODUCTION YEAR
ГОД ВЫПУСКА АВТОМБИЯ



ODPOWIETRZNIK
BLEEDER SCREW
ШТУЦЕР ПРОКАЧКИ ТОРМОЗОВ

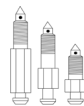

INDEKS
INDEX
ИНДЕКС



POŁOŻENIE
LOCATION
МЕСТО

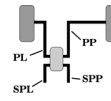

OPIS
DESCRIPTION
ОПИСАНИЕ

ZŁĄCZKA ZŁĄCZKA DŁUGOŚĆ
FITTING FITTING LENGTH
НАКОНЕЧНИК НАКОНЕЧНИК ДЛИНА

Mercedes-Benz L300						
Nr 027688, 649391-999999 308, 310 (013, 018, 062, 066, 072, 077)	ZWP-6627		0039P	WP-205	ZPL	105 105 0150
				WP-205	ZPP	105 105 0150
				WP-013	PL	105 105 0900
				WP-031	PP	105 105 2200
				WP-027	TL	105 105 1250
				WP-033	TP	105 105 0700
				WP-029	SP	105 105 3200
				0033T	WP-033	ST
Mercedes-Benz L300						
Nr 027688, 649391-999999 309D, 310D (411, 416, 461, 466, 471, 476)	ZWP-6625		0039P	WP-043	ZPL	105 105 0200
				WP-043	ZPP	105 105 0200
				WP-013	PL	105 105 0900
				WP-031	PP	105 105 2200
				WP-027	TL	105 105 1250
				WP-033	TP	105 105 0700
				WP-048	SP	105 105 2500
				0033T	WP-033	ST
Mercedes-Benz L300						
Nr 027688, 649391-999999 309D, 310D (412, 417)	ZWP-6624		0039P	WP-043	ZPL	105 105 0200
				WP-043	ZPP	105 105 0200
				WP-013	PL	105 105 0900
				WP-031	PP	105 105 2200
				WP-027	TL	105 105 1250
				WP-033	TP	105 105 0700
				WP-016	SP	105 105 2900
				0033T	WP-033	ST
Mercedes-Benz L300						
Nr 027688, 649391-999999 309D, 310D (413, 418)	ZWP-6628		0039P	WP-043	ZPL	105 105 0200
				WP-043	ZPP	105 105 0200
				WP-013	PL	105 105 0900
				WP-031	PP	105 105 2200
				WP-027	TL	105 105 1250
				WP-033	TP	105 105 0700
				WP-020	SP	105 105 3400
				0033T	WP-033	ST
Mercedes-Benz L300						
Nr 027688, 649391-999999 309D, 310D (462, 467, 472, 477, 487)	ZWP-6629		0039P	WP-043	ZPL	105 105 0200
				WP-043	ZPP	105 105 0200
				WP-013	PL	105 105 0900
				WP-031	PP	105 105 2200
				WP-027	TL	105 105 1250
				WP-033	TP	105 105 0700
				WP-004	SP	105 105 3100
				0033T	WP-033	ST
Mercedes-Benz L300						
Nr 027688, 649391-999999 309D, 310D (468)	ZWP-6623		0039P	WP-043	ZPL	105 105 0200
				WP-043	ZPP	105 105 0200
				WP-013	PL	105 105 0900
				WP-031	PP	105 105 2200
				WP-027	TL	105 105 1250
				WP-033	TP	105 105 0700
				WP-029	SP	105 105 3200
				0033T	WP-033	ST
Mercedes-Benz L300						
Nr 027689-649390 307D, 308D (311, 312, 316, 317, 361, 366, 374, 376)	ZWP-6626		0039P	WP-205	ZPL	105 105 0150
				WP-205	ZPP	105 105 0150
				WP-013	PL	105 105 0900
				WP-031	PP	105 105 2200
				WP-027	TL	105 105 1250
				WP-033	TP	105 105 0700
				WP-016	SP	105 105 2900
				0033T	WP-033	ST
Mercedes-Benz L300						
Nr 027689-649390 307D, 308D (313, 318, 362, 367, 368, 372, 377)	ZWP-6627		0039P	WP-205	ZPL	105 105 0150
				WP-205	ZPP	105 105 0150
				WP-013	PL	105 105 0900
				WP-031	PP	105 105 2200
				WP-027	TL	105 105 1250
				WP-033	TP	105 105 0700
				WP-029	SP	105 105 3200
				0033T	WP-033	ST
Mercedes-Benz L300						
Nr 027689-649390 308, 310 (011, 012, 016, 017, 061, 066, 071, 076)	ZWP-6626		0039P	WP-205	ZPL	105 105 0150
				WP-205	ZPP	105 105 0150
				WP-013	PL	105 105 0900
				WP-031	PP	105 105 2200
				WP-027	TL	105 105 1250
				WP-033	TP	105 105 0700
				WP-016	SP	105 105 2900
				0033T	WP-033	ST

MARKA SAMOCHODU
CAR MODEL
МОДЕЛЬ АВТОМБИЯ

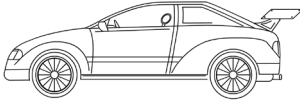

NUMER ZESTAWU
SET NUMBER
НОМЕР НАБОРА

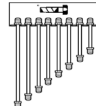

ROK PRODUKCJI
PRODUCTION YEAR
ГОД ВЫПУСКА АВТОМБИЯ



ODPOWIETRZNIK
BLEEDER SCREW
ШТУЦЕР ПРОКАЧКИ ТОРМОЗОВ

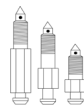

INDEKS
INDEX
ИНДЕКС



POŁOŻENIE
LOCATION
МЕСТО

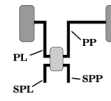

OPIS
DESCRIPTION
ОПИСАНИЕ

ZŁĄCZKA
FITTING
НАКОНЕЧНИК

ZŁĄCZKA
FITTING
НАКОНЕЧНИК

DŁUGOŚĆ
LENGTH
ДЛИНА

Mercedes-Benz L300						
Nr 027689-649390 308, 310 (013, 018, 062, 067, 072, 077)	ZWP-6627		0039P	WP-205	ZPL	105 105 0150
				WP-205	ZPP	105 105 0150
				WP-013	PL	105 105 0900
				WP-031	PP	105 105 2200
				WP-027	TL	105 105 1250
				WP-033	TP	105 105 0700
				WP-029	SP	105 105 3200
				0033T	WP-033	ST
Mercedes-Benz L300						
Nr 027689-649390 309D, 310D (411, 416, 461, 466, 471, 476)	ZWP-6625		0039P	WP-043	ZPL	105 105 0200
				WP-043	ZPP	105 105 0200
				WP-013	PL	105 105 0900
				WP-031	PP	105 105 2200
				WP-027	TL	105 105 1250
				WP-033	TP	105 105 0700
				WP-048	SP	105 105 2500
				0033T	WP-033	ST
Mercedes-Benz L300						
Nr 027689-649390 309D, 310D (412, 417)	ZWP-6624		0039P	WP-043	ZPL	105 105 0200
				WP-043	ZPP	105 105 0200
				WP-013	PL	105 105 0900
				WP-031	PP	105 105 2200
				WP-027	TL	105 105 1250
				WP-033	TP	105 105 0700
				WP-016	SP	105 105 2900
				0033T	WP-033	ST
Mercedes-Benz L300						
Nr 027689-649390 309D, 310D (413, 418)	ZWP-6628		0039P	WP-043	ZPL	105 105 0200
				WP-043	ZPP	105 105 0200
				WP-013	PL	105 105 0900
				WP-031	PP	105 105 2200
				WP-027	TL	105 105 1250
				WP-033	TP	105 105 0700
				WP-020	SP	105 105 3400
				0033T	WP-033	ST
Mercedes-Benz L300						
Nr 027689-649390 309D, 310D (462, 467, 472, 477, 487)	ZWP-6629		0039P	WP-043	ZPL	105 105 0200
				WP-043	ZPP	105 105 0200
				WP-013	PL	105 105 0900
				WP-031	PP	105 105 2200
				WP-027	TL	105 105 1250
				WP-033	TP	105 105 0700
				WP-004	SP	105 105 3100
				0033T	WP-033	ST
Mercedes-Benz L300						
Nr 027689-649390 309D, 310D (468)	ZWP-6623		0039P	WP-043	ZPL	105 105 0200
				WP-043	ZPP	105 105 0200
				WP-013	PL	105 105 0900
				WP-031	PP	105 105 2200
				WP-027	TL	105 105 1250
				WP-033	TP	105 105 0700
				WP-029	SP	105 105 3200
				0033T	WP-033	ST
Mercedes-Benz L300						
Nr P000001-P006331 307D, 308D (311, 312, 316, 317)	ZWP-6626		0039P	WP-205	ZPL	105 105 0150
				WP-205	ZPP	105 105 0150
				WP-013	PL	105 105 0900
				WP-031	PP	105 105 2200
				WP-027	TL	105 105 1250
				WP-033	TP	105 105 0700
				WP-016	SP	105 105 2900
				0033T	WP-033	ST
Mercedes-Benz L300						
Nr P000001-P006331 307D, 308D (313, 318)	ZWP-6627		0039P	WP-205	ZPL	105 105 0150
				WP-205	ZPP	105 105 0150
				WP-013	PL	105 105 0900
				WP-031	PP	105 105 2200
				WP-027	TL	105 105 1250
				WP-033	TP	105 105 0700
				WP-029	SP	105 105 3200
				0033T	WP-033	ST
Mercedes-Benz L300						
Nr P000001-P006331 307D, 308D (013, 018)	ZWP-6627		0039P	WP-205	ZPL	105 105 0150
				WP-205	ZPP	105 105 0150
				WP-013	PL	105 105 0900
				WP-031	PP	105 105 2200
				WP-027	TL	105 105 1250
				WP-033	TP	105 105 0700
				WP-029	SP	105 105 3200
				0033T	WP-033	ST

MARKA SAMOCHODU
CAR MODEL
МОДЕЛЬ АВТОМБИЯ

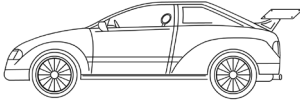

NUMER ZESTAWU
SET NUMBER
НОМЕР НАБОРА

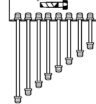

ROK PRODUKCJI
PRODUCTION YEAR
ГОД ВЫПУСКА АВТОМБИЯ



ODPOWIETRZNIK
BLEEDER SCREW
ШТУЦЕР ПРОКАЧКИ ТОРМОЗОВ

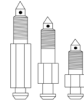

INDEKS
INDEX
ИНДЕКС



POŁOŻENIE
LOCATION
МЕСТО

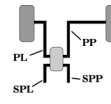

OPIS
DESCRIPTION
ОПИСАНИЕ

ZŁĄCZKA ZŁĄCZKA DŁUGOŚĆ
FITTING FITTING LENGTH
НАКОНЕЧНИК НАКОНЕЧНИК ДЛИНА

Mercedes-Benz L300						
Nr P006332 307D, 308D (311, 312, 316, 317)	ZWP-6626		0039P	WP-205	ZPL	105 105 0150
				WP-205	ZPP	105 105 0150
				WP-013	PL	105 105 0900
				WP-031	PP	105 105 2200
				WP-027	TL	105 105 1250
				WP-033	TP	105 105 0700
				WP-016	SP	105 105 2900
				WP-033	ST	105 105 0700
				0033T		
Mercedes-Benz L300						
Nr P006332 307D, 308D (313, 318)	ZWP-6627		0039P	WP-205	ZPL	105 105 0150
				WP-205	ZPP	105 105 0150
				WP-013	PL	105 105 0900
				WP-031	PP	105 105 2200
				WP-027	TL	105 105 1250
				WP-033	TP	105 105 0700
				WP-029	SP	105 105 3200
				WP-033	ST	105 105 0700
				0033T		
Mercedes-Benz L300						
Nr P006332 307, 308 (011, 012, 016, 017)	ZWP-6626		0039P	WP-205	ZPL	105 105 0150
				WP-205	ZPP	105 105 0150
				WP-013	PL	105 105 0900
				WP-031	PP	105 105 2200
				WP-027	TL	105 105 1250
				WP-033	TP	105 105 0700
				WP-016	SP	105 105 2900
				WP-033	ST	105 105 0700
				0033T		
Mercedes-Benz L300						
Nr P006332 307, 308 (013, 018)	ZWP-6627		0039P	WP-205	ZPL	105 105 0150
				WP-205	ZPP	105 105 0150
				WP-013	PL	105 105 0900
				WP-031	PP	105 105 2200
				WP-027	TL	105 105 1250
				WP-033	TP	105 105 0700
				WP-029	SP	105 105 3200
				WP-033	ST	105 105 0700
				0033T		
Mercedes-Benz L300						
Nr 625656 307D, 308D (382(BUS))	ZWP-6623		0039P	WP-043	ZPL	105 105 0200
				WP-043	ZPP	105 105 0200
				WP-013	PL	105 105 0900
				WP-031	PP	105 105 2200
				WP-027	TL	105 105 1250
				WP-033	TP	105 105 0700
				WP-029	SP	105 105 3200
				WP-033	ST	105 105 0700
				0033T		
Mercedes-Benz L300						
Nr 625656 308, 310 (082)	ZWP-6624		0039P	WP-043	ZPL	105 105 0200
				WP-043	ZPP	105 105 0200
				WP-013	PL	105 105 0900
				WP-031	PP	105 105 2200
				WP-027	TL	105 105 1250
				WP-033	TP	105 105 0700
				WP-016	SP	105 105 2900
				WP-033	ST	105 105 0700
				0033T		
Mercedes-Benz L400						
Nr 999999, P000001-P006331 407D, 408D, 409D, 410 (017, 067, 317, 367, 417, 467)	ZWP-6630		0039P	WP-043	ZPL	105 105 0200
				WP-043	ZPP	105 105 0200
				WP-013	PL	105 105 0900
				WP-031	PP	105 105 2200
				WP-027	TL	105 105 1250
				WP-009	TP	105 105 0600
				WP-004	SP	105 105 3100
				WP-117	ST	105 105 0750
				0039P		
Mercedes-Benz L400						
Nr P006332 407D, 408D, 409D, 410 (017, 067, 317, 367, 417, 467)	ZWP-6630		0039P	WP-043	ZPL	105 105 0200
				WP-043	ZPP	105 105 0200
				WP-013	PL	105 105 0900
				WP-031	PP	105 105 2200
				WP-027	TL	105 105 1250
				WP-009	TP	105 105 0600
				WP-004	SP	105 105 3100
				WP-117	ST	105 105 0750
				0039P		
Mercedes-Benz L400						
Nr 999999, P000001-P006331 407D, 408D, 409D, 410 (018, 318, 418)	ZWP-6631		0039P	WP-043	ZPL	105 105 0200
				WP-043	ZPP	105 105 0200
				WP-013	PL	105 105 0900
				WP-031	PP	105 105 2200
				WP-027	TL	105 105 1250
				WP-009	TP	105 105 0600
				WP-020	SP	105 105 3400
				WP-117	ST	105 105 0750
				0039P		

MARKA SAMOCHODU
CAR MODEL
МОДЕЛЬ АВТОМБИЯ

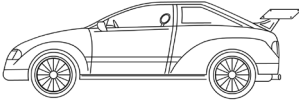

NUMER ZESTAWU
SET NUMBER
НОМЕР НАБОРА

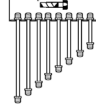

ROK PRODUKCJI
PRODUCTION YEAR
ГОД ВЫПУСКА АВТОМБИЯ



ODPOWIETRZNIK
BLEEDER SCREW
ШТУЦЕР ПРОКАЧКИ ТОРМОЗОВ

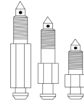

INDEKS
INDEX
ИНДЕКС



POŁOŻENIE
LOCATION
МЕСТО

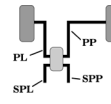

OPIS
DESCRIPTION
ОПИСАНИЕ

ZŁĄCZKA ZŁĄCZKA DŁUGOŚĆ
FITTING FITTING LENGTH
НАКОНЕЧНИК НАКОНЕЧНИК ДЛИНА

MARKA SAMOCHODU CAR MODEL МОДЕЛЬ АВТОМБИЯ	NUMER ZESTAWU SET NUMBER НОМЕР НАБОРА	ROK PRODUKCJI PRODUCTION YEAR ГОД ВЫПУСКА АВТОМБИЯ	ODPOWIETRZNIK BLEEDER SCREW ШТУЦЕР ПРОКАЧКИ ТОРМОЗОВ	INDEKS INDEX ИНДЕКС	POŁOŻENIE LOCATION МЕСТО	OPIS DESCRIPTION ОПИСАНИЕ	
Mercedes-Benz L400							
Nr P006332 407D, 408D, 410 (018, 318, 418)	ZWP-6631		0039P	WP-043	ZPL	105 105 0200	
				WP-043	ZPP	105 105 0200	
				WP-013	PL	105 105 0900	
				WP-031	PP	105 105 2200	
				WP-027	TL	105 105 1250	
				WP-009	TP	105 105 0600	
				WP-020	SP	105 105 3400	
				WP-117	ST	105 105 0750	
Mercedes-Benz L400							
Nr 999999, P000001-P006331 407D, 408D, 409D, 410 (068, 368, 468)	ZWP-6632		0039P	WP-043	ZPL	105 105 0200	
				WP-043	ZPP	105 105 0200	
				WP-013	PL	105 105 0900	
				WP-031	PP	105 105 2200	
				WP-027	TL	105 105 1250	
				WP-009	TP	105 105 0600	
				WP-021	SP	105 105 3600	
				WP-117	ST	105 105 0750	
Mercedes-Benz L400							
Nr P006332 407D, 408D, 409D, 410 (068, 368, 468)	ZWP-6632		0039P	WP-043	ZPL	105 105 0200	
				WP-043	ZPP	105 105 0200	
				WP-013	PL	105 105 0900	
				WP-031	PP	105 105 2200	
				WP-027	TL	105 105 1250	
				WP-009	TP	105 105 0600	
				WP-021	SP	105 105 3600	
				WP-117	ST	105 105 0750	
Mercedes-Benz MB-100							
Nr 066362 332, 333, 334	ZWP-6633	09.87>90	0039P	WP-043	PL	105 105 0200	
				WP-006	PL+	105 105 0250	
				WP-034	PP	105 105 1200	
				WP-034	PP+	105 105 1200	
				WP-034	TL	105 105 1200	
				WP-033	TP	105 105 0700	
				0086T	WP-008	CC	105 105 3000
Mercedes-Benz MB-100							
Nr 066363-097945 332, 333, 334	ZWP-6634	91>	0039P	WP-043	PL	105 105 0200	
				WP-001	PL+	105 105 0300	
				WP-252	PP	105 105 1050	
				WP-034	PP+	105 105 1200	
				WP-034	TL	105 105 1200	
				WP-033	TP	105 105 0700	
				0086T	WP-016	CC	105 105 2900
Mercedes-Benz MB-100							
Nr 097946 332, 333, 334	ZWP-6635	92>	0039P	WP-006	PL	105 105 0250	
				WP-006	PL+	105 105 0250	
				WP-019	PP	105 105 1000	
				WP-252	PP+	105 105 1050	
				WP-034	TL	105 105 1200	
				WP-033	TP	105 105 0700	
				0086T	WP-016	CC	105 105 2900
Mercedes-Benz MB-100							
Nr 066362 342, 343, 344	ZWP-6636	09.87>90	0039P	WP-043	PL	105 105 0200	
				WP-006	PL+	105 105 0250	
				WP-034	PP	105 105 1200	
				WP-034	PP+	105 105 1200	
				WP-034	TL	105 105 1200	
				WP-033	TP	105 105 0700	
				0086T	WP-709	CC	105 105 3150
Mercedes-Benz MB-100							
Nr 066363-097945 342, 343, 344	ZWP-6634	91>	0039P	WP-043	PL	105 105 0200	
				WP-001	PL+	105 105 0300	
				WP-252	PP	105 105 1050	
				WP-034	PP+	105 105 1200	
				WP-034	TL	105 105 1200	
				WP-033	TP	105 105 0700	
				0086T	WP-016	CC	105 105 2900
Mercedes-Benz MB-100							
Nr 097946 342, 343, 344	ZWP-6638	92>	0039P	WP-006	PL	105 105 0250	
				WP-006	PL	105 105 0250	
				WP-019	PP	105 105 1000	
				WP-252	PP+	105 105 1050	
				WP-034	TL	105 105 1200	
				WP-033	TP	105 105 0700	
				0086T	WP-004	CC	105 105 3100

MARKA SAMOCHODU
CAR MODEL
МОДЕЛЬ АВТОМБИЛЯ

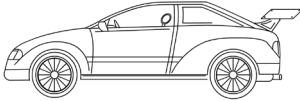

NUMER ZESTAWU
SET NUMBER
НОМЕР НАБОРА

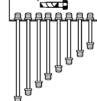

ROK PRODUKCJI
PRODUCTION YEAR
ГОД ВЫПУСКА АВТОМБИЛЯ



ODPOWIETRZNIK
BLEEDER SCREW
ШТУЦЕР ПРОКАЧКИ ТОРМОЗОВ

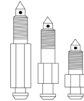

INDEKS
INDEX
ИНДЕКС



POŁOŻENIE
LOCATION
МЕСТО

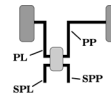

OPIS
DESCRIPTION
ОПИСАНИЕ

ZŁĄCZKA
FITTING
НАКОНЕЧНИК

ZŁĄCZKA
FITTING
НАКОНЕЧНИК

DŁUGOŚĆ
LENGTH
ДЛИНА

MARKA SAMOCHODU CAR MODEL МОДЕЛЬ АВТОМБИЛЯ	NUMER ZESTAWU SET NUMBER НОМЕР НАБОРА	ROK PRODUKCJI PRODUCTION YEAR ГОД ВЫПУСКА АВТОМБИЛЯ	ODPOWIETRZNIK BLEEDER SCREW ШТУЦЕР ПРОКАЧКИ ТОРМОЗОВ	INDEKS INDEX ИНДЕКС	POŁOŻENIE LOCATION МЕСТО	OPIS DESCRIPTION ОПИСАНИЕ
Mercedes Sprinter (BM901/902/903)						
Wszystkie modele, bez ABS, rozstaw osi 3000 mm All models, without ABS, wheel base 3000 mm Все модели, без ABS, колесная база 3000 мм	ZWP-6639	02.95>12.02	0039P 0011P	WP-018	PL	105 105 0650
				WP-435	PP	105 105 1600
				WP-167	CL	105 105 2600
				WP-004	CP	105 105 3100
				WP-009	TL	105 105 0600
			0039T	WP-003	TP	105 105 1400
Mercedes Sprinter (BM901/902/903)						
Wszystkie modele, bez ABS, rozstaw osi 3550 mm All models, without ABS, wheel base 3550 mm Все модели, без ABS, колесная база 3550 мм	ZWP-6639	02.95>12.02	0039P 0011P	WP-018	PL	105 105 0650
				WP-435	PP	105 105 1600
				WP-167	CL	105 105 2600
				WP-004	CP	105 105 3100
				WP-009	TL	105 105 0600
			0039T	WP-003	TP	105 105 1400
Mercedes Sprinter (BM901/902/903)						
Wszystkie modele, bez ABS, rozstaw osi 4025 mm All models, without ABS, wheel base 4025 mm Все модели, без ABS, колесная база 4025 мм	ZWP-6643	02.95>12.02	0039P 0011P	WP-018	PL	105 105 0650
				WP-435	PP	105 105 1600
				WP-571	CL	105 105 3850
				WP-021	CP	105 105 3600
				WP-009	TL	105 105 0600
			0039T	WP-003	TP	105 105 1400
Mercedes Sprinter (BM901/902/903)						
Wszystkie modele, bez CDI, z ABS All models, without CDI, with ABS Все модели, без CDI, with ABS rozstaw osi 3000 mm, pojedyncze koła wheel base 3000 mm, single wheel колесная база 3000 мм, одно колесо -ch.P718186	ZWP-6640	02.95>12.02	0039P 0011P	WP-018	PL	105 105 0650
				WP-435	PP	105 105 1600
				WP-196	SPL	105 105 1300
				WP-196	SPP	105 105 1300
				WP-428	STL	105 105 2050
				WP-036	STP	105 105 2100
				WP-009	TL	105 105 0600
				0039T	WP-003	TP
Mercedes Sprinter (BM901/902/903)						
Wszystkie modele, bez CDI, z ABS All models, without CDI, with ABS Все модели, без CDI, with ABS rozstaw osi 3000 mm, pojedyncze koła wheel base 3000 mm, single wheel колесная база 3000 мм, одно колесо ch.P718187-, R000001-	ZWP-6686	02.95>12.02	0039P 0011P	WP-018	PL	105 105 0650
				WP-435	PP	105 105 1600
				WP-1863	SPL	105 110X 1450
				WP-1864	SPP	105 110X 1500
				WP-428	STL	105 105 2050
				WP-036	STP	105 105 2100
				WP-009	TL	105 105 0600
				0039T	WP-003	TP
Mercedes Sprinter (BM901/902/903)						
Wszystkie modele, CDI, z ABS All models, CDI, with ABS Все модели, CDI, with ABS rozstaw osi 3000 mm, pojedyncze koła wheel base 3000 mm, single wheel колесная база 3000 мм, одно колесо	ZWP-6687	02.95>12.02	0039P 0011P	WP-018	PL	105 105 0650
				WP-1865	PP	105 110X 1550
				WP-1864	SPL	105 110X 1500
				WP-842	SPP	105 110X 1400
				WP-428	STL	105 105 2050
				WP-036	STP	105 105 2100
				WP-009	TL	105 105 0600
				0039T	WP-003	TP
Mercedes Sprinter (BM901/902/903)						
Wszystkie modele, bez CDI, z ABS All models, without CDI, with ABS Все модели, без CDI, with ABS rozstaw osi 3550 mm, pojedyncze koła wheel base 3550 mm, single wheel колесная база 3550 мм, одно колесо -ch.P718186	ZWP-6642	02.95>12.02	0039P 0011P	WP-018	PL	105 105 0650
				WP-435	PP	105 105 1600
				WP-196	SPL	105 105 1300
				WP-196	SPP	105 105 1300
				WP-048	STL	105 105 2500
				WP-167	STP	105 105 2600
				WP-009	TL	105 105 0600
				0039T	WP-003	TP
Mercedes Sprinter (BM901/902/903)						
Wszystkie modele, bez CDI, z ABS All models, without CDI, with ABS Все модели, без CDI, with ABS rozstaw osi 3550 mm, pojedyncze koła wheel base 3550 mm, single wheel колесная база 3550 мм, одно колесо ch.P718187-, R000001-	ZWP-6689	02.95>12.02	0039P 0011P	WP-018	PL	105 105 0650
				WP-435	PP	105 105 1600
				WP-1863	SPL	105 110X 1450
				WP-1864	SPP	105 110X 1500
				WP-048	STL	105 105 2500
				WP-707	STP	105 105 2650
				WP-009	TL	105 105 0600
				0039T	WP-003	TP
Mercedes Sprinter (BM901/902/903)						
Wszystkie modele, CDI, z ABS All models, CDI, with ABS Все модели, CDI, with ABS rozstaw osi 3550 mm, pojedyncze koła wheel base 3550 mm, single wheel колесная база 3550 мм, одно колесо	ZWP-6690	02.95>12.02	0039P 0011P	WP-018	PL	105 105 0650
				WP-1865	PP	105 110X 1550
				WP-1864	SPL	105 110X 1500
				WP-842	SPP	105 110X 1400
				WP-048	STL	105 105 2500
				WP-707	STP	105 105 2650
				WP-009	TL	105 105 0600
				0039T	WP-003	TP

MARKA SAMOCHODU
CAR MODEL
МОДЕЛЬ АВТОМБИЛЯ

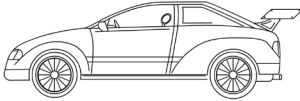

NUMER ZESTAWU
SET NUMBER
НОМЕР НАБОРА

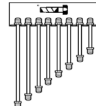

ROK PRODUKCJI
PRODUCTION YEAR
ГОД ВЫПУСКА АВТОМБИЛЯ



ODPOWIETRZNIK
BLEEDER SCREW
ШТУЦЕР ПРОКАЧКИ ТОРМОЗОВ

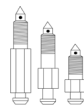

INDEKS
INDEX
ИНДЕКС



POŁOŻENIE
LOCATION
МЕСТО

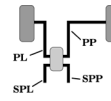

OPIS
DESCRIPTION
ОПИСАНИЕ

ZŁĄCZKA
FITTING
НАКОНЕЧНИК

ZŁĄCZKA
FITTING
НАКОНЕЧНИК

DŁUGOŚĆ
LENGTH
ДЛИНА

MARKA SAMOCHODU CAR MODEL МОДЕЛЬ АВТОМБИЛЯ	NUMER ZESTAWU SET NUMBER НОМЕР НАБОРА	ROK PRODUKCJI PRODUCTION YEAR ГОД ВЫПУСКА АВТОМБИЛЯ	ODPOWIETRZNIK BLEEDER SCREW ШТУЦЕР ПРОКАЧКИ ТОРМОЗОВ	INDEKS INDEX ИНДЕКС	POŁOŻENIE LOCATION МЕСТО	OPIS DESCRIPTION ОПИСАНИЕ
Mercedes Sprinter (BM901/902/903)						
Wszystkie modele, bez CDI, z ABS All models, without CDI, with ABS Все модели, без CDI, with ABS rozstaw osi 4025 mm, pojedyncze koła wheel base 4025 mm, single wheel колесная база 4025 мм, одно колесо -ch.P718186	ZWP-6644	02.95>12.02	0039P 0011P 0039T	WP-018	PL	105 105 0650
				WP-435	PP	105 105 1600
				WP-196	SPL	105 105 1300
				WP-196	SPP	105 105 1300
				WP-004	STL	105 105 3100
				WP-004	STP	105 105 3100
				WP-009	TL	105 105 0600
				WP-003	TP	105 105 1400
				Mercedes Sprinter (BM901/902/903)		
Wszystkie modele, bez CDI, z ABS All models, without CDI, with ABS Все модели, без CDI, with ABS rozstaw osi 4025 mm, pojedyncze koła wheel base 4025 mm, single wheel колесная база 4025 мм, одно колесо ch.P718187-,R000001-	ZWP-6692	02.95>12.02	0039P 0011P 0039T	WP-009	PL	105 105 0600
				WP-435	PP	105 105 1600
				WP-1863	SPL	105 110X 1450
				WP-1864	SPP	105 110X 1500
				WP-004	STL	105 105 3100
				WP-004	STP	105 105 3100
				WP-009	TL	105 105 0600
				WP-003	TP	105 105 1400
				Mercedes Sprinter (BM901/902/903)		
Wszystkie modele, CDI, z ABS All models, CDI, with ABS Все модели, CDI, with ABS rozstaw osi 4025 mm, pojedyncze koła wheel base 4025 mm, single wheel колесная база 4025 мм, одно колесо	ZWP-6693	02.95>12.02	0039P 0011P 0039T	WP-018	PL	105 105 0650
				WP-1865	PP	105 110X 1550
				WP-1864	SPL	105 110X 1500
				WP-842	SPP	105 110X 1400
				WP-004	STL	105 105 3100
				WP-029	STP	105 105 3200
				WP-009	TL	105 105 0600
				WP-003	TP	105 105 1400
				Mercedes Sprinter (BM901/902/903)		
Wszystkie modele, bez CDI, z ABS All models, without CDI, with ABS Все модели, без CDI, with ABS rozstaw osi 3000 mm, podwójne koła wheel base 3000 mm, dual wheels колесная база 3000 мм, двояными колесами -ch.P718186	ZWP-6694	02.95>12.02	0039P 0011P 0039T	WP-018	PL	105 105 0650
				WP-435	PP	105 105 1600
				WP-196	SPL	105 105 1300
				WP-196	SPP	105 105 1300
				WP-428	STL	105 105 2050
				WP-036	STP	105 105 2100
				WP-045	TL	105 105 0400
				WP-019	TP	105 105 1000
				Mercedes Sprinter (BM901/902/903)		
Wszystkie modele, bez CDI, z ABS All models, without CDI, with ABS Все модели, без CDI, with ABS rozstaw osi 3550 mm, podwójne koła wheel base 3550 mm, dual wheels колесная база 3550 мм, двояными колесами -ch.P718186	ZWP-6695	02.95>12.02	0039P 0011P 0039T	WP-018	PL	105 105 0650
				WP-435	PP	105 105 1600
				WP-196	SPL	105 105 1300
				WP-196	SPP	105 105 1300
				WP-048	STL	105 105 2500
				WP-167	STP	105 105 2600
				WP-045	TL	105 105 0400
				WP-019	TP	105 105 1000
				Mercedes Sprinter (BM901/902/903)		
Wszystkie modele, bez CDI, z ABS All models, without CDI, with ABS Все модели, без CDI, with ABS rozstaw osi 3550 mm, podwójne koła wheel base 3550 mm, dual wheels колесная база 3550 мм, двояными колесами -ch.P718186	ZWP-6696	02.95>12.02	0039P 0011P 0039T	WP-018	PL	105 105 0650
				WP-435	PP	105 105 1600
				WP-196	SPL	105 105 1300
				WP-196	SPP	105 105 1300
				WP-004	STL	105 105 3100
				WP-004	STP	105 105 3100
				WP-045	TL	105 105 0400
				WP-019	TP	105 105 1000
				Mercedes Sprinter (BM901/902)		
rozstaw osi 3000 mm, bez ABS wheel base 3000 mm, without ABS колесная база 3000 мм, без ABS	ZWP-6639	02.95>12.02	0039P 0011P 0039T	WP-018	PL	105 105 0650
				WP-435	PP	105 105 1600
				WP-009	TL	105 105 0600
				WP-003	TP	105 105 1400
				WP-167	CL	105 105 2600
				WP-004	CP	105 105 3100
Mercedes Sprinter (BM901/902)						
rozstaw osi 3000 mm, z ABS wheel base 3000 mm, with ABS колесная база 3000 мм, с ABS pojedyncze koła single wheel одно колесо	ZWP-6640	02.95>12.02	0039P 0011P 0039T	WP-018	PL	105 105 0650
				WP-435	PP	105 105 1600
				WP-009	TL	105 105 0600
				WP-003	TP	105 105 1400
				WP-196	SPL	105 105 1300
				WP-196	SPP	105 105 1300
				WP-036	STP	105 105 2100
Mercedes Sprinter (BM901/902)						
rozstaw osi 3550 mm, bez ABS wheel base 3550 mm, without ABS колесная база 3550 мм, без ABS	ZWP-6639	02.95>	0039P 0011P 0039T	WP-018	PL	105 105 0650
				WP-435	PP	105 105 1600
				WP-009	TL	105 105 0600
				WP-003	TP	105 105 1400
				WP-167	CL	105 105 2600
				WP-004	CP	105 105 3100

MARKA SAMOCHODU
CAR MODEL
МОДЕЛЬ АВТОМБИЯ

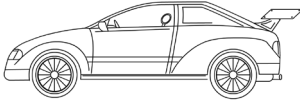

NUMER ZESTAWU
SET NUMBER
НОМЕР НАБОРА

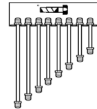

ROK PRODUKCJI
PRODUCTION YEAR
ГОД ВЫПУСКА АВТОМБИЯ



ODPOWIETRZNIK
BLEEDER SCREW
ШТУЦЕР ПРОКАЧКИ ТОРМОЗОВ

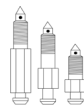

INDEKS
INDEX
ИНДЕКС



POŁOŻENIE
LOCATION
МЕСТО

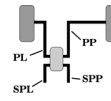

OPIS
DESCRIPTION
ОПИСАНИЕ

ZŁĄCZKA
FITTING
НАКОНЕЧНИК

ZŁĄCZKA
FITTING
НАКОНЕЧНИК

DŁUGOŚĆ
LENGTH
ДЛИНА

Mercedes Sprinter (BM901/902)	ZWP-6642	02.95>	0039P 0011P 0039T	WP-018 WP-435 WP-009 WP-003 WP-196 WP-196 WP-048 WP-167	PL PP TL TP SPL SPP STL STP	105 105 0650 105 105 1600 105 105 0600 105 105 1400 105 105 1300 105 105 1300 105 105 2500 105 105 2600
rozstaw osi 3550 mm, z ABS wheel base 3550 mm, with ABS колесная база 3550 мм, с ABS pojedyncze koła single wheel одно колесо						
Mercedes Sprinter (BM901/902)	ZWP-6643	02.95>	0039P 0011P 0039T	WP-018 WP-435 WP-009 WP-003 WP-571 WP-021	PL PP TL TP CL CP	105 105 0650 105 105 1600 105 105 0600 105 105 1400 105 105 3850 105 105 3600
rozstaw osi 4025 mm, bez ABS wheel base 4025 mm, without ABS колесная база 4025 мм, без ABS						
Mercedes Sprinter (BM901/902)	ZWP-6644	02.95>	0039P 0011P 0039T	WP-018 WP-435 WP-009 WP-003 WP-196 WP-196 WP-004 WP-004	PL PP TL TP SPL SPP STL STP	105 105 0650 105 105 1600 105 105 0600 105 105 1400 105 105 1300 105 105 1300 105 105 3100 105 105 3100
rozstaw osi 4025 mm, z ABS wheel base 4025 mm, with ABS колесная база 4025 мм, с ABS						
Mercedes Vaneo	ZWP-6645	02.02>	0039P 0011P	WP-017 WP-435 WP-028 WP-028 WP-475 WP-253	PL PP TL TP CL CP	105 105 0500 105 105 1600 105 105 0550 105 105 0550 105 105 3050 105 105 4200
Wszystkie modele All models Все модели						
Mercedes Vito (BM638)	ZWP-6646	12.96>	0039P 0086T	WP-024 WP-048 WP-257 WP-257	PL PP CL CP	105 105 0800 105 105 2500 105 105 4500 105 105 4500
108, 110, 113, 114, z ABS with ABS с ABS *71						
Mercedes Vito (BM638)	ZWP-6647	12.96>	0039P 0086T	WP-002 WP-048 WP-007 WP-007 WP-196 WP-115	PL PP CL CP TL TP	105 105 0850 105 105 2500 105 105 3900 105 105 3900 105 105 1300 105 105 1150
108, 110, 113, 114 bez ABS without ABS без ABS *72						
Mercedes Vito (BM638)	ZWP-6648	12.96>	0039P 0086T	WP-024 WP-031 WP-571 WP-030 WP-003 WP-027	PL PP CL CP TL TP	105 105 0800 105 105 2200 105 105 3850 105 105 3700 105 105 1400 105 105 1250
108, 110, 113, 114 z ABS with ABS с ABS *72						
Mercedes Vito (BM638)	ZWP-6649	03.99>	0039P 0086T 0039T	WP-252 WP-048 WP-392 WP-392	PL PP CL CP	105 105 1050 105 105 2500 105 105 5000 105 105 5000
108 CDI, 110 CDI, 112 CDI z ABS with ABS с ABS						
Mercedes Vito (BM638)	ZWP-6650	03.99>	0039P 0086T 0039T	WP-002 WP-390 WP-007 WP-007 WP-196 WP-115	PL PP CL CP TL TP	105 105 0850 105 105 2250 105 105 3900 105 105 3900 105 105 1300 105 105 1150
108 CDI, 110 CDI, 112 CDI bez ABS without ABS без ABS						
Mitsubishi Carisma	ZWP-6701	05.95>	0100P 0086T	WP-019 WP-039 WP-043 WP-043 WP-036 WP-253	PL PP TL TP CL CP	105 105 1000 105 105 1550 105 105 0200 105 105 0200 105 105 2100 105 105 4200
1600 (DA1A) 1800 (DA2A) 1900 (DA4A)						
Mitsubishi Colt	ZWP-6702	09.80>03.82	0017P 0017T	WP-070 WP-070 WP-145 WP-118 WP-136 WP-136 WP-146 WP-137	ZPL ZPP PL PP TL TP CC CC+	116 116 0200 116 116 0200 116 116 1850 116 116 0300 116 116 0850 116 116 0850 116 116 2100 116 116 2400
Wszystkie modele All models Все модели						

MARKA SAMOCHODU
CAR MODEL
МОДЕЛЬ АВТОМБИЯ

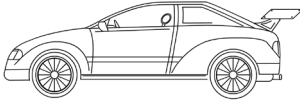

NUMER ZESTAWU
SET NUMBER
НОМЕР НАБОРА

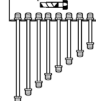

ROK PRODUKCJI
PRODUCTION YEAR
ГОД ВЫПУСКА АВТОМБИЯ



ODPOWIETRNIK
BLEEDER SCREW
ШТУЦЕР ПРОКАЧКИ ТОРМОЗОВ

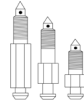

INDEKS
INDEX
ИНДЕКС



POŁOŻENIE
LOCATION
МЕСТО

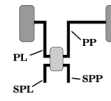

OPIS
DESCRIPTION
ОПИСАНИЕ

ZŁĄCZKA ZŁĄCZKA DŁUGOŚĆ
FITTING FITTING LENGTH
НАКОНЕЧНИК НАКОНЕЧНИК ДЛИНА

MARKA SAMOCHODU CAR MODEL МОДЕЛЬ АВТОМБИЯ	NUMER ZESTAWU SET NUMBER НОМЕР НАБОРА	ROK PRODUKCJI PRODUCTION YEAR ГОД ВЫПУСКА АВТОМБИЯ	ODPOWIETRNIK BLEEDER SCREW ШТУЦЕР ПРОКАЧКИ ТОРМОЗОВ	INDEKS INDEX ИНДЕКС	POŁOŻENIE LOCATION МЕСТО	OPIS DESCRIPTION ОПИСАНИЕ
Mitsubishi Colt						
Wszystkie modele All models Все модели	ZWP-6703	04.82>84	0017P	WP-070	ZPL	116 116 0200
				WP-070	ZPP	116 116 0200
				WP-147	PL	116 116 2000
				WP-118	PP	116 116 0300
				WP-136	TL	116 116 0850
				WP-136	TP	116 116 0850
				WP-137	CC	116 116 2400
				WP-127	CC+	116 116 2600
Mitsubishi Colt						
Wszystkie modele All models Все модели	ZWP-6704	85>03.88	0017P	WP-130	ZPL	116 116 0250
				WP-130	ZPP	116 116 0250
				WP-251	PL	116 116 1600
				WP-144	PP	116 116 0400
				WP-125	TL	116 116 0750
				WP-126	TP	116 116 0900
				WP-814	CL	116 116 2050
				WP-250	CP	116 116 1900
Mitsubishi Colt						
1300 (C51A, C51V), 1500 (C52A) *66	ZWP-6705	04.88>05.92	0086T	WP-118	ZPL	116 116 0300
				WP-118	ZPP	116 116 0300
				WP-581	PL	116 116 1400
				WP-144	PP	116 116 0400
				WP-070	TL	116 116 0200
				WP-070	TP	116 116 0200
				WP-129	SPL	116 116 1200
				WP-124	SPP	116 116 1350
				WP-816	STL	116 116 2250
				WP-823	STP	116 116 3250
Mitsubishi Colt						
1300 (CA1A) bez ABS without ABS без ABS *66	ZWP-6706	12.91>94	0086T	WP-810	PL	116 116 1250
				WP-141	PP	116 116 0600
				WP-070	TL	116 116 0200
				WP-070	TP	116 116 0200
				WP-430	CL	116 116 4200
				WP-139	CP	116 116 3100
Mitsubishi Colt						
1600 (CA4A) z ABS with ABS с ABS	ZWP-6707	12.91>94	0086T	WP-136	PL	116 116 0850
				WP-137	PP	116 116 2400
				WP-070	TL	116 116 0200
				WP-070	TP	116 116 0200
				WP-430	CL	116 116 4200
				WP-139	CP	116 116 3100
Mitsubishi Colt						
1800 (C58A) *66	ZWP-6708	11.89>05.96	0086T	WP-118	ZPL	116 116 0300
				WP-118	ZPP	116 116 0300
				WP-581	PL	116 116 1400
				WP-144	PP	116 116 0400
				WP-118	TL	116 116 0300
				WP-118	TP	116 116 0300
				WP-129	SPL	116 116 1200
				WP-124	SPP	116 116 1350
				WP-816	STL	116 116 2250
				WP-823	STP	116 116 3250
Mitsubishi Colt						
Wszystkie modele All models Все модели	ZWP-6744	06.04>		WP-018	PL	105 105 0650
				WP-003	PP	105 105 1400
				WP-004	CL	105 105 3100
				WP-712	CP	105 105 4050
Mitsubishi Galant						
1600 (E11A), 1800 (E14A)	ZWP-6709	85>87	0017P	WP-130	ZPL	116 116 0250
				WP-130	ZPP	116 116 0250
				WP-223	PL	116 116 1550
				WP-134	PP	116 116 0500
				WP-070	TL	116 116 0200
				WP-070	TP	116 116 0200
				WP-449	CC	116 116 3800
				WP-450	CC+	116 116 5700
Mitsubishi Galant						
1600 (E31A), 1800 (E32A, E34A) bez ABS without ABS без ABS	ZWP-6710	88>90	0017P	WP-130	ZPL	116 116 0250
				WP-118	ZPP	116 116 0300
				WP-125	PL	116 116 0750
				WP-124	PP	116 116 1350
				WP-070	TL	116 116 0200
				WP-070	TP	116 116 0200
				WP-139	CC	116 116 3100
				WP-569	CC+	116 116 4050

MARKA SAMOCHODU
CAR MODEL
МОДЕЛЬ АВТОМБИЯ

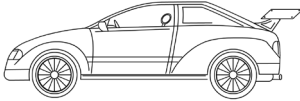

NUMER ZESTAWU
SET NUMBER
НОМЕР НАБОРА

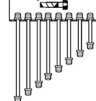

ROK PRODUKCJI
PRODUCTION YEAR
ГОД ВЫПУСКА АВТОМБИЯ



ODPOWIETRZNIK
BLEEDER SCREW
ШТУЦЕР ПРОКАЧКИ ТОРМОЗОВ

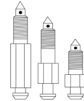

INDEKS
INDEX
ИНДЕКС



POŁOŻENIE
LOCATION
МЕСТО

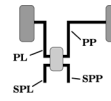

OPIS
DESCRIPTION
ОПИСАНИЕ

ZŁĄCZKA
FITTING
НАКОНЕЧНИК

ZŁĄCZKA
FITTING
НАКОНЕЧНИК

DŁUGOŚĆ
LENGTH
ДЛИНА

MARKA SAMOCHODU CAR MODEL МОДЕЛЬ АВТОМБИЯ	NUMER ZESTAWU SET NUMBER НОМЕР НАБОРА	ROK PRODUKCJI PRODUCTION YEAR ГОД ВЫПУСКА АВТОМБИЯ	ODPOWIETRZNIK BLEEDER SCREW ШТУЦЕР ПРОКАЧКИ ТОРМОЗОВ	INDEKS INDEX ИНДЕКС	POŁOŻENIE LOCATION МЕСТО	OPIS DESCRIPTION ОПИСАНИЕ	
Mitsubishi Galant							
1800 (E32A) z ABS with ABS с ABS	ZWP-6711	10.88>05.91	0017P	WP-118	ZPL	116 116 0300	
				WP-118	ZPP	116 116 0300	
				WP-125	PL	116 116 0750	
				WP-127	PP	116 116 2600	
				WP-120	TL	116 116 0550	
				WP-222	TP	116 116 1650	
				WP-130	ZTL	116 116 0250	
				WP-130	ZTP	116 116 0250	
				0069T	WP-137	CL	116 116 2400
				0086T	WP-818	CP	116 116 2550
Mitsubishi Galant							
2000 (E15A), 2400 (E16A) bez ABS without ABS без ABS	ZWP-6712	85>87	0017P	WP-130	ZPL	116 116 0250	
				WP-118	ZPP	116 116 0300	
				WP-223	PL	116 116 1550	
				WP-134	PP	116 116 0500	
				WP-130	TL	116 116 0250	
				WP-130	TP	116 116 0250	
				0086T	WP-449	CC	116 116 3800
					WP-450	CC+	116 116 5700
				Mitsubishi Galant			
2000 (E15A), 2400 (E16A) z ABS with ABS с ABS	ZWP-6713	85>87	0017P	WP-130	ZPL	116 116 0250	
				WP-118	ZPP	116 116 0300	
				WP-125	PL	116 116 0750	
				WP-142	PP	116 116 2500	
				WP-218	TL	116 116 1800	
				WP-141	TP	116 116 0600	
				WP-130	ZTL	116 116 0250	
				WP-130	ZTP	116 116 0250	
				0086T	WP-236	CC	116 116 3200
					WP-236	CC+	116 116 3200
Mitsubishi Galant							
2000 (E38A, E39A) bez ABS without ABS без ABS	ZWP-6714	89>90	0017P	WP-130	ZPL	116 116 0250	
				WP-118	ZPP	116 116 0300	
				WP-125	PL	116 116 0750	
				WP-124	PP	116 116 1350	
				0086T	WP-825	CC	116 116 3450
					WP-827	CC+	116 116 4300
Mitsubishi Galant							
2000 (E33A) bez ABS without ABS без ABS	ZWP-6715	88>90	0017P	WP-130	ZPL	116 116 0250	
				WP-118	ZPP	116 116 0300	
				WP-125	PL	116 116 0750	
				WP-124	PP	116 116 1350	
				WP-118	TL	116 116 0300	
				WP-130	TP	116 116 0250	
				0086T	WP-825	CC	116 116 3450
					WP-827	CC+	116 116 4300
Mitsubishi Galant							
2000 (E38A, E39A) z ABS with ABS с ABS	ZWP-6716	88>90	0017P	WP-130	ZPL	116 116 0250	
				WP-118	ZPP	116 116 0300	
				WP-126	PL	116 116 0900	
				WP-819	PP	116 116 2700	
				WP-810	SPL	116 116 1250	
				WP-124	SPP	116 116 1350	
				0086T	WP-825	STL	116 116 3450
					WP-827	STP	116 116 4300
Mitsubishi Galant							
2000 (E38A) z ABS with ABS с ABS	ZWP-6711	10.88>05.91	0017P	WP-118	ZPL	116 116 0300	
				WP-118	ZPP	116 116 0300	
				WP-125	PL	116 116 0750	
				WP-127	PP	116 116 2600	
				WP-120	TL	116 116 0550	
				WP-222	TP	116 116 1650	
				WP-130	ZTL	116 116 0250	
				WP-130	ZTP	116 116 0250	
				0086T	WP-137	CL	116 116 2400
					WP-818	CP	116 116 2550
Mitsubishi Galant							
1800 (E32A) z ABS with ABS с ABS	ZWP-6711	06.91>10.91	0017P	WP-118	ZPL	116 116 0300	
				WP-118	ZPP	116 116 0300	
				WP-125	PL	116 116 0750	
				WP-127	PP	116 116 2600	
				WP-120	TL	116 116 0550	
				WP-222	TP	116 116 1650	
				WP-130	ZTL	116 116 0250	
				WP-130	ZTP	116 116 0250	
				0069T	WP-137	CL	116 116 2400
				0086T	WP-818	CP	116 116 2550

MARKA SAMOCHODU
CAR MODEL
МОДЕЛЬ АВТОМБИЯ

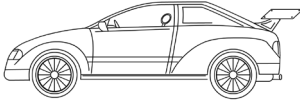

NUMER ZESTAWU
SET NUMBER
НОМЕР НАБОРА

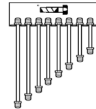

ROK PRODUKCJI
PRODUCTION YEAR
ГОД ВЫПУСКА АВТОМБИЯ



ODPOWIETRZNIK
BLEEDER SCREW
ШТУЦЕР ПРОКАЧКИ ТОРМОЗОВ

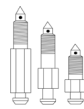

INDEKS
INDEX
ИНДЕКС



POŁOŻENIE
LOCATION
МЕСТО

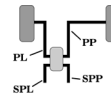

OPIS
DESCRIPTION
ОПИСАНИЕ

ZŁĄCZKA
FITTING
НАКОНЕЧНИК

ZŁĄCZKA
FITTING
НАКОНЕЧНИК

DŁUGOŚĆ
LENGTH
ДЛИНА

MARKA SAMOCHODU CAR MODEL МОДЕЛЬ АВТОМБИЯ	NUMER ZESTAWU SET NUMBER НОМЕР НАБОРА	ROK PRODUKCJI PRODUCTION YEAR ГОД ВЫПУСКА АВТОМБИЯ	ODPOWIETRZNIK BLEEDER SCREW ШТУЦЕР ПРОКАЧКИ ТОРМОЗОВ	INDEKS INDEX ИНДЕКС	POŁOŻENIE LOCATION МЕСТО	OPIS DESCRIPTION ОПИСАНИЕ	
Mitsubishi Galant							
1800 (E32A) z ABS with ABS c ABS	ZWP-6719	11.91>10.92	0088P	WP-118	ZPL	116 116 0300	
				WP-118	ZPP	116 116 0300	
				WP-125	PL	116 116 0750	
				WP-818	PP	116 116 2550	
				WP-120	TL	116 116 0550	
				WP-222	TP	116 116 1650	
				WP-130	ZTL	116 116 0250	
				WP-130	ZTP	116 116 0250	
				0069T	CL	116 116 2400	
				0086T	WP-818	CP	116 116 2550
Mitsubishi Galant							
1800 (E52A) z ABS with ABS c ABS	ZWP-6720	11.92>11.94	0088P	WP-581	PL	116 116 1400	
				WP-131	PP	116 116 0700	
				WP-070	TL	116 116 0200	
				WP-070	TP	116 116 0200	
				0086T	WP-827	CL	116 116 4300
				0069T	WP-122	CP	116 116 3700
*66							
Mitsubishi Galant							
1800 (E52A) z ABS with ABS c ABS	ZWP-6721	11.92>11.94	0088P	WP-581	PL	116 116 1400	
				WP-131	PP	116 116 0700	
				0086T	WP-827	CL	116 116 4300
				0069T	WP-122	CP	116 116 3700
Mitsubishi Galant							
2000 (E33A) z ABS with ABS c ABS	ZWP-6711	06.91>10.92	0088P	WP-118	ZPL	116 116 0300	
				WP-118	ZPP	116 116 0300	
				WP-125	PL	116 116 0750	
				WP-127	PP	116 116 2600	
				WP-120	TL	116 116 0550	
				WP-222	TP	116 116 1650	
				WP-130	ZTL	116 116 0250	
				WP-130	ZTP	116 116 0250	
				0086T	WP-137	CL	116 116 2400
				0086T	WP-818	CP	116 116 2550
Mitsubishi Galant							
2000 (E54A, E55A, E57A) z ABS with ABS c ABS	ZWP-6720	11.92>11.94	0088P	WP-581	PL	116 116 1400	
				WP-131	PP	116 116 0700	
				WP-070	TL	116 116 0200	
				WP-070	TP	116 116 0200	
				0086T	WP-827	CL	116 116 4300
				0086T	WP-122	CP	116 116 3700
*66							
Mitsubishi Galant							
2000 (E54A, E55A, E57A) z ABS with ABS c ABS	ZWP-6721	11.92>11.94	0088P	WP-581	PL	116 116 1400	
				WP-131	PP	116 116 0700	
				0086T	WP-827	CL	116 116 4300
				0086T	WP-122	CP	116 116 3700
Mitsubishi Galant							
1800 (E52A) z ABS z ABS with ABS c ABS	ZWP-6725	12.94>05.96	0088P	WP-224	PL	116 116 1450	
				WP-138	PP	116 116 0350	
				0086T	WP-070	TL	116 116 0200
				0069T	WP-070	TP	116 116 0200
				0086T	WP-827	CL	116 116 4300
				0069T	WP-567	CP	116 116 3550
*66							
Mitsubishi Galant							
1800 (E52A) z ABS with ABS c ABS	ZWP-6726	12.94>05.96	0088P	WP-224	PL	116 116 1450	
				0086T	WP-138	PP	116 116 0350
				0086T	WP-827	CL	116 116 4300
				0069T	WP-567	CP	116 116 3550
*67							
Mitsubishi Galant							
2000 (E54A, E55A, E57A) z ABS with ABS c ABS	ZWP-6725	12.94>05.96	0088P	WP-224	PL	116 116 1450	
				WP-138	PP	116 116 0350	
				0086T	WP-070	TL	116 116 0200
				0086T	WP-070	TP	116 116 0200
				0086T	WP-827	CL	116 116 4300
				0086T	WP-567	CP	116 116 3550
*66							
Mitsubishi Galant							
2000 (E54A, E55A, E57A) z ABS with ABS c ABS	ZWP-6726	12.94>05.96	0088P	WP-224	PL	116 116 1450	
				0086T	WP-138	PP	116 116 0350
				0086T	WP-827	CL	116 116 4300
				0086T	WP-567	CP	116 116 3550
*67							
Mitsubishi Galant							
2000 (EA2A, EA6A) z ABS with ABS c ABS	ZWP-6729	10.96>03.00	0088P	WP-810	PL	116 116 1250	
				0086T	WP-134	PP	116 116 0500
				0086T	WP-827	CL	116 116 4300
				0086T	WP-824	CP	116 116 3350
*67							
Mitsubishi Galant							
2500 (EA5A) z ABS with ABS c ABS	ZWP-6729	10.96>03.00	0088P	WP-810	PL	116 116 1250	
				0086T	WP-134	PP	116 116 0500
				0086T	WP-827	CL	116 116 4300
				0086T	WP-824	CP	116 116 3350
*67							

MARKA SAMOCHODU
CAR MODEL
МОДЕЛЬ АВТОМБИЯ

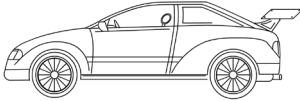

NUMER ZESTAWU
SET NUMBER
НОМЕР НАБОРА

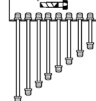

ROK PRODUKCJI
PRODUCTION YEAR
ГОД ВЫПУСКА АВТОМБИЯ



ODPOWIETRZNIK
BLEEDER SCREW
ШТУЦЕР ПРОКАЧКИ ТОРМОЗОВ

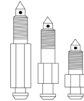

INDEKS
INDEX
ИНДЕКС



POŁOŻENIE
LOCATION
МЕСТО

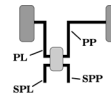

OPIS
DESCRIPTION
ОПИСАНИЕ

ZŁĄCZKA ZŁĄCZKA DŁUGOŚĆ
FITTING FITTING LENGTH
НАКОНЕЧНИК НАКОНЕЧНИК ДЛИНА

MARKA SAMOCHODU CAR MODEL МОДЕЛЬ АВТОМБИЯ	NUMER ZESTAWU SET NUMBER НОМЕР НАБОРА	ROK PRODUKCJI PRODUCTION YEAR ГОД ВЫПУСКА АВТОМБИЯ	ODPOWIETRZNIK BLEEDER SCREW ШТУЦЕР ПРОКАЧКИ ТОРМОЗОВ	INDEKS INDEX ИНДЕКС	POŁOŻENIE LOCATION МЕСТО	OPIS DESCRIPTION ОПИСАНИЕ
Mitsubishi Lancer						
Wszystkie modele All models Все модели	ZWP-6703	04.82>84	0017P	WP-070	ZPL	116 116 0200
				WP-070	ZPP	116 116 0200
				WP-147	PL	116 116 2000
				WP-118	PP	116 116 0300
				WP-136	TL	116 116 0850
				WP-136	TP	116 116 0850
				WP-137	CC	116 116 2400
				WP-127	CC+	116 116 2600
			0017T			
Mitsubishi Lancer						
Wszystkie modele All models Все модели	ZWP-6704	85>88	0017P	WP-130	ZPL	116 116 0250
				WP-130	ZPP	116 116 0250
				WP-251	PL	116 116 1600
				WP-144	PP	116 116 0400
				WP-125	TL	116 116 0750
				WP-126	TP	116 116 0900
				WP-814	CL	116 116 2050
				WP-250	CP	116 116 1900
			0017T			
Mitsubishi Lancer						
1300 (CB1A) bez ABS without ABS без ABS	ZWP-6706	12.91>	0088P	WP-810	PL	116 116 1250
				WP-141	PP	116 116 0600
				WP-070	TL	116 116 0200
				WP-070	TP	116 116 0200
				WP-430	CL	116 116 4200
*66			0086T	WP-139	CP	116 116 3100
Mitsubishi Lancer						
1300 (C61A), 1500 (C62A)	ZWP-6734	04.88>05.94	0088P	WP-118	ZPL	116 116 0300
				WP-118	ZPP	116 116 0300
				WP-581	PL	116 116 1400
				WP-144	PP	116 116 0400
				WP-070	TL	116 116 0200
				WP-070	TP	116 116 0200
				WP-129	SPL	116 116 1200
				WP-124	SPP	116 116 1350
				WP-816	STL	116 116 2250
				WP-143	STP	116 116 3300
			0086T			
Mitsubishi Lancer						
1600 (CB4A) z ABS with ABS с ABS	ZWP-6707	12.91>94	0088P	WP-136	PL	116 116 0850
				WP-137	PP	116 116 2400
				WP-070	TL	116 116 0200
				WP-070	TP	116 116 0200
				WP-430	CL	116 116 4200
			0086T	WP-139	CP	116 116 3100
Mitsubishi L300						
K11T, K12T, K14T	ZWP-6736	11.86>08.96	0017P	WP-070	ZPL	116 116 0200
				WP-070	ZPP	116 116 0200
				WP-118	PL	116 116 0300
				WP-144	PL+	116 116 0400
				WP-813	PP	116 116 1950
				WP-134	TL	116 116 0500
				WP-251	TP	116 116 1600
				WP-824	CC	116 116 3350
				WP-825	CC+	116 116 3450
Mitsubishi L300						
P03V	ZWP-6737	11.86>05.94	0017P	WP-118	ZPL	116 116 0300
				WP-118	ZPP	116 116 0300
				WP-118	PL	116 116 0300
				WP-148	PP	116 116 0800
				WP-431	TL	116 116 0650
				WP-222	TP	116 116 1650
				WP-147	SPL	116 116 2000
				WP-133	SPP	116 116 1100
				WP-250	STL	116 116 1900
				WP-250	STP	116 116 1900
			0017T			
Mitsubishi L300						
P04V	ZWP-6737	11.86>05.94	0017P	WP-118	ZPL	116 116 0300
				WP-118	ZPP	116 116 0300
				WP-118	PL	116 116 0300
				WP-148	PP	116 116 0800
				WP-431	TL	116 116 0650
				WP-222	TP	116 116 1650
				WP-147	SPL	116 116 2000
				WP-133	SPP	116 116 1100
				WP-250	STL	116 116 1900
				WP-250	STP	116 116 1900
			0017T			

MARKA SAMOCHODU
CAR MODEL
МОДЕЛЬ АВТОМБИЯ

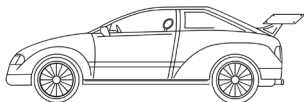

NUMER ZESTAWU
SET NUMBER
НОМЕР НАБОРА

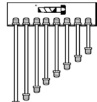

ROK PRODUKCJI
PRODUCTION YEAR
ГОД ВЫПУСКА АВТОМБИЯ



ODPOWIETRZNIK
BLEEDER SCREW
ШТУЦЕР ПРОКАЧКИ ТОРМОЗОВ

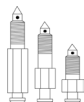

INDEKS
INDEX
ИНДЕКС



POŁOŻENIE
LOCATION
МЕСТО

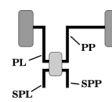

OPIS
DESCRIPTION
ОПИСАНИЕ

ZŁĄCZKA
FITTING
НАКОНЕЧНИК

ZŁĄCZKA
FITTING
НАКОНЕЧНИК

DŁUGOŚĆ
LENGTH
ДЛИНА

MARKA SAMOCHODU CAR MODEL МОДЕЛЬ АВТОМБИЯ	NUMER ZESTAWU SET NUMBER НОМЕР НАБОРА	ROK PRODUKCJI PRODUCTION YEAR ГОД ВЫПУСКА АВТОМБИЯ	ODPOWIETRZNIK BLEEDER SCREW ШТУЦЕР ПРОКАЧКИ ТОРМОЗОВ	INDEKS INDEX ИНДЕКС	POŁOŻENIE LOCATION МЕСТО	OPIS DESCRIPTION ОПИСАНИЕ
Mitsubishi L300						
P05V	ZWP-6737	11.86>05.94	0017P	WP-118	ZPL	116 116 0300
				WP-118	ZPP	116 116 0300
				WP-118	PL	116 116 0300
				WP-148	PP	116 116 0800
				WP-431	TL	116 116 0650
				WP-222	TP	116 116 1650
				WP-147	SPL	116 116 2000
				WP-133	SPP	116 116 1100
				WP-250	STL	116 116 1900
				WP-250	STP	116 116 1900
Mitsubishi L300						
P25V	ZWP-6740	11.86>05.94	0017P	WP-070	ZPL	116 116 0200
				WP-070	ZPP	116 116 0200
				WP-431	PL	116 116 0650
				WP-581	PP	116 116 1400
				WP-431	TL	116 116 0650
				WP-220	TP	116 116 1700
				WP-147	SPL	116 116 2000
				WP-124	SPP	116 116 1350
				WP-250	STL	116 116 1900
				WP-250	STP	116 116 1900
Mitsubishi L300						
P45V	ZWP-6741	11.86>05.94	0017P	WP-070	ZPL	116 116 0200
				WP-070	ZPP	116 116 0200
				WP-431	PL	116 116 0650
				WP-581	PP	116 116 1400
				WP-431	TL	116 116 0650
				WP-220	TP	116 116 1700
				WP-124	SPL	116 116 1350
				WP-147	SPP	116 116 2000
				WP-250	STL	116 116 1900
				WP-147	STP	116 116 2000
Mitsubishi Pajero						
Wszystkie modele All models Все модели	ZWP-6742	04.83>87	0019P	WP-070	ZPL	116 116 0200
				WP-070	ZPP	116 116 0200
				WP-134	PL	116 116 0500
				WP-127	PP	116 116 2600
				WP-144	TL	116 116 0400
				WP-251	TP	116 116 1600
				WP-137	CC	116 116 2400
				WP-127	CC+	116 116 2600
				0017T		
Mitsubishi Space Star						
Wszystkie modele All models Все модели	ZWP-6743	06.98>	0100P	WP-014	PL	105 105 2400
				WP-033	PP	105 105 0700
				WP-032	CL	105 105 2800
				WP-007	CP	105 105 3900
0053T						
Moskwicz 2140						
	ZWP-6801	78>		WP-1121	PL	112 112 0520
				WP-991	PL+	112 112 0610
				WP-1313	PP	112 112 1225
				WP-1353	PP+	112 112 1440
				WP-53	TL	112 112 0500
				WP-410	TP	112 112 1000
				WP-55	CC	112 112 2100
				0053T		
Moskwicz M412						
	ZWP-6802	03.71>		WP-612	PL	103 103 0500
				WP-613	PL+	103 103 0700
				WP-617	PP	103 103 1200
				WP-645	PP+	103 103 1450
				WP-631	TL	103 103 0450
				WP-633	TP	103 103 0950
				WP-646	CC	103 103 2050
0053T						
Nissan Almera N15						
Wszystkie modele, z ABS All models, with ABS Все модели, с ABS	ZWP-6901	07.95>04.00		WP-140	PL	116 116 1500
				WP-123	PP	116 116 0450
				WP-963	TL	116 116 3300
				WP-568	TP	116 116 4150
Nissan 1500						
Pick-up	ZWP-6902	70>77	0017P	WP-140	PL	116 116 1500
				WP-148	PP	116 116 0800
				WP-129	TL	116 116 1200
				WP-118	TP	116 116 0300
				WP-133	CL	116 116 1100
				WP-250	SPP	116 116 1900
				WP-813	STP	116 116 1950
*68			0053T			

MARKA SAMOCHODU
CAR MODEL
МОДЕЛЬ АВТОМБИЯ

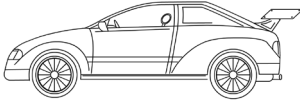

NUMER ZESTAWU
SET NUMBER
НОМЕР НАБОРА

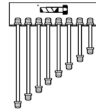

ROK PRODUKCJI
PRODUCTION YEAR
ГОД ВЫПУСКА АВТОМБИЯ



ODPOWIETRZNIK
BLEEDER SCREW
ШТУЦЕР ПРОКАЧКИ ТОРМОЗОВ

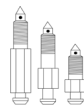

INDEKS
INDEX
ИНДЕКС



POŁOŻENIE
LOCATION
МЕСТО

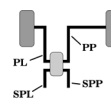

OPIS
DESCRIPTION
ОПИСАНИЕ

ZŁĄCZKA
FITTING
НАКОНЕЧНИК

ZŁĄCZKA
FITTING
НАКОНЕЧНИК

DŁUGOŚĆ
LENGTH
ДЛИНА

MARKA SAMOCHODU CAR MODEL МОДЕЛЬ АВТОМБИЯ	NUMER ZESTAWU SET NUMBER НОМЕР НАБОРА	ROK PRODUKCJI PRODUCTION YEAR ГОД ВЫПУСКА АВТОМБИЯ	ODPOWIETRZNIK BLEEDER SCREW ШТУЦЕР ПРОКАЧКИ ТОРМОЗОВ	INDEKS INDEX ИНДЕКС	POŁOŻENIE LOCATION МЕСТО	OPIS DESCRIPTION ОПИСАНИЕ	
Nissan 1500							
Pick-up *69 *74	ZWP-6903	77>80	0017P	WP-118	ZPL	116 116 0300	
				WP-118	ZPP	116 116 0300	
				WP-140	PL	116 116 1500	
				WP-123	PP	116 116 0450	
				WP-136	PP+	116 116 0850	
				WP-129	TL	116 116 1200	
				WP-118	TP	116 116 0300	
				WP-960	CL	116 116 0850	
				WP-145	SPP	116 116 1850	
				0053T	WP-147	STP	116 116 2000
Nissan 100A, 120A							
E10 Sedan	ZWP-6904	09.71>77	0017P	WP-135	ZPL	116 116 0150	
				WP-135	ZPP	116 116 0150	
				WP-136	PL	116 116 0850	
				WP-130	PP	116 116 0250	
				WP-119	TL	116 116 0950	
				WP-120	ZTL	116 116 0550	
				WP-120	ZTP	116 116 0550	
				0053T	WP-137	CC	116 116 2400
Nissan 100A, 120A							
F10 Sedan, Coupe	ZWP-6905	02.75>01.78	0017P	WP-130	ZPL	116 116 0250	
				WP-130	ZPP	116 116 0250	
				WP-140	PL	116 116 1500	
				WP-141	PP	116 116 0600	
				WP-119	TL	116 116 0950	
				WP-120	ZTL	116 116 0550	
				WP-120	ZTP	116 116 0550	
				0053T	WP-142	CC	116 116 2500
Nissan 100A, 120A							
F10 Sedan, Coupe	ZWP-6905	02.75>79	0017P	WP-130	ZPL	116 116 0250	
				WP-130	ZPP	116 116 0250	
				WP-140	PL	116 116 1500	
				WP-141	PP	116 116 0600	
				WP-119	TL	116 116 0950	
				WP-120	ZTL	116 116 0550	
				WP-120	ZTP	116 116 0550	
				0053T	WP-142	CC	116 116 2500
Nissan 100A, 120A							
E10 Kombi	ZWP-6907	09.71>77	0017P	WP-135	ZPL	116 116 0150	
				WP-135	ZPP	116 116 0150	
				WP-136	PL	116 116 0850	
				WP-130	PP	116 116 0250	
				WP-133	TL	116 116 1100	
				WP-118	TP	116 116 0300	
				0053T	WP-822	CC	116 116 3050
				Nissan 100A, 120A			
E10 Kombi	ZWP-6908	02.75>01.78	0017P	WP-130	ZPL	116 116 0250	
				WP-130	ZPP	116 116 0250	
				WP-140	PL	116 116 1500	
				WP-141	PP	116 116 0600	
				WP-133	TL	116 116 1100	
				WP-118	TP	116 116 0300	
				0053T	WP-143	CC	116 116 3300
				Nissan 100A, 120A			
E10 Kombi	ZWP-6908	02.75>79	0017P	WP-130	ZPL	116 116 0250	
				WP-130	ZPP	116 116 0250	
				WP-140	PL	116 116 1500	
				WP-141	PP	116 116 0600	
				WP-133	TL	116 116 1100	
				WP-118	TP	116 116 0300	
				0053T	WP-143	CC	116 116 3300
				Nissan 120Y, 140Y			
B210	ZWP-6910	09.74>78	0017P	WP-118	ZPL	116 116 0300	
				WP-118	ZPP	116 116 0300	
				WP-129	PL	116 116 1200	
				WP-131	PP	116 116 0700	
				WP-133	TL	116 116 1100	
				WP-134	TP	116 116 0500	
				0053T	WP-142	CC	116 116 2500
				Nissan 120Y, 140Y			
B310	ZWP-6911	78>82	0017P	WP-118	ZPL	116 116 0300	
				WP-118	ZPP	116 116 0300	
				WP-124	PL	116 116 1350	
				WP-134	PP	116 116 0500	
				WP-132	TL	116 116 1050	
				WP-141	TP	116 116 0600	
				0053T	WP-137	CC	116 116 2400

MARKA SAMOCHODU
CAR MODEL
МОДЕЛЬ АВТОМБИЯ

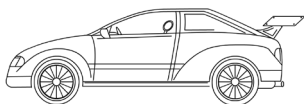

NUMER ZESTAWU
SET NUMBER
НОМЕР НАБОРА

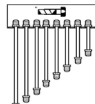

ROK PRODUKCJI
PRODUCTION YEAR
ГОД ВЫПУСКА АВТОМБИЯ



ODPOWIETRNIK
BLEEDER SCREW
ШТУЦЕР ПРОКАЧКИ ТОРМОЗОВ



INDEKS
INDEX
ИНДЕКС



POŁOŻENIE
LOCATION
МЕСТО

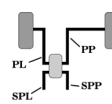

OPIS
DESCRIPTION
ОПИСАНИЕ

ZŁĄCZKA
FITTING
НАКОНЕЧНИК

ZŁĄCZKA
FITTING
НАКОНЕЧНИК

DŁUGOŚĆ
LENGTH
ДЛИНА

MARKA SAMOCHODU CAR MODEL МОДЕЛЬ АВТОМБИЯ	NUMER ZESTAWU SET NUMBER НОМЕР НАБОРА	ROK PRODUKCJI PRODUCTION YEAR ГОД ВЫПУСКА АВТОМБИЯ	ODPOWIETRNIK BLEEDER SCREW ШТУЦЕР ПРОКАЧКИ ТОРМОЗОВ	INDEKS INDEX ИНДЕКС	POŁOŻENIE LOCATION МЕСТО	OPIS DESCRIPTION ОПИСАНИЕ				
Nissan 140J, 160J										
710 Std, DX	ZWP-6912	09.74>79	0017P	WP-118	ZPL	116 116 0300				
				WP-118	ZPP	116 116 0300				
				WP-144	PL	116 116 0400				
				WP-134	PP	116 116 0500				
				WP-119	TL	116 116 0950				
				WP-120	TP	116 116 0550				
				WP-125	SP	116 116 0750				
				WP-127	ST	116 116 2600				
			0053T							
Nissan 120Y, 140Y										
A10 Violet	ZWP-6913	08.78>82	0017P	WP-144	ZPL	116 116 0400				
				WP-144	ZPP	116 116 0400				
				WP-144	PL	116 116 0400				
				WP-251	PP	116 116 1600				
				WP-132	TL	116 116 1050				
				WP-141	TP	116 116 0600				
				WP-146	CC	116 116 2100				
			0053T							
Nissan 160B, 180B										
810	ZWP-6914	08.76>06.80	0017P	WP-144	ZPL	116 116 0400				
				WP-144	ZPP	116 116 0400				
				WP-134	PL	116 116 0500				
				WP-134	PP	116 116 0500				
				WP-134	TL	116 116 0500				
				WP-120	TP	116 116 0550				
				WP-815	CL	116 116 2150				
				WP-148	SPP	116 116 0800				
				WP-119	STP	116 116 0950				
			0053T							
Nissan Bluebird										
U11	ZWP-6953	01.84>11.85	0017P	WP-126	PL	116 116 0900				
				WP-133	PP	116 116 1100				
				WP-824	CL	116 116 3350				
				WP-824	CP	116 116 3550				
				WP-133	TP	116 116 1100				
				WP-136	TL	116 116 0850				
				WP-070	ZTL	116 116 0200				
				WP-070	ZTP	116 116 0200				
							0053T			
Nissan Bluebird										
910	ZWP-6915	01.80>84	0017P	WP-147	PL	116 116 2000				
				WP-141	PP	116 116 0600				
				WP-141	TL	116 116 0600				
				WP-120	TP	116 116 0550				
				WP-121	CC	116 116 2800				
			0053T							
Nissan Bluebird										
T12	ZWP-6916	12.85>06.87	0017P	WP-429	PL	116 116 1000				
				WP-813	PP	116 116 1950				
				WP-810	TL	116 116 1250				
				WP-126	TP	116 116 0900				
				WP-864	CL	116 116X 4000				
				WP-865	CP	116 116X 4200				
			0053T							
Nissan Bluebird										
T12	ZWP-6917	07.87>01.88	0017P	WP-429	PL	116 116 1000				
				WP-813	PP	116 116 1950				
				WP-810	TL	116 116 1250				
				WP-126	TP	116 116 0900				
				WP-862	CL	116 116X 3400				
				WP-868	CP	116 116X 4500				
			0053T							
Nissan Bluebird										
T12	ZWP-6918	02.88>02.90	0017P	WP-125	PL	116 116 0750				
				WP-813	PP	116 116 1950				
				WP-810	TL	116 116 1250				
				WP-126	TP	116 116 0900				
				WP-862	CL	116 116X 3400				
				WP-868	CP	116 116X 4500				
			0053T							
Nissan Bluebird										
U11 Kombi	ZWP-6919	84>06.90	0017P	WP-126	PL	116 116 0900				
				WP-133	PP	116 116 1100				
				WP-133	TL	116 116 1100				
				WP-136	TP	116 116 0850				
				WP-236	CC	116 116 3200				
				WP-236	CC+	116 116 3200				
			0053T							
Nissan Cherry										
N10	ZWP-6920	08.78>82	0017P	WP-130	ZPL	116 116 0250				
				WP-130	ZPP	116 116 0250				
				WP-132	PL	116 116 1050				
				WP-125	PP	116 116 0750				
				WP-132	TL	116 116 1050				
				WP-131	ZTL	116 116 0700				
				WP-131	ZTP	116 116 0700				
				WP-147	CL	116 116 2000				
				WP-235	CP	116 116 2200				
							0053T			

MARKA SAMOCHODU
CAR MODEL
МОДЕЛЬ АВТОМБИЯ

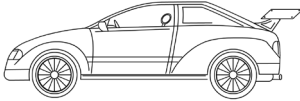

NUMER ZESTAWU
SET NUMBER
НОМЕР НАБОРА

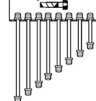

ROK PRODUKCJI
PRODUCTION YEAR
ГОД ВЫПУСКА АВТОМБИЯ



ODPOWIETRZNIK
BLEEDER SCREW
ШТУЦЕР ПРОКАЧКИ ТОРМОЗОВ

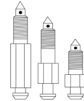

INDEKS
INDEX
ИНДЕКС



POŁOŻENIE
LOCATION
МЕСТО

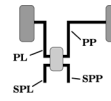

OPIS
DESCRIPTION
ОПИСАНИЕ

ZŁĄCZKA ZŁĄCZKA DŁUGOŚĆ
FITTING FITTING LENGTH
НАКОНЕЧНИК НАКОНЕЧНИК ДЛИНА

MARKA SAMOCHODU CAR MODEL МОДЕЛЬ АВТОМБИЯ	NUMER ZESTAWU SET NUMBER НОМЕР НАБОРА	ROK PRODUKCJI PRODUCTION YEAR ГОД ВЫПУСКА АВТОМБИЯ	ODPOWIETRZNIK BLEEDER SCREW ШТУЦЕР ПРОКАЧКИ ТОРМОЗОВ	INDEKS INDEX ИНДЕКС	POŁOŻENIE LOCATION МЕСТО	OPIS DESCRIPTION ОПИСАНИЕ		
Nissan Cherry								
N12	ZWP-6921	04.82>05.88	0017P	WP-133	PL	116 116 1100		
				WP-125	PP	116 116 0750		
				WP-126	TL	116 116 0900		
				WP-144	ZTL	116 116 0400		
				WP-144	ZTP	116 116 0400		
				WP-235	CL	116 116 2200		
				WP-235	CP	116 116 2200		
			0053T					
Nissan King Cab								
	ZWP-6922	82>85	0017P	WP-118	ZPL	116 116 0300		
				WP-118	ZPP	116 116 0300		
				WP-136	PL	116 116 0850		
				WP-235	PP	116 116 2200		
				WP-129	TL	116 116 1200		
				WP-123	TP	116 116 0450		
				WP-222	SP	116 116 1650		
			0053T					
				WP-218	ST	116 116 1800		
Nissan King Cab 2WD								
D21 (Z20, SD23, TD25)	ZWP-6923	09.85.04.92	0017P	WP-816	PL	116 116 2250		
				WP-859	PP	116 116X 2250		
				WP-855	TL	116 116X 1100		
				WP-850	TP	116 116X 0400		
				WP-581	SP	116 116 1400		
*73			0053T			WP-858	ST	116 116X 1850
Nissan King Cab 2WD								
D21 (Z20, SD23, TD25)	ZWP-6924	09.85.04.92	0017P	WP-816	PL	116 116 2250		
				WP-859	PP	116 116X 2250		
				WP-855	TL	116 116X 1100		
				WP-850	TP	116 116X 0400		
				WP-236	CL	116 116 3200		
				WP-823	CP	116 116 3250		
*74			0053T					
Nissan Micra								
K10	ZWP-6925	83>92	0017P	WP-144	PL	116 116 0400		
				WP-124	PP	116 116 1350		
				WP-135	TL	116 116 0150		
				WP-135	TP	116 116 0150		
				WP-127	CL	116 116 2600		
				WP-122	CP	116 116 3700		
			0053T					
Nissan Micra								
K11E bez ABS without ABS без ABS	ZWP-6926	08.92>02.03	0017P	WP-001	PL	105 105 0300		
				WP-196	PP	105 105 1300		
				WP-043	TL	105 105 0200		
				WP-043	TP	105 105 0200		
				WP-032	CC	105 105 2800		
				WP-032	CC+	105 105 2800		
			0039T					
Nissan Micra								
K11E z ABS with ABS с ABS	ZWP-6927	08.92>02.03	0017P	WP-024	PL	105 105 0800		
				WP-435	PP	105 105 1600		
				WP-024	TL	105 105 0800		
				WP-003	TP	105 105 1400		
				WP-032	CL	105 105 2800		
				WP-032	CP	105 105 2800		
			0039T					
Nissan Patrol								
160	ZWP-6928	11.79>90	0019P	WP-118	PL	116 116 0300		
				WP-148	PL+	116 116 0800		
				WP-126	PP	116 116 0900		
				WP-129	TL	116 116 1200		
				WP-134	TP	116 116 0500		
				WP-145	CL	116 116 1850		
				WP-145	SPP	116 116 1850		
				WP-429	STP	116 116 1000		
Nissan Patrol								
160/260	ZWP-6929	85>	0019P	WP-118	ZPL	116 116 0300		
				WP-118	ZPP	116 116 0300		
				WP-855	PL	116 116X 1100		
				WP-813	PP	116 116 1950		
				WP-856	TL	116 116X 1300		
				WP-852	TP	116 116X 0500		
				WP-220	SP	116 116 1700		
				WP-125	ST	116 116 0750		
Nissan Patrol								
260	ZWP-6930	04.89>	0019P	WP-354	PL	105 116 0350		
				WP-126	PP	116 116 0900		
				WP-119	TL	116 116 0950		
				WP-125	TP	116 116 0750		
				WP-820	CL	116 116 2950		
				WP-820	CP	116 116 2950		

MARKA SAMOCHODU
CAR MODEL
МОДЕЛЬ АВТОМБИЯ

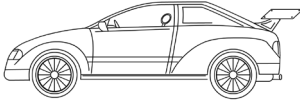

NUMER ZESTAWU
SET NUMBER
НОМЕР НАБОРА

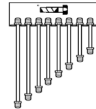

ROK PRODUKCJI
PRODUCTION YEAR
ГОД ВЫПУСКА АВТОМБИЯ



ODPOWIETRZNIK
BLEEDER SCREW
ШТУЦЕР ПРОКАЧКИ ТОРМОЗОВ

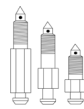

INDEKS
INDEX
ИНДЕКС



POŁOŻENIE
LOCATION
МЕСТО

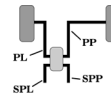

OPIS
DESCRIPTION
ОПИСАНИЕ

ZŁĄCZKA
FITTING
НАКОНЕЧНИК

ZŁĄCZKA
FITTING
НАКОНЕЧНИК

DŁUGOŚĆ
LENGTH
ДЛИНА

MARKA SAMOCHODU CAR MODEL МОДЕЛЬ АВТОМБИЯ	NUMER ZESTAWU SET NUMBER НОМЕР НАБОРА	ROK PRODUKCJI PRODUCTION YEAR ГОД ВЫПУСКА АВТОМБИЯ	ODPOWIETRZNIK BLEEDER SCREW ШТУЦЕР ПРОКАЧКИ ТОРМОЗОВ	INDEKS INDEX ИНДЕКС	POŁOŻENIE LOCATION МЕСТО	OPIS DESCRIPTION ОПИСАНИЕ
Nissan Pick-up						
720	ZWP-6922	80>08.85	0017P	WP-118	ZPL	116 116 0300
				WP-118	ZPP	116 116 0300
				WP-136	PL	116 116 0850
				WP-235	PP	116 116 2200
				WP-129	TL	116 116 1200
				WP-123	TP	116 116 0450
				WP-222	SP	116 116 1650
				WP-218	ST	116 116 1800
Nissan Primastar						
Wszystkie modele All models Все модели	ZWP-6954	03.01>	0039P	WP-484	PL	104 105 2000
				WP-014	PP	105 105 2400
				WP-036	CL	104 105 2100
				WP-016	CP	105 105 2900
				WP-028	TL	105 105 0550
				WP-028	TP	105 105 0550
Nissan Primera P10E						
Hatchback, Sedan 1.6	ZWP-6932	06.90>04.93	0019P	WP-009	PL	105 105 0600
				WP-036	PP	105 105 2100
				WP-001	TP	105 105 0300
				WP-571	CL	105 105 3850
				WP-044	CP	105 105 4800
			0069T			
Nissan Primera P10E						
Hatchback, Sedan 2.0 DE 2WD bez ABS without ABS без ABS	ZWP-6933	06.90>04.93	0039P	WP-196	PL	105 105 1300
				WP-009	PP	105 105 0600
				WP-024	TL	105 105 0800
				WP-019	TP	105 105 1000
				WP-021	CL	105 105 3600
WP-712	CP	105 105 4050				
Nissan Primera P10E						
Hatchback, Sedan 2.0 DI 2WD bez ABS without ABS без ABS	ZWP-6933	06.90>04.93	0039P	WP-196	PL	105 105 1300
				WP-009	PP	105 105 0600
				WP-024	TL	105 105 0800
				WP-019	TP	105 105 1000
				WP-021	CL	105 105 3600
WP-712	CP	105 105 4050				
Nissan Primera P10E						
Hatchback, Sedan 2.0 DE, 2.0DI z ABS with ABS с ABS	ZWP-6933	06.90>05.96	0039P	WP-196	PL	105 105 1300
				WP-009	PP	105 105 0600
				WP-024	TL	105 105 0800
				WP-019	TP	105 105 1000
				WP-021	CC	105 105 3600
WP-712	CC+	105 105 4050				
Nissan Primera P10E						
Hatchback, Sedan 2.0 Diesel 2WD bez ABS without ABS без ABS	ZWP-6936	06.90>04.93	0039P	WP-428	PL	105 105 2050
				WP-009	PP	105 105 0600
				WP-001	ZTL	105 105 0300
				WP-571	ZTP	105 105 0300
				WP-571	CL	105 105 3850
WP-044	CP	105 105 4800				
Nissan Primera P10E						
Hatchback, Sedan 1.6 DE 2WD bez ABS without ABS без ABS	ZWP-6955	05.93>06.96		WP-028	PL	105 105 0550
				WP-031	PP	105 105 2200
				WP-030	CL	105 105 3700
				WP-044	CP	105 105 4800
				WP-043	TL	105 105 0200
WP-043	TP	105 105 0200				
Nissan Primera P11E						
Wszystkie modele All models Все модели *66	ZWP-6937	06.96>07.02		WP-559	PL	105 105 2350
				WP-018	PP	105 105 0650
				WP-1689	CL	105 116X 4500
				WP-1688	CP	105 116X 3300
Nissan Primera P11E						
Wszystkie modele All models Все модели *67	ZWP-6938	06.96>07.02		WP-463	PL	105 116 1350
				WP-740	PP	105 116 1000
				WP-824	CL	116 116 3350
				WP-570	CP	116 116 4500
Nissan Primera W10						
Kombi 1.6, 2.0 Diesel bez ABS without ABS без ABS	ZWP-6939	07.90>04.93	0019P	WP-125	PL	116 116 0750
				WP-429	PP	116 116 1000
				WP-141	TL	116 116 0600
				WP-129	TP	116 116 1200
				WP-568	CC	116 116 4150
			0053T	WP-430	CC+	116 116 4200
Nissan Primera W10						
Kombi 2.0 bez diesel, bez ABS without diesel, without ABS без diesel, без ABS	ZWP-6940	07.90>04.93	0019P	WP-125	PL	116 116 0750
				WP-429	PP	116 116 1000
				WP-134	TL	116 116 0500
				WP-133	TP	116 116 1100
				WP-568	CC	116 116 4150
			0053T	WP-430	CC+	116 116 4200

MARKA SAMOCHODU
CAR MODEL
МОДЕЛЬ АВТОМБИЯ

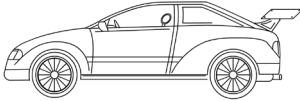

NUMER ZESTAWU
SET NUMBER
НОМЕР НАБОРА

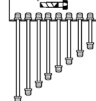

ROK PRODUKCJI
PRODUCTION YEAR
ГОД ВЫПУСКА АВТОМБИЯ



ODPOWIETRZNIK
BLEEDER SCREW
ШТУЦЕР ПРОКАЧКИ ТОРМОЗОВ

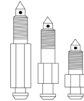

INDEKS
INDEX
ИНДЕКС



POŁOŻENIE
LOCATION
МЕСТО

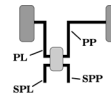

OPIS
DESCRIPTION
ОПИСАНИЕ

ZŁĄCZKA
FITTING
НАКОНЕЧНИК

ZŁĄCZKA
FITTING
НАКОНЕЧНИК

DŁUGOŚĆ
LENGTH
ДЛИНА

MARKA SAMOCHODU CAR MODEL МОДЕЛЬ АВТОМБИЯ	NUMER ZESTAWU SET NUMBER НОМЕР НАБОРА	ROK PRODUKCJI PRODUCTION YEAR ГОД ВЫПУСКА АВТОМБИЯ	ODPOWIETRZNIK BLEEDER SCREW ШТУЦЕР ПРОКАЧКИ ТОРМОЗОВ	INDEKS INDEX ИНДЕКС	POŁOŻENIE LOCATION МЕСТО	OPIS DESCRIPTION ОПИСАНИЕ
Nissan Primera W10						
Kombi 2.0 bez diesel, z ABS without diesel, with ABS без diesel, с ABS	ZWP-6941	07.90>98	0019P	WP-126	PL	116 116 0900
				WP-431	PP	116 116 0650
				WP-134	TL	116 116 0500
				WP-133	TP	116 116 1100
				WP-126	SP	116 116 0900
				WP-251	SP+	116 116 1600
				WP-569	ST	116 116 4050
				WP-568	ST+	116 116 4150
Nissan Primera WP11E						
Wszystkie modele All models Все модели *67	ZWP-6937	01.98>12.01		WP-559	PL	105 105 2350
				WP-018	PP	105 105 0650
				WP-1689	CL	105 116X 4500
				WP-1688	CP	105 116X 3300
Nissan Serena						
Wszystkie modele, bez ABS All models, without ABS Все модели, без ABS	ZWP-6943	10.95>	0017P	WP-353	PL	105 116 0950
				WP-118	PP	116 116 0300
				WP-132	TL	116 116 1050
				WP-431	TP	116 116 0650
				WP-131	TP+	116 116 0700
				WP-143	CL	116 116 3300
Nissan Serena						
Wszystkie modele, z I.R.S, bez ABS All models, with I.R.S, without ABS Все модели, с I.R.S, без ABS	ZWP-6944	10.95>03.98	0017P	WP-353	PL	105 116 0950
				WP-118	PP	116 116 0300
				WP-810	TL	116 116 1250
				WP-138	TP	116 116 0350
				WP-136	TP+	116 116 0850
				WP-130	ZTL	116 116 0250
				WP-130	ZTP	116 116 0250
				WP-225	CL	116 116 3900
Nissan Serena						
Wszystkie modele, z ABS All models, with ABS Все модели, с ABS	ZWP-6945	07.92>03.98	0017P	WP-235	PL	116 116 2200
				WP-220	PP	116 116 1700
				WP-809	TL	116 116 1150
				WP-138	TP	116 116 0350
				WP-136	TP+	116 116 0850
				WP-130	ZTL	116 116 0250
				WP-130	ZTP	116 116 0250
				WP-121	CL	116 116 2800
Nissan Stanza						
	ZWP-6946	82>86	0017P	WP-134	PL	116 116 0500
				WP-812	PP	116 116 1750
				WP-129	TP	116 116 1200
				WP-130	ZTL	116 116 0250
				WP-130	ZTP	116 116 0250
				WP-122	CL	116 116 3700
				WP-122	CP	116 116 3700
Nissan Sunny						
B11 bez Van bez Van without Van без Van	ZWP-6921	08.82>05.88	0017P	WP-133	PL	116 116 1100
				WP-125	PP	116 116 0750
				WP-126	TL	116 116 0900
				WP-144	ZTL	116 116 0400
				WP-144	ZTP	116 116 0400
				WP-235	CL	116 116 2200
Nissan Sunny						
B12, N13 bez diesel without diesel без diesel	ZWP-6948	06.86>10.90	0017P	WP-123	PL	116 116 0450
				WP-146	PP	116 116 2100
				WP-429	TP	116 116 1000
				WP-849	ZTL	116 116X 0200
				WP-849	ZTP	116 116X 0200
				WP-122	CL	116 116 3700
Nissan Sunny						
N14 1.4, 1.6, 2.0 Diesel bez ABS without ABS без ABS	ZWP-6949	10.90>	0019P	WP-118	PL	116 116 0300
				WP-218	PP	116 116 1800
				WP-406	TL	116 116X 0300
				WP-406	TP	116 116X 0300
				WP-122	CL	116 116 3700
Nissan Sunny						
N14 2.0 bez diesel, bez ABS without diesel, without ABS без diesel, без ABS	ZWP-6950	10.90>	0019P	WP-129	PL	116 116 1200
				WP-126	PP	116 116 0900
				WP-406	TL	116 116X 0300
				WP-406	TP	116 116X 0300
				WP-122	CL	116 116 3700
Nissan Sunny						
	ZWP-6950	10.90>	0053T	WP-570	CP	116 116 4500
				WP-570	CP	116 116 4500

MARKA SAMOCHODU
CAR MODEL
МОДЕЛЬ АВТОМБИЯ

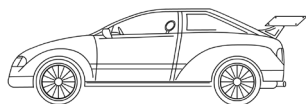

NUMER ZESTAWU
SET NUMBER
НОМЕР НАБОРА

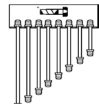

ROK PRODUKCJI
PRODUCTION YEAR
ГОД ВЫПУСКА АВТОМБИЯ



ODPOWIETRNIK
BLEEDER SCREW
ШТУЦЕР ПРОКАЧКИ ТОРМОЗОВ



INDEKS
INDEX
ИНДЕКС



POŁOŻENIE
LOCATION
МЕСТО

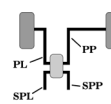

OPIS
DESCRIPTION
ОПИСАНИЕ

ZŁĄCZKA ZŁĄCZKA DŁUGOŚĆ
FITTING FITTING LENGTH
НАКОНЕЧНИК НАКОНЕЧНИК ДЛИНА

MARKA SAMOCHODU CAR MODEL МОДЕЛЬ АВТОМБИЯ	NUMER ZESTAWU SET NUMBER НОМЕР НАБОРА	ROK PRODUKCJI PRODUCTION YEAR ГОД ВЫПУСКА АВТОМБИЯ	ODPOWIETRNIK BLEEDER SCREW ШТУЦЕР ПРОКАЧКИ ТОРМОЗОВ	INDEKS INDEX ИНДЕКС	POŁOŻENIE LOCATION МЕСТО	OPIS DESCRIPTION ОПИСАНИЕ				
Nissan Sunny										
N14 1.4, 1.6 z ABS with ABS с ABS	ZWP-6951	10.92>	0019P	WP-132	PL	116 116 1050				
				WP-126	PP	116 116 0900				
				WP-122	CL	116 116 3700				
				0053T	WP-570	CP	116 116 4500			
Nissan Sunny										
Y10 2WD	ZWP-6952	11.90>	0019P	WP-129	PL	116 116 1200				
				WP-136	PP	116 116 0850				
				WP-120	TL	116 116 0550				
				WP-129	TP	116 116 1200				
				WP-820	SP	116 116 2950				
				WP-826	SP+	116 116 3950				
				WP-133	ST	116 116 1100				
				0053T	WP-133	ST+	116 116 1100			
Opel Ascona B										
1.2, 1.6	ZWP-7001	75>81	0088P 0090P	WP-043	ZPL	105 105 0200				
				WP-043	ZPP	105 105 0200				
				WP-045	PL	105 105 0400				
				WP-003	PP	105 105 1400				
				WP-018	TL	105 105 0650				
				WP-013	TP	105 105 0900				
				WP-004	SP	105 105 3100				
				0015T	WP-017	ST	105 105 0500			
Opel Ascona B										
1.6 Aut., 1.6S, 1.9, 2.0	ZWP-7002	75>81	0088P 0090P	WP-043	ZPL	105 105 0200				
				WP-043	ZPP	105 105 0200				
				WP-045	PL	105 105 0400				
				WP-196	PP	105 105 1300				
				WP-019	TL	105 105 1000				
				WP-009	TP	105 105 0600				
				WP-029	SP	105 105 3200				
				0015T	WP-045	ST	105 105 0400			
Opel Ascona C										
Wszystkie modele All models Все модели Nr G1000071, G6000000	ZWP-7003	81>85	0090P	WP-252	PL	105 105 1050				
				WP-047	PP	105 105 1500				
				WP-018	TL	105 105 0650				
				WP-018	TP	105 105 0650				
				WP-040	CL	105 105 3300				
				0015T	WP-025	CP	105 105 4300			
Opel Ascona C										
Wszystkie modele All models Все модели Nr G1000072, G6000001	ZWP-7004	86>88	0090P	WP-496	PL	104 105 1050				
				WP-047	PP	105 105 1500				
				WP-018	TL	105 105 0650				
				WP-018	TP	105 105 0650				
				WP-040	CL	105 105 3300				
				0015T	WP-025	CP	104 105 4300			
Opel Astra F										
Wszystkie modele, bez ABS, bez kombi All models, without ABS, without combi Все модели, без ABS, без combi	ZWP-7049	92>97	0100P 0011P	WP-441	PL	104 105 0500				
				WP-049	PP	105 105 1900				
				WP-1890	TL	104 106 0850				
				WP-090	TP	105 106 0650				
				WP-018	ZTL	105 105 0650				
				WP-018	ZTP	105 105 0650				
				0011T	WP-046	CL	105 105 3500			
				*74	0087T	WP-1724	CP	104 104 3600		
				Opel Astra F						
				Wszystkie modele, bez ABS, bez kombi All models, without ABS, without combi Все модели, без ABS, без combi	ZWP-7050	92>97		WP-441	PL	104 105 0500
WP-266	PP	105 105 1900								
WP-844	CL	105 110X 3300								
WP-830	CP	104 110X 4000								
WP-009	TL	105 105 0600								
*73	WP-009	TP	105 105 0600							
Opel Astra F										
Wszystkie modele, z ABS, bez kombi All models, with ABS, without combi Все модели, с ABS, без combi	ZWP-7006	92>97	0100P 0011P	WP-499	PL	104 105 0650				
				WP-049	PP	105 105 1900				
				WP-018	TL	105 105 0650				
				WP-018	TP	105 105 0650				
				0011T	WP-829	CL	104 110X 3550			
				*73	0087T	WP-845	CP	105 110X 3900		
				Opel Astra F						
kombi, bez ABS combi, without ABS combi, без ABS	ZWP-7007	92>97	0100P 0011P	WP-441	PL	104 105 0500				
				WP-049	PP	105 105 1900				
				WP-260	TL	104 105 0850				
				WP-018	TP	105 105 0650				
				WP-018	ZTL	105 105 0650				
				WP-018	ZTP	105 105 0650				
				0011T	WP-046	CL	105 105 3500			
				0087T	WP-021	CP	104 105 3600			

MARKA SAMOCHODU
CAR MODEL
МОДЕЛЬ АВТОМБИЯ

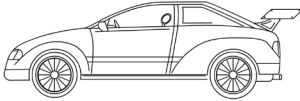

NUMER ZESTAWU
SET NUMBER
НОМЕР НАБОРА

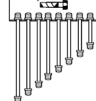

ROK PRODUKCJI
PRODUCTION YEAR
ГОД ВЫПУСКА АВТОМБИЯ



ODPOWIETRNIK
BLEEDER SCREW
ШТУЦЕР ПРОКАЧКИ ТОРМОЗОВ

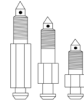

INDEKS
INDEX
ИНДЕКС



POŁOŻENIE
LOCATION
МЕСТО

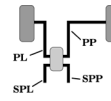

OPIS
DESCRIPTION
ОПИСАНИЕ

ZŁĄCZKA FITTING
FITTING
НАКОНЕЧНИК
ZŁĄCZKA FITTING
FITTING
НАКОНЕЧНИК
DŁUGOŚĆ LENGTH
ДЛИНА

Opel Astra F	Opel Astra G	Opel Campo	Opel Campo	Opel Campo	Opel Campo	Opel Comodore C	Opel Comodore C	Opel Comodore C	Opel Corsa A	Opel Corsa A
kombi, z ABS combi, with ABS combi, с ABS	Wszystkie modele All models Все модели	Wszystkie modele All models Все модели	2.2, 2.3, 2.5, 3.1	2.3, 2.5	3.1	Wszystkie modele All models Все модели Nr 11099064	Wszystkie modele All models Все модели Nr 11099065-D1000028	Wszystkie modele All models Все модели Nr D1000029	Wszystkie modele, do Nr N4000000 All models, to no.N4000000 Все модели, к нет.N4000000	Wszystkie modele, od Nr N4000001 All models, from no.N4000001 Все модели, от нет.N4000001
ZWP-7008	ZWP-7009	ZWP-7010	ZWP-7010	ZWP-7010	ZWP-7010	ZWP-7014	ZWP-7015	ZWP-7016	ZWP-7017	ZWP-7018
92>97	04.98>05	88>09.92	10.92>06.94	07.94>08.01	07.94>08.01	78>80	81>83	83>87	09.82>85	86>92
0100P 0011P 0011T 0087T	0015P 0039T 0100T	0019P 0017T	0019P 0017T	0019P 0017T	0019P 0017T	0010P 0015T	0010P 0015T	0010P 0015T	090P 0015T	0100P 0015T
WP-283 WP-428 WP-309 WP-005 WP-018 WP-018 WP-308 WP-592	WP-027 WP-266 WP-188 WP-005 WP-005 WP-492 WP-387 WP-113 WP-716	WP-126 WP-120 WP-132 WP-120 WP-824	WP-126 WP-120 WP-132 WP-120 WP-824	WP-126 WP-120 WP-132 WP-120 WP-824	WP-126 WP-134 WP-132 WP-120 WP-824	WP-043 WP-043 WP-009 WP-049 WP-047 WP-018 WP-712	WP-009 WP-266 WP-018 WP-265 WP-712	WP-009 WP-049 WP-018 WP-265 WP-712	WP-017 WP-034 WP-009 WP-009 WP-021 WP-253	WP-017 WP-254 WP-009 WP-009 WP-255 WP-253
PL PP TL TP ZTL ZTP CL CP	PL PP TP ZTL ZTP SPL SPP CL CP	PL PP TL TP CC	PL PP TL TP CC	PL PP TL TP CC	PL PP TL TP CC	ZPL ZPP PL PP TL TP CC	PL PP TL TP CC	PL PP TL TP CC	PL PP TL CL CP	PL PP TL TP CL CP
104 105 0550 105 105 2050 104 105 0700 105 105 0450 105 105 0650 105 105 0650 104 105 3700 104 105 3850	105 105 1250 104 105 1900 105 106 1250 105 105 0450 105 105 0450 104 105 1250 105 106 1200 105 106 1850 105 106 2150	116 116 0900 116 116 0550 116 116 1050 116 116 0550 116 116 3350	116 116 0900 116 116 0550 116 116 1050 116 116 0550 116 116 3350	116 116 0900 116 116 0550 116 116 1050 116 116 0550 116 116 3350	116 116 0900 116 116 0500 116 116 1050 116 116 0550 116 116 3350	105 105 0200 105 105 0200 105 105 0600 105 105 1900 105 105 1000 105 105 0650 105 105 4050	105 105 0600 104 105 1900 105 105 0650 105 105 0950 105 105 4050	105 105 0600 105 105 1900 105 105 0650 105 105 0950 105 105 4050	105 105 0500 105 105 1200 105 105 0600 105 105 0600 105 105 3600 105 105 4200	105 105 0500 104 105 1150 105 105 0600 105 105 0600 104 105 3600 105 105 4200

MARKA SAMOCHODU
CAR MODEL
МОДЕЛЬ АВТОМБИЯ

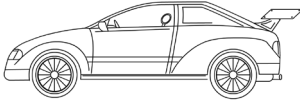

NUMER ZESTAWU
SET NUMBER
НОМЕР НАБОРА

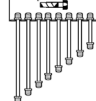

ROK PRODUKCJI
PRODUCTION YEAR
ГОД ВЫПУСКА АВТОМБИЯ



ODPOWIETRZNIK
BLEEDER SCREW
ШТУЦЕР ПРОКАЧКИ ТОРМОЗОВ

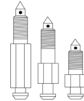

INDEKS
INDEX
ИНДЕКС



POŁOŻENIE
LOCATION
МЕСТО

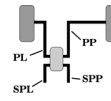

OPIS
DESCRIPTION
ОПИСАНИЕ

ZŁĄCZKA ZŁĄCZKA DŁUGOŚĆ
FITTING FITTING LENGTH
НАКОНЕЧНИК НАКОНЕЧНИК ДЛИНА

Opel Corsa B							
Wszystkie modele, bez ABS All models, without ABS Все модели, без ABS	ZWP-7019	04.93>08.00	0100P	WP-131	PL	116 116 0700	
				WP-222	PP	116 116 1650	
				WP-132	TL	116 116 1050	
				WP-123	TP	116 116 0450	
				WP-009	ZTL	105 105 0600	
				WP-009	ZTP	105 105 0600	
				WP-1694	CL	108 116 2850	
				WP-1695	CP	108 116 3250	
			0015T				
Opel Corsa B							
Wszystkie modele, z ABS All models, with ABS Все модели, с ABS	ZWP-7020	04.93>08.00	0100P	WP-353	PL	105 116 0950	
				WP-484	PP	104 105 2000	
				WP-314	TL	104 105 1000	
				WP-579	TP	105 116 0400	
				WP-018	ZTL	105 105 0650	
				WP-018	ZTP	105 105 0650	
				WP-1669	CL	104 108 3200	
				WP-1675	CP	105 108 3500	
				WP-501	STL	104 105 0900	
				WP-742	STP	105 116 1200	
							0015T
Opel Corsa C							
Wszystkie modele, z ABS All models, with ABS Все модели, с ABS	ZWP-7021	09.00>08.03	0100P	WP-353	PL	105 116 0950	
				WP-909	PP	105 116 2000	
				WP-809	TL	116 116 1150	
				WP-141	ZTL	116 116 0600	
				WP-141	ZTP	116 116 0600	
				WP-353	CL	105 116 0950	
				WP-353	CP	116 116 0950	
				WP-1693	STL	108 116 2050	
				WP-1692	STP	108 108 2150	
			0015T				
Opel Kadett C							
Wszystkie modele All models Все модели	ZWP-7022	73>07.79	0088P 0090P	WP-041	PL	105 105 0350	
				WP-034	PP	105 105 1200	
				WP-009	TL	105 105 0600	
				WP-002	TP	105 105 0850	
				WP-390	SP	105 105 2250	
				WP-045	ST	105 105 0400	
							0015T
*68 *71							
Opel Kadett C							
Wszystkie modele All models Все модели	ZWP-7023	73>07.79	0088P 0090P	WP-017	PL	105 105 0500	
				WP-003	PP	105 105 1400	
				WP-003	TL	105 105 0600	
				WP-002	TP	105 105 0850	
				WP-706	SP	105 105 2450	
				WP-045	ST	105 105 0400	
							0015T
*68 *72							
Opel Kadett C							
Wszystkie modele All models Все модели	ZWP-7024	73>07.79	0088P 0090P	WP-043	ZPL	105 105 0200	
				WP-043	ZPP	105 105 0200	
				WP-005	PL	105 105 0450	
				WP-003	PP	105 105 1400	
				WP-009	TL	105 105 0600	
				WP-002	TP	105 105 0850	
				WP-706	SP	105 105 2450	
				WP-045	ST	105 105 0400	
							0015T
*69 *72							
Opel Kadett D							
Hatchback 1.0, 1.2, 1.3N Nr D2500063, D5000000	ZWP-7025	78>83	0090P	WP-117	PL	105 105 0750	
				WP-256	PP	105 105 1750	
				WP-009	TL	105 105 0600	
				WP-006	TP	105 105 0600	
				WP-040	CL	105 105 3300	
				WP-253	CP	105 105 4200	
			0015T				
Opel Kadett D							
Hatchback 1.0, 1.2, 1.3N Nr D2500064, D5000001	ZWP-7026	83>84	0090P	WP-013	PL	105 105 0900	
				WP-256	PP	105 105 1750	
				WP-018	TL	105 105 0650	
				WP-018	TP	105 105 0650	
				WP-040	CL	105 105 3300	
				WP-253	CP	105 105 4200	
			0015T				
Opel Kadett D							
Hatchback 1.3S Nr D2500063, D5000000	ZWP-7027	78>83	0090P	WP-117	PL	105 105 0750	
				WP-010	PP	105 105 1850	
				WP-028	TL	105 105 0550	
				WP-258	TP	104 105 0450	
				WP-009	ZTL	105 105 0600	
				WP-009	ZTP	105 105 0600	
				WP-021	CL	105 105 3600	
				WP-257	CP	105 105 4500	
			0015T				

MARKA SAMOCHODU
CAR MODEL
МОДЕЛЬ АВТОМБИЯ

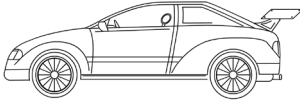

NUMER ZESTAWU
SET NUMBER
НОМЕР НАБОРА

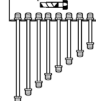

ROK PRODUKCJI
PRODUCTION YEAR
ГОД ВЫПУСКА АВТОМБИЯ



ODPOWIETRZNIK
BLEEDER SCREW
ШТУЦЕР ПРОКАЧКИ ТОРМОЗОВ

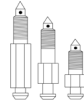

INDEKS
INDEX
ИНДЕКС



POŁOŻENIE
LOCATION
МЕСТО

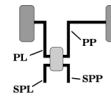

OPIS
DESCRIPTION
ОПИСАНИЕ

ZŁĄCZKA ZŁĄCZKA DŁUGOŚĆ
FITTING FITTING LENGTH
НАКОНЕЧНИК НАКОНЕЧНИК ДЛИНА

Opel Kadett D	Opel Kadett D	Opel Kadett D	Opel Kadett D	Opel Kadett D	Opel Kadett E	Opel Kadett E	Opel Kadett E	Opel Kadett E	Opel Manta B		
Hatchback 1.3S Nr D2500064, D5000001	ZWP-7028	83>84	0090P	WP-013	PL	105 105 0900	0015T	WP-013	0088P		
				WP-023	PP	105 105 1800		WP-043		ZPL	105 105 0200
				WP-028	TL	105 105 0550		WP-045		PL	105 105 0400
				WP-258	TP	104 105 0450		WP-003		PP	105 105 1400
				WP-009	ZTL	105 105 0600		WP-018		TL	105 105 0650
				WP-009	ZTP	105 105 0600		WP-013		TP	105 105 0900
				WP-021	CL	105 105 3600		WP-004		SP	105 105 3100
				WP-257	CP	105 105 4500		WP-017		ST	105 105 0500
Hatchback, Caravan 1.6 Diesel	ZWP-7029	80>84	0090P	WP-019	PL	105 105 1000	0015T	WP-019	0090P		
				WP-012	PP	105 105 1650		WP-012		PP	105 105 1650
				WP-009	TL	105 105 0600		WP-026		TL	104 105 0850
				WP-009	TP	105 105 0600		WP-009		TP	105 105 0600
				WP-029	CL	105 105 3200		WP-009		ZTL	105 105 0600
				WP-712	CP	105 105 4050		WP-009		ZTP	105 105 0600
Caravan Nr D2500063, D5000000	ZWP-7030	78>83	0090P	WP-033	PL	105 105 0700	0015T	WP-033	0090P		
				WP-256	PP	105 105 1750		WP-256		PP	105 105 1750
				WP-260	TL	104 105 0850		WP-260		TL	104 105 0850
				WP-009	TP	105 105 0600		WP-018		TP	105 105 0650
				WP-009	ZTL	105 105 0600		WP-018		ZTL	105 105 0650
				WP-009	ZTP	105 105 0600		WP-018		ZTP	105 105 0650
				WP-030	CL	105 105 3700		WP-030		CL	105 105 3700
				WP-595	CP	104 105 4750		WP-595		CP	104 105 4750
Caravan Nr D2500064, D5000001	ZWP-7031	83>84	0090P	WP-013	PL	105 105 0900	0015T	WP-013	0090P		
				WP-256	PP	105 105 1750		WP-256		PP	105 105 1750
				WP-260	TL	104 105 0850		WP-260		TL	104 105 0850
				WP-018	TP	105 105 0650		WP-018		TP	105 105 0650
				WP-018	ZTL	105 105 0650		WP-018		ZTL	105 105 0650
				WP-018	ZTP	105 105 0650		WP-018		ZTP	105 105 0650
				WP-030	CL	105 105 3700		WP-030		CL	105 105 3700
				WP-595	CP	104 105 4750		WP-595		CP	104 105 4750
Hatchback, Sedan	ZWP-7032	84>91	0090P	WP-260	PL	104 105 0850	0015T	WP-260	0090P		
				WP-256	PP	105 105 1750		WP-256		PP	105 105 1750
				WP-009	TL	105 105 0600		WP-009		TL	105 105 0600
				WP-009	TP	105 105 0600		WP-009		TP	105 105 0600
				WP-029	CL	105 105 3200		WP-029		CL	105 105 3200
				WP-594	CP	104 105 4450		WP-594		CP	104 105 4450
2xM10+2xM12 przy cylindrze głównym 2xM10+2xM12 at main cylinder 2XM10+2XM12 при главном цилиндре	0011P	0087T	0015T	WP-002	PL	105 105 0850	0015T	WP-002	0090P		
				WP-256	PP	105 105 1750		WP-256		PP	105 105 1750
				WP-009	TL	105 105 0600		WP-009		TL	105 105 0600
				WP-009	TP	105 105 0600		WP-009		TP	105 105 0600
				WP-029	CL	105 105 3200		WP-029		CL	105 105 3200
				WP-594	CP	104 105 4450		WP-594		CP	104 105 4450
Hatchback, Sedan	ZWP-7033	84>91	0090P	WP-002	PL	105 105 0850	0015T	WP-002	0090P		
				WP-256	PP	105 105 1750		WP-256		PP	105 105 1750
				WP-009	TL	105 105 0600		WP-009		TL	105 105 0600
				WP-009	TP	105 105 0600		WP-009		TP	105 105 0600
				WP-029	CL	105 105 3200		WP-029		CL	105 105 3200
				WP-257	CP	105 105 4500		WP-257		CP	105 105 4500
4xM12 przy cylindrze głównym 4xM12 at main cylinder 4XM12 при главном цилиндре	0011P	0087T	0015T	WP-260	PL	104 105 0850	0087T	WP-260	0090P		
				WP-012	PP	105 105 1650		WP-012		PP	105 105 1650
				WP-264	TL	104 105 0750		WP-264		TL	104 105 0750
				WP-028	TP	105 105 0550		WP-028		TP	105 105 0550
				WP-009	ZTL	105 105 0600		WP-009		ZTL	105 105 0600
				WP-009	ZTP	105 105 0600		WP-009		ZTP	105 105 0600
Caravan	ZWP-7034	84>91	0090P	WP-021	CL	105 105 3600	0087T	WP-021	0090P		
				WP-263	CP	104 104 4800		WP-263		CP	104 104 4800
				WP-026	TL	104 105 0750		WP-026		TL	104 105 0750
				WP-028	TP	105 105 0550		WP-028		TP	105 105 0550
				WP-009	ZTL	105 105 0600		WP-009		ZTL	105 105 0600
				WP-009	ZTP	105 105 0600		WP-009		ZTP	105 105 0600
2xM10+2xM12 przy cylindrze głównym 2xM10+2xM12 at main cylinder 2XM10+2XM12 при главном цилиндре	0011P	0087T	0015T	WP-012	PP	105 105 1650	0015T	WP-012	0090P		
				WP-264	TL	104 105 0750		WP-264		TL	104 105 0750
				WP-028	TP	105 105 0550		WP-028		TP	105 105 0550
				WP-009	ZTL	105 105 0600		WP-009		ZTL	105 105 0600
				WP-009	ZTP	105 105 0600		WP-009		ZTP	105 105 0600
				WP-021	CL	105 105 3600		WP-021		CL	105 105 3600
Caravan	ZWP-7035	84>91	0090P	WP-044	CP	105 105 4800	0015T	WP-044	0090P		
				WP-002	PL	105 105 0850		WP-002		PL	105 105 0850
				WP-012	PP	105 105 1650		WP-012		PP	105 105 1650
				WP-264	TL	104 105 0750		WP-264		TL	104 105 0750
				WP-028	TP	105 105 0550		WP-028		TP	105 105 0550
				WP-009	ZTL	105 105 0600		WP-009		ZTL	105 105 0600
4xM12 przy cylindrze głównym 4xM12 at main cylinder 4XM12 при главном цилиндре	0011P	0087T	0015T	WP-009	ZTP	105 105 0600	0015T	WP-009	0090P		
				WP-009	ZTL	105 105 0600		WP-009		ZTL	105 105 0600
				WP-021	CL	105 105 3600		WP-021		CL	105 105 3600
				WP-044	CP	105 105 4800		WP-044		CP	105 105 4800
				WP-002	PL	105 105 0850		WP-002		PL	105 105 0850
				WP-012	PP	105 105 1650		WP-012		PP	105 105 1650

MARKA SAMOCHODU
CAR MODEL
МОДЕЛЬ АВТОМБИЯ

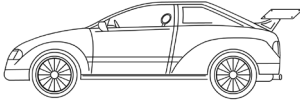

NUMER ZESTAWU
SET NUMBER
НОМЕР НАБОРА

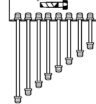

ROK PRODUKCJI
PRODUCTION YEAR
ГОД ВЫПУСКА АВТОМБИЯ



ODPOWIETRZNIK
BLEEDER SCREW
ШТУЦЕР ПРОКАЧКИ ТОРМОЗОВ

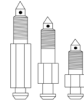

INDEKS
INDEX
ИНДЕКС



POŁOŻENIE
LOCATION
МЕСТО

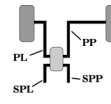

OPIS
DESCRIPTION
ОПИСАНИЕ

ZŁĄCZKA ZŁĄCZKA DŁUGOŚĆ
FITTING FITTING LENGTH
НАКОНЕЧНИК НАКОНЕЧНИК ДЛИНА

MARKA SAMOCHODU CAR MODEL МОДЕЛЬ АВТОМБИЯ	NUMER ZESTAWU SET NUMBER НОМЕР НАБОРА	ROK PRODUKCJI PRODUCTION YEAR ГОД ВЫПУСКА АВТОМБИЯ	ODPOWIETRZNIK BLEEDER SCREW ШТУЦЕР ПРОКАЧКИ ТОРМОЗОВ	INDEKS INDEX ИНДЕКС	POŁOŻENIE LOCATION МЕСТО	OPIS DESCRIPTION ОПИСАНИЕ				
Opel Manta B										
1.6 Aut., 1.6S, 1.9, 2.0	ZWP-7002	75>81	0088P 0090P 0015T	WP-043	ZPL	105 105 0200				
				WP-043	ZPP	105 105 0200				
				WP-045	PL	105 105 0400				
				WP-196	PP	105 105 1300				
				WP-019	TL	105 105 1000				
				WP-009	TP	105 105 0600				
				WP-029	SP	105 105 3200				
				WP-045	ST	105 105 0400				
Opel Manta B										
Wszystkie modele All models Все модели	ZWP-7038	82>88	0088P 0090P 0015T	WP-041	PL	105 105 0350				
				WP-027	PP	105 105 1250				
				WP-009	TL	105 105 0600				
				WP-265	TP	105 105 0950				
				WP-712	SP	105 105 4050				
				WP-045	ST	105 105 0400				
Opel Omega A										
1.8, 2.0, 2.3, 2.4 bez ABS without ABS без ABS	ZWP-7039	06.86>93	0090P 0011P 0087T	WP-009	PL	105 105 0600				
				WP-049	PP	105 105 1900				
				WP-041	TL	105 105 0350				
				WP-018	TP	105 105 0650				
				WP-018	ZTL	105 105 0650				
				WP-018	ZTP	105 105 0650				
Opel Omega B	ZWP-7053	94>97		WP-009	PL	105 105 0600				
				WP-399	PP	104 105 2300				
				WP-005	TL	105 105 0450				
				WP-024	TP	105 105 0800				
				WP-117	ZTL	105 105 0750				
				WP-117	ZTP	105 105 0750				
				WP-030	CC	105 105 3700				
				WP-1128	POM ŁĄCZ P	104 104 0540				
				WP-929	POM ŁĄCZ T	105 105 0560				
				Opel Omega B	ZWP-7054	97>		WP-009	PL	105 105 0600
WP-399	PP	104 105 2300								
WP-117	ZTL	105 105 0750								
WP-117	ZTP	105 105 0750								
WP-046	CL	105 105 3500								
WP-025	CP	105 105 4300								
WP-1128	POM ŁĄCZ P	104 104 0540								
WP-929	POM ŁĄCZ T	105 105 0560								
Opel Rekord D										
1.7, 1.9N	ZWP-7040	72>78	0088P 0015T					WP-117	PL	105 105 0750
				WP-049	PP	105 105 1900				
				WP-018	TL	105 105 0650				
				WP-047	TP	105 105 1000				
				WP-029	CC	105 105 3200				
Opel Rekord D										
1.9S, 2.0, Diesel	ZWP-7041	72>78	0088P 0015T	WP-117	PL	105 105 0750				
				WP-049	PP	105 105 1900				
				WP-018	TL	105 105 0650				
				WP-019	TP	105 105 1000				
				WP-046	CC	105 105 3500				
Opel Rekord E										
Sedan Nr 11099064	ZWP-7014	77>80	0088P 0099P 0015T	WP-043	ZPL	105 105 0200				
				WP-043	ZPP	105 105 0200				
				WP-009	PL	105 105 0600				
				WP-049	PP	105 105 1900				
				WP-047	TL	105 105 1000				
				WP-018	TP	105 105 0650				
				WP-712	CC	105 105 4050				
Opel Rekord E										
Caravan Nr 11099064	ZWP-7043	77>80	0088P 0090P 0015T	WP-043	ZPL	105 105 0200				
				WP-043	ZPP	105 105 0200				
				WP-009	PL	105 105 0600				
				WP-049	PP	105 105 1900				
				WP-047	TL	105 105 1000				
				WP-117	TP	105 105 0750				
				WP-712	CC	105 105 4050				
Opel Rekord E										
Wszystkie modele All models Все модели Nr 11099065-d1000028	ZWP-7015	81>83	0088P 0090P 0015T	WP-009	PL	105 105 0600				
				WP-266	PP	104 105 1900				
				WP-018	TL	105 105 0650				
				WP-265	TP	105 105 0950				
				WP-712	CC	105 105 4050				

MARKA SAMOCHODU
CAR MODEL
МОДЕЛЬ АВТОМБИЯ

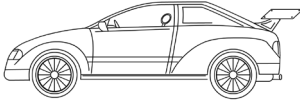

NUMER ZESTAWU
SET NUMBER
НОМЕР НАБОРА

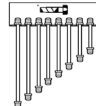

ROK PRODUKCJI
PRODUCTION YEAR
ГОД ВЫПУСКА АВТОМБИЯ



ODPOWIETRZNIK
BLEEDER SCREW
ШТУЦЕР ПРОКАЧКИ ТОРМОЗОВ

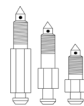

INDEKS
INDEX
ИНДЕКС



POŁOŻENIE
LOCATION
МЕСТО

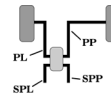

OPIS
DESCRIPTION
ОПИСАНИЕ

ZŁĄCZKA ZŁĄCZKA DŁUGOŚĆ
FITTING FITTING LENGTH
НАКОНЕЧНИК НАКОНЕЧНИК ДЛИНА

Opel Rekord E						
Wszystkie modele All models Все модели Nr D1000029	ZWP-7016	83>87	0088P 0090P 0015T	WP-009	PL	105 105 0600
				WP-049	PP	105 105 1900
				WP-018	TL	105 105 0650
				WP-265	TP	105 105 0950
				WP-712	CC	105 105 4050
Opel Vectra A						
1.4, 1.6, 1.7, 1.8, 2.0 bez ABS without ABS без ABS	ZWP-7046	89>92	0011P 0090P 0015T	WP-309	PL	104 105 0700
				WP-049	PP	105 105 1900
				WP-024	TL	105 105 0800
				WP-024	TP	105 105 0800
				WP-004	CL	105 105 3100
WP-593	CP	104 105 4250				
Opel Vectra B						
Wszystkie modele All models Все модели	ZWP-7047	95>03.02	0011P 0087T	WP-283	PL	104 105 0550
				WP-049	PP	105 105 1900
				WP-034	TL	105 105 1200
				WP-017	ZTL	105 105 0500
				WP-017	ZTP	105 105 0500
				WP-521	SPL	104 106 1200
				WP-047	SPP	105 105 1500
				WP-529	STL	105 106 2800
				WP-456	STP	105 106 2600
Opel Vectra C						
Wszystkie modele All models Все модели	ZWP-7051	04.02>	0039P 0039T	WP-479	PL	104 105 1200
				WP-266	PP	105 105 1900
				WP-483	SPL	104 106 1750
				WP-491	SPP	105 105 1800
				WP-1672	CL	105 106 2450
				WP-328	CP	105 106 3200
				WP-023	TL	105 105 1800
Opel Vivaro						
Wszystkie modele, z ABS All models, with ABS Все модели, с ABS	ZWP-7052	08.01>	0015P 0039T 0100T	WP-484	PL	104 105 2000
				WP-014	PP	105 105 2400
				WP-398	CL	104 105 2100
				WP-016	CP	105 105 2900
				WP-028	TL	105 105 0550
				WP-028	TP	105 105 0550
Opel Zafira						
Wszystkie modele All models Все модели *66	ZWP-7048	04.99>	0015P 0039T 0100T	WP-027	PL	105 105 1250
				WP-266	PP	104 105 1900
				WP-188	TP	105 106 1250
				WP-005	ZTL	105 105 0450
				WP-005	ZTP	105 105 0450
				WP-113	CL	105 106 1850
				WP-716	CP	105 106 2150
				WP-492	STL	104 105 1250
				WP-188	STP	105 106 1250
				Peugeot 104		
	ZWP-7101	73>83	0069P 0053P 0053T	WP-013	PL	105 105 0900
				WP-027	PP	105 105 1250
				WP-045	TP	105 105 0400
				WP-028	ZTL	105 105 0550
				WP-028	ZTP	105 105 0550
				WP-049	CC	105 105 1900
Peugeot 106 (S1)						
Wszystkie modele, bez ABS All models, without ABS Все модели, без ABS	ZWP-7102	09.91>04.96	0015P 0053P 0019P 0053T	WP-019	PL	105 105 1000
				WP-003	PP	105 105 1400
				WP-441	TL	104 105 0500
				WP-441	TP	104 105 0500
				WP-188	SPL	105 106 1250
				WP-196	SPP	105 105 1300
				WP-390	STL	105 105 2250
				WP-588	STP	104 105 3050
Peugeot 106 (S1)						
Wszystkie modele, z ABS All models, with ABS Все модели, с ABS	ZWP-7103	09.91>04.96	0015P 0053P 0019P 0053T	WP-013	PL	105 105 0900
				WP-039	PP	105 105 1550
				WP-284	TL	104 105 0300
				WP-453	TP	104 105 0250
				WP-017	ZTL	105 105 0500
				WP-017	ZTP	105 105 0500
				WP-109	SPL	105 106 1100
				WP-115	SPP	105 105 1150
				WP-390	STL	105 105 2250
				WP-588	STP	104 105 3050

MARKA SAMOCHODU
CAR MODEL
МОДЕЛЬ АВТОМБИЯ

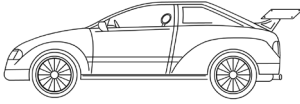

NUMER ZESTAWU
SET NUMBER
НОМЕР НАБОРА

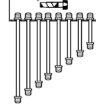

ROK PRODUKCJI
PRODUCTION YEAR
ГОД ВЫПУСКА АВТОМБИЯ



ODPOWIETRZNIK
BLEEDER SCREW
ШТУЦЕР ПРОКАЧКИ ТОРМОЗОВ

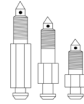

INDEKS
INDEX
ИНДЕКС



POŁOŻENIE
LOCATION
МЕСТО

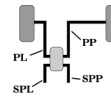

OPIS
DESCRIPTION
ОПИСАНИЕ

ZŁĄCZKA ZŁĄCZKA DŁUGOŚĆ
FITTING FITTING LENGTH
НАКОНЕЧНИК НАКОНЕЧНИК ДЛИНА

MARKA SAMOCHODU CAR MODEL МОДЕЛЬ АВТОМБИЯ	NUMER ZESTAWU SET NUMBER НОМЕР НАБОРА	ROK PRODUKCJI PRODUCTION YEAR ГОД ВЫПУСКА АВТОМБИЯ	ODPOWIETRZNIK BLEEDER SCREW ШТУЦЕР ПРОКАЧКИ ТОРМОЗОВ	INDEKS INDEX ИНДЕКС	POŁOŻENIE LOCATION МЕСТО	OPIS DESCRIPTION ОПИСАНИЕ				
Peugeot 106 (S2)										
Wszystkie modele, bez ABS All models, without ABS Все модели, без ABS PR7664 *67	ZWP-7104	05.96>10.97	0015P 0053P 0069T 0053T	WP-024	PL	105 105 0800				
				WP-435	PP	105 105 1600				
				WP-009	TL	105 105 0600				
				WP-009	TP	105 105 0600				
				WP-435	SPL	105 105 1600				
				WP-042	SPP	105 105 1700				
				WP-031	STL	105 105 2200				
				WP-599	STP	104 106 2100				
				Peugeot 106 (S2)						
				Wszystkie modele, bez ABS All models, without ABS Все модели, без ABS PR7664 *66	ZWP-7105	05.96>10.97	0015P 0053P 0069T 0053T	WP-024	PL	105 105 0800
WP-435	PP	105 105 1600								
WP-441	TL	104 105 0500								
WP-441	TP	104 105 0500								
WP-435	SPL	105 105 1600								
WP-042	SPP	105 105 1700								
WP-716	STL	105 106 2150								
WP-529	STP	105 106 2800								
Peugeot 106 (S2)										
Wszystkie modele, z ABS All models, with ABS Все модели, с ABS *67	ZWP-7106	05.96>07.04	0015P 0053P 0069T 0053T					WP-283	PL	104 105 0550
				WP-196	PP	105 105 1300				
				WP-041	TL	105 105 0350				
				WP-485	TP	104 105 1350				
				WP-009	ZTL	105 105 0600				
				WP-009	ZTP	105 105 0600				
				WP-479	SPL	104 105 1200				
				WP-003	SPP	105 105 1400				
				WP-187	STL	105 106 2200				
				WP-599	STP	104 106 2100				
Peugeot 106 (S2)										
Wszystkie modele, z ABS All models, with ABS Все модели, с ABS *66	ZWP-7107	05.96>07.04	0015P 0053P 0069T 0053T	WP-283	PL	104 105 0550				
				WP-196	PP	105 105 1300				
				WP-041	TL	105 105 0350				
				WP-485	TP	104 105 1350				
				WP-017	ZTL	105 105 0500				
				WP-017	ZTP	105 105 0500				
				WP-479	SPL	104 105 1200				
				WP-003	SPP	105 105 1400				
				WP-187	STL	105 106 2200				
				WP-599	STP	104 106 2100				
Peugeot 204, 304S, 304										
Coupe *69 *72	ZWP-7108	73>77		WP-279	ZPL	109 115 0300				
				WP-279	ZPP	109 115 0300				
				WP-277	PL	115 115 0650				
				WP-267	PP	115 115 0900				
				WP-269	TL	115 115 0400				
				WP-277	TP	115 115 0650				
				WP-282	ZTL	115 115 0450				
				WP-282	ZTP	115 115 0450				
				WP-281	CC	114 115 2300				
Peugeot 205										
Wszystkie modele, bez GTI All models, without GTI Все модели, без GTI	ZWP-7109	03.83>12.97	0053P 0087P 0053T 0069T	WP-009	PL	105 105 0600				
				WP-003	PP	105 105 1400				
				WP-283	TL	104 105 0550				
				WP-283	TP	104 105 0550				
				WP-004	CL	105 105 3100				
				WP-571	CP	105 105 3850				
				Peugeot 206						
Wszystkie modele All models Все модели	ZWP-7110	09.98>	0053P 0069P 0053T 0069T	WP-489	PL	104 105 1100				
				WP-043	PP	105 105 0200				
				WP-017	TL	105 105 0500				
				WP-017	TP	105 105 0500				
				WP-438	CL	105 105 4450				
				WP-510	CP	104 104 4300				
Peugeot 305										
Sedan Nr 8622709 *02	ZWP-7111	77>82	0053P 0069P 0053T 0069T	WP-041	PL	105 105 0350				
				WP-034	PP	105 105 1200				
				WP-009	TL	105 105 0600				
				WP-045	TP	105 105 0400				
				WP-028	ZTL	105 105 0550				
				WP-028	ZTP	105 105 0550				
				WP-004	CC	105 105 3100				
				Peugeot 305						
Sedan Nr 8622710	ZWP-7112	83>91	0053P 0069P 0087T 0053T 0069T	WP-013	PL	105 105 0900				
				WP-047	PP	105 105 1500				
				WP-017	TL	105 105 0500				
				WP-045	TP	105 105 0400				
				WP-017	ZTL	105 105 0500				
				WP-017	ZTP	105 105 0500				
				WP-023	SP	105 105 1800				
				WP-049	ST	105 105 1900				

MARKA SAMOCHODU
CAR MODEL
МОДЕЛЬ АВТОМБИЯ

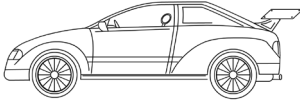

NUMER ZESTAWU
SET NUMBER
НОМЕР НАБОРА

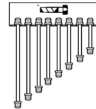

ROK PRODUKCJI
PRODUCTION YEAR
ГОД ВЫПУСКА АВТОМБИЯ



ODPOWIETRZNIK
BLEEDER SCREW
ШТУЦЕР ПРОКАЧКИ ТОРМОЗОВ

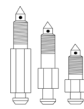

INDEKS
INDEX
ИНДЕКС



POŁOŻENIE
LOCATION
МЕСТО

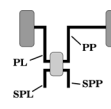

OPIS
DESCRIPTION
ОПИСАНИЕ

ZŁĄCZKA
FITTING
НАКОНЕЧНИК

ZŁĄCZKA
FITTING
НАКОНЕЧНИК

DŁUGOŚĆ
LENGTH
ДЛИНА

Peugeot 305	NUMER ZESTAWU	ROK PRODUKCJI	ODPOWIETRZNIK	INDEKS	POŁOŻENIE	OPIS
Kombi Nr 8619359 *02	ZWP-7111	77>82	0053P 0069P	WP-041	PL	105 105 0350
				WP-034	PP	105 105 1200
				WP-009	TL	105 105 0600
				WP-045	TP	105 105 0400
				WP-028	ZTL	105 105 0550
				WP-028	ZTP	105 105 0550
				WP-004	CC	105 105 3100
Peugeot 305 Kombi Nr 8619360	ZWP-7114	83>91	0053P 0069P	WP-013	PL	105 105 0900
				WP-047	PP	105 105 1500
				WP-035	TL	105 105 1100
				WP-117	TP	105 105 0750
				WP-041	ZTL	105 105 0350
				WP-041	ZTP	105 105 0350
				WP-031	SP	105 105 2200
WP-049	ST	105 105 1900				
Peugeot 306 Wszystkie modele, bez ABS All models, without ABS Все модели, без ABS	ZWP-7115	93>09.96	0019P 0053P	WP-018	PL	105 105 0650
				WP-440	PP	105 105 2150
				WP-499	TL	104 105 0650
				WP-009	TP	105 105 0600
				WP-590	SPL	104 105 3300
				WP-591	SPP	104 105 3450
				WP-721	STL	105 107 0700
WP-720	STP	105 107 0650				
*66	ZWP-7116	10.96>04.02	0019P 0053P	WP-018	PL	105 105 0650
				WP-440	PP	105 105 2150
				WP-499	TL	104 105 0650
				WP-009	TP	105 105 0600
				WP-008	SPL	105 105 3000
				WP-590	SPP	104 105 3300
				WP-721	STL	105 107 0700
WP-720	STP	105 107 0650				
*66	ZWP-7117	10.96>04.02	0019P 0053P	WP-009	PL	105 105 0600
				WP-1671	PP	105 106 1650
				WP-479	TL	104 105 1200
				WP-453	TP	105 105 0250
				WP-009	ZTL	105 105 0600
				WP-009	ZTP	105 105 0600
				WP-109	SPL	105 106 1100
WP-035	SPP	105 105 1100				
WP-709	STL	104 105 3150				
WP-020	STP	104 105 3400				
*66	ZWP-7118	10.96>04.02	0019P 0053P	WP-009	PL	105 105 0600
				WP-1671	PP	105 106 1650
				WP-479	TL	104 105 1200
				WP-006	TP	105 105 0250
				WP-117	ZTL	105 105 0750
				WP-117	ZTP	105 105 0750
				WP-109	SPL	105 106 1100
WP-035	SPP	105 105 1100				
WP-589	STL	104 105 3150				
WP-1668	STP	104 105 3400				
*67	ZWP-7119	01.01>	0015P 0087T	WP-265	PL	105 105 0950
				WP-1667	PP	104 105 2150
				WP-1625	CL	104 105 4400
				WP-713	CP	105 105 4600
				WP-013	PL	105 105 0900
				WP-1667	PP	104 105 2150
				WP-1625	CL	104 105 4400
WP-713	CP	105 105 4600				
Peugeot 306 Wszystkie modele, bez ABS All models, without ABS Все модели, без ABS Nr 10000000	ZWP-7120	09.85>89	0053P 0087P	WP-028	PL	105 105 0550
				WP-003	PP	105 105 1400
				WP-024	TP	105 105 0800
				WP-028	ZTL	105 105 0550
				WP-028	ZTP	105 105 0550
				WP-284	SP	104 105 0300
				WP-008	ST	105 105 3000

MARKA SAMOCHODU
CAR MODEL
МОДЕЛЬ АВТОМБИЯ

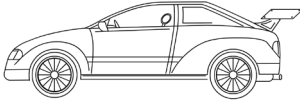

NUMER ZESTAWU
SET NUMBER
НОМЕР НАБОРА

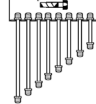

ROK PRODUKCJI
PRODUCTION YEAR
ГОД ВЫПУСКА АВТОМБИЯ



ODPOWIETRZNIK
BLEEDER SCREW
ШТУЦЕР ПРОКАЧКИ ТОРМОЗОВ

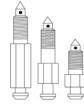

INDEKS
INDEX
ИНДЕКС



POŁOŻENIE
LOCATION
МЕСТО

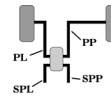

OPIS
DESCRIPTION
ОПИСАНИЕ

ZŁĄCZKA ZŁĄCZKA DŁUGOŚĆ
FITTING FITTING LENGTH
НАКОНЕЧНИК НАКОНЕЧНИК ДЛИНА

MARKA SAMOCHODU CAR MODEL МОДЕЛЬ АВТОМБИЯ	NUMER ZESTAWU SET NUMBER НОМЕР НАБОРА	ROK PRODUKCJI PRODUCTION YEAR ГОД ВЫПУСКА АВТОМБИЯ	ODPOWIETRZNIK BLEEDER SCREW ШТУЦЕР ПРОКАЧКИ ТОРМОЗОВ	INDEKS INDEX ИНДЕКС	POŁOŻENIE LOCATION МЕСТО	OPIS DESCRIPTION ОПИСАНИЕ			
Peugeot 306									
Wszystkie modele, bez ABS, bez 16V All models, without ABS, without 16V Все модели, без ABS, без 16V	ZWP-7121	90>93	0053P 0087P	WP-028	PL	105 105 0550			
				WP-027	PP	105 105 1250			
				WP-028	TP	105 105 0550			
				WP-283	ZTL	104 105 0550			
				WP-283	ZTP	104 105 0550			
				WP-475	SP	105 105 3050			
				WP-328	SP+	106 106 3200			
				WP-490	ST	104 105 0350			
				WP-005	ST+	105 105 0450			
				0053T 0069T					
Peugeot 306									
16V bez ABS without ABS без ABS	ZWP-7122	90>93	0053P 0087P	WP-028	PL	105 105 0550			
				WP-027	PP	105 105 1250			
				WP-005	TL	105 105 0450			
				WP-005	TP	105 105 0450			
				WP-028	ZTL	105 105 0550			
				WP-028	ZTP	105 105 0550			
				WP-453	SP	104 105 0250			
				WP-453	SP+	104 105 0250			
				WP-454	ST	106 106 3200			
				WP-176	ST+	105 106 3700			
0053T 0069T									
Peugeot 306									
Wszystkie modele, z ABS All models, with ABS Все модели, с ABS	ZWP-7123	90>93	0053P 0087P	WP-045	PL	105 105 0400			
				WP-047	PP	105 105 1500			
				WP-005	TL	105 105 0450			
				WP-005	TP	105 105 0450			
				WP-028	ZTL	105 105 0550			
				WP-028	ZTP	105 105 0550			
				WP-717	SP	105 106 2350			
				WP-456	SP+	105 106 2600			
				WP-453	ST	104 105 0250			
				WP-453	ST+	104 105 0250			
0053T 0069T									
Peugeot 405									
Wszystkie modele 2WD, bez ABS All models 2WD, without ABS Все модели 2WD, без ABS	ZWP-7124	88>92	0053P 0039P	WP-033	PL	105 105 0700			
				WP-018	PP	105 105 0650			
				WP-003	TL	105 105 1400			
				WP-457	TP	104 105 0400			
				WP-005	ZTL	105 105 0450			
				WP-005	ZTP	105 105 0450			
				WP-019	SP	105 105 1000			
				WP-386	SP+	105 106 1050			
				WP-014	ST	105 105 2400			
				WP-700	ST+	104 106 2400			
*66 *73									
0039T 0069T 0053T									
Peugeot 405									
Wszystkie modele 2WD, bez ABS All models 2WD, without ABS Все модели 2WD, без ABS	ZWP-7125	88>92	0053P 0039P	WP-033	PL	105 105 0700			
				WP-018	PP	105 105 0650			
				WP-003	TL	105 105 1400			
				WP-457	TP	104 105 0400			
				WP-043	ZTL	105 105 0200			
				WP-043	ZTP	105 105 0200			
				WP-019	SP	105 105 1000			
				WP-386	SP+	105 106 1050			
				WP-014	ST	105 105 2400			
				WP-700	ST+	104 106 2400			
*67 *73									
0039T 0069T 0053T									
Peugeot 405									
Wszystkie modele 2WD, bez ABS All models 2WD, without ABS Все модели 2WD, без ABS	ZWP-7126	88>92	0053P 0039P	WP-033	PL	105 105 0700			
				WP-018	PP	105 105 0650			
				WP-457	TL	104 105 0400			
				WP-457	TP	104 105 0400			
				WP-019	SP	105 105 1000			
				WP-386	SP+	105 106 1050			
				WP-040	ST	105 105 3300			
				WP-719	ST+	105 106 3650			
				*74					
				0039T 0069T 0053T					
Peugeot 405									
Wszystkie modele 2WD, z ABS All models 2WD, with ABS Все модели 2WD, с ABS	ZWP-7127	88>92	0053P 0039P	WP-017	PL	105 105 0500			
				WP-035	PP	105 105 1100			
				WP-115	TL	105 105 1150			
				WP-457	TP	104 105 0400			
				WP-043	ZTL	105 105 0200			
				WP-043	ZTP	105 105 0200			
				WP-047	SP	105 105 1500			
				WP-459	SP+	105 106 1500			
				WP-706	ST	105 105 2450			
				WP-460	ST+	104 106 2500			
0039T 0069T 0053T									

MARKA SAMOCHODU
CAR MODEL
МОДЕЛЬ АВТОМБИЯ

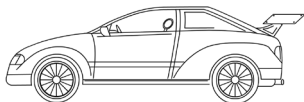

NUMER ZESTAWU
SET NUMBER
НОМЕР НАБОРА

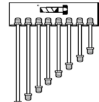

ROK PRODUKCJI
PRODUCTION YEAR
ГОД ВЫПУСКА АВТОМБИЯ



ODPOWIETRNIK
BLEEDER SCREW
ШТУЦЕР ПРОКАЧКИ ТОРМОЗОВ

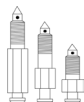

INDEKS
INDEX
ИНДЕКС



POŁOŻENIE
LOCATION
МЕСТО

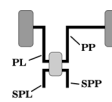

OPIS
DESCRIPTION
ОПИСАНИЕ

ZŁĄCZKA
FITTING
НАКОНЕЧНИК

ZŁĄCZKA
FITTING
НАКОНЕЧНИК

DŁUGOŚĆ
LENGTH
ДЛИНА

Peugeot 406							
Wszystkie modele, bez ABS All models, without ABS Все модели, без ABS z kompensatorem Slave *66	ZWP-7128	09.95>03.04	0039P	WP-009	PL	105 105 0600	
				WP-435	PP	105 105 1600	
				WP-499	TL	104 105 0650	
				WP-028	TP	105 105 0550	
				WP-005	ZTL	105 105 0450	
				WP-005	ZTP	105 105 0450	
				WP-428	SPL	105 105 2050	
				WP-484	SPP	104 105 2000	
				WP-092	STL	104 106 2700	
				WP-707	STP	105 105 2650	
				0069T			
				0086T			
				Peugeot 406			
Wszystkie modele, bez ABS All models, without ABS Все модели, без ABS z połączonym kompensatorem *66	ZWP-7129	09.95>03.04	0039P	WP-009	PL	105 105 0600	
				WP-435	PP	105 105 1600	
				WP-441	TL	104 105 0500	
				WP-017	TP	105 105 0500	
				WP-457	ZTL	104 105 0400	
				WP-457	ZTP	104 105 0400	
				WP-428	SPL	105 105 2050	
				WP-484	SPP	104 105 2000	
				WP-092	STL	104 106 2700	
				WP-707	STP	105 105 2650	
				0069T			
				0086T			
				Peugeot 406			
Wszystkie modele, bez ABS All models, without ABS Все модели, без ABS *67	ZWP-7128	09.95>03.04	0039P	WP-009	PL	105 105 0600	
				WP-435	PP	105 105 1600	
				WP-499	TL	104 105 0650	
				WP-028	TP	105 105 0550	
				WP-005	ZTL	105 105 0450	
				WP-005	ZTP	105 105 0450	
				WP-428	SPL	105 105 2050	
				WP-484	SPP	104 105 2000	
				WP-092	STL	104 106 2700	
				WP-707	STP	105 105 2650	
				0069T			
				0086T			
				Peugeot 406			
Wszystkie modele, z ABS All models, with ABS Все модели, с ABS Nr DAM 7510 *66	ZWP-7131	09.95>05.97	0039P	WP-499	PL	104 105 0650	
				WP-488	PP	104 105 1700	
				WP-499	TL	104 105 0650	
				WP-028	TP	105 105 0550	
				WP-005	ZTL	105 105 0450	
				WP-005	ZTP	105 105 0450	
				WP-011	SPL	105 105 2300	
				WP-717	SPP	105 106 2350	
				WP-092	STL	104 106 2700	
				WP-707	STP	105 105 2650	
				0069T			
				0086T			
				Peugeot 406			
Wszystkie modele, z ABS, bez Turbo All models, with ABS, without Turbo Все модели, с ABS, без Turbo Nr -DAM 7510 *67	ZWP-7132	09.95>05.97	0039P	WP-499	PL	104 105 0650	
				WP-488	PP	104 105 1700	
				WP-499	TL	104 105 0650	
				WP-028	TP	105 105 0650	
				WP-045	ZTL	105 105 0400	
				WP-045	ZTP	105 105 0400	
				WP-011	SPL	105 105 2300	
				WP-717	SPP	105 106 2350	
				WP-092	STL	104 106 2700	
				WP-707	STP	105 105 2650	
				0069T			
				0086T			
				Peugeot 406			
Wszystkie modele, z ABS All models, with ABS Все модели, с ABS Nr DAM 7511- *66	ZWP-7133	06.97>03.04	0039P	WP-024	PL	105 105 0800	
				WP-023	PP	105 105 1800	
				WP-499	TL	104 105 0650	
				WP-028	TP	105 105 0550	
				WP-005	ZTL	105 105 0450	
				WP-005	ZTP	105 105 0450	
				WP-390	SPL	105 105 2250	
				WP-717	SPP	105 106 2350	
				WP-092	STL	104 106 2700	
				WP-707	STP	105 105 2650	
				0069T			
				0086T			
				Peugeot 407			
	ZWP-7150	05.04>		WP-832	PL	104X 105 0850	
				WP-1740	PP	104X 105 1950	
				WP-030	CL	105 105 3700	
				WP-025	CP	105 105 4300	
Peugeot 504							
Sedan *01	ZWP-7134	71>83	0069P	WP-269	PL	115 115 0400	
				WP-267	PP	115 115 0900	
			0086P	WP-272	TL	115 115 0350	
				WP-273	TP	115 115 0600	
			0053T	WP-273	ZTL	115 115 0600	
				WP-273	ZTP	115 115 0600	
			0069T	WP-803	CC	115 115 2600	

MARKA SAMOCHODU
CAR MODEL
МОДЕЛЬ АВТОМБИЯ

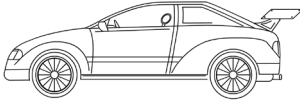

NUMER ZESTAWU
SET NUMBER
НОМЕР НАБОРА

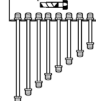

ROK PRODUKCJI
PRODUCTION YEAR
ГОД ВЫПУСКА АВТОМБИЯ



ODPOWIETRZNIK
BLEEDER SCREW
ШТУЦЕР ПРОКАЧКИ ТОРМОЗОВ

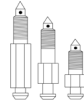

INDEKS
INDEX
ИНДЕКС



POŁOŻENIE
LOCATION
МЕСТО

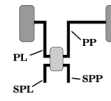

OPIS
DESCRIPTION
ОПИСАНИЕ

ZŁĄCZKA ZŁĄCZKA DŁUGOŚĆ
FITTING FITTING LENGTH
НАКОНЕЧНИК НАКОНЕЧНИК ДЛИНА

Peugeot 504						
Sedan L Nr 2058001 *02	ZWP-7135	75>83	0069P 0086P 0053T 0069T	WP-045	PL	105 105 0400
				WP-019	PP	105 105 1000
				WP-024	TL	105 105 0800
				WP-024	TP	105 105 0800
				WP-390	SP	105 105 2250
				WP-041	ST	105 105 0350
Peugeot 504						
Sedan GL Nr 2058001 *02	ZWP-7136	75>83	0069P 0086P 0053T 0069T	WP-045	PL	105 105 0400
				WP-019	PP	105 105 1000
				WP-041	TL	105 105 0350
				WP-009	TP	105 105 0600
				WP-018	ZTL	105 105 0650
				WP-018	ZTP	105 105 0650
				WP-167	CC	105 105 2600
				Peugeot 504		
D, E, F Wagon *01	ZWP-7137	79>88	0086P 0087T	WP-269	PL	115 115 0400
				WP-267	PP	115 115 0900
				WP-273	TL	115 115 0600
				WP-275	TP	115 115 1050
				WP-276	SP	115 115 2300
				WP-1629	ST	114 115 0700
Peugeot 504						
Nr 2058001 *02	ZWP-7138	75>82	0069P 0086P 0053T 0069T	WP-045	PL	105 105 0400
				WP-019	PP	105 105 1000
				WP-009	TL	105 105 0600
				WP-035	TP	105 105 1100
				WP-390	SP	105 105 2250
				WP-018	ST	105 105 0650
Peugeot 505						
Sedan *02	ZWP-7139	05.79>91	0086P 0053P 0053T	WP-009	PL	105 105 0600
				WP-428	PP	105 105 2050
				WP-041	TL	105 105 0350
				WP-018	TP	105 105 0650
				WP-018	ZTL	105 105 0650
				WP-018	ZTP	105 105 0650
				WP-014	CC	105 105 2400
Peugeot Boxer						
1000, 1400, 1800 bez ABS, krótki rozstaw osi without ABS, short wheel base без ABS, короткий колесная база	ZWP-7141	03.94>03.02	0039P 0069T	WP-035	PL	105 105 1100
				WP-115	PL	105 105 1150
				WP-014	PP	105 105 2400
				WP-706	PP	105 105 2450
				WP-1671	SP	105 106 1650
				WP-706	ST	105 105 2450
				WP-018	TL	105 105 0650
				WP-003	TP	105 105 1400
Peugeot Boxer						
1400, 1800 bez ABS, średni rozstaw osi without ABS, mid wheel base без ABS, длинная колесная база	ZWP-7142	03.94>03.02	0039P 0069T	WP-035	PL	105 105 1100
				WP-115	PL	105 105 1150
				WP-014	PP	105 105 2400
				WP-706	PP	105 105 2450
				WP-1671	SP	105 106 1650
				WP-404	ST	105 105 2550
				WP-018	TL	105 105 0650
				WP-003	TP	105 105 1400
Peugeot Boxer						
1400, 1800 bez ABS, długi rozstaw osi without ABS, long wheel base без ABS, средний колесная база	ZWP-7143	03.94>03.02	0039P 0069T	WP-035	PL	105 105 1100
				WP-115	PL	105 105 1150
				WP-014	PP	105 105 2400
				WP-706	PP	105 105 2450
				WP-1671	SP	105 106 1650
				WP-040	ST	105 105 3300
				WP-018	TL	105 105 0650
				WP-003	TP	105 105 1400
Peugeot Boxer						
Wszystkie modele z ABS, do Nr S15445357 All models with ABS, to no. S15445357 Все модели с ABS, к нет. S15445357	ZWP-7144	03.94>03.02	0039P 0069T	WP-035	PL	105 105 1100
				WP-167	PP	105 105 2600
				WP-1667	SPL	104 105 2150
				WP-1684	SPP	105 110X 2150
				WP-043	STL	105 105 0200
				WP-1696	STP	104X 105 0300
				WP-018	TL	105 105 0650
				WP-003	TP	105 105 1400

MARKA SAMOCHODU
CAR MODEL
МОДЕЛЬ АВТОМБИЯ

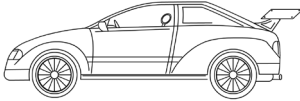

NUMER ZESTAWU
SET NUMBER
НОМЕР НАБОРА

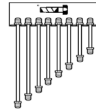

ROK PRODUKCJI
PRODUCTION YEAR
ГОД ВЫПУСКА АВТОМБИЯ



ODPOWIETRZNIK
BLEEDER SCREW
ШТУЦЕР ПРОКАЧКИ ТОРМОЗОВ

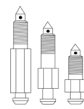

INDEKS
INDEX
ИНДЕКС



POŁOŻENIE
LOCATION
МЕСТО

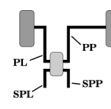

OPIS
DESCRIPTION
ОПИСАНИЕ

ZŁĄCZKA ZŁĄCZKA DŁUGOŚĆ
FITTING FITTING LENGTH
НАКОНЕЧНИК НАКОНЕЧНИК ДЛИНА

Peugeot Boxer						
330 z ABS, krótki rozstaw osi with ABS, short wheel base с ABS, короткий колесная база	ZWP-7145	04.02>	0039P	WP-019	PL	105 105 1000
				WP-706	PP	105 105 2450
				WP-491	SPL	104 105 1800
				WP-1866	SPP	105 110X 1850
				WP-036	STL	105 105 2100
				WP-1867	STP	105 110X 2200
				WP-018	TL	105 105 0650
				WP-528	TP	104X 105 1350
Peugeot Boxer						
333 z ABS, średni rozstaw osi with ABS, mid wheel base с ABS, длинная колесная база	ZWP-7146	04.02>	0039P	WP-019	PL	105 105 1000
				WP-706	PP	105 105 2450
				WP-491	SPL	104 105 1800
				WP-1866	SPP	105 110X 1850
				WP-167	STL	105 105 2600
				WP-1869	STP	105 110X 2650
				WP-018	TL	105 105 0650
				WP-528	TP	104X 105 1350
Peugeot Boxer						
335 z ABS, długi rozstaw osi with ABS, long wheel base с ABS, средний колесная база	ZWP-7147	04.02>	0039P	WP-019	PL	105 105 1000
				WP-706	PP	105 105 2450
				WP-491	SPL	104 105 1800
				WP-1866	SPP	105 110X 1850
				WP-040	STL	105 105 3300
				WP-1871	STP	105 110X 3350
				WP-018	TL	105 105 0650
				WP-528	TP	104X 105 1350
Peugeot Expert						
1.9, 2.0 Hdi krótki model short model короткая модель	ZWP-7148	02.96>	0039P	WP-002	PL	105 105 0850
				WP-013	PP	105 105 0900
				WP-506	SPL	104X 105 1250
				WP-027	SPP	105 105 1250
				WP-1729	STL	105 108 2500
				WP-1870	STP	105 110X 3100
				WP-024	TL	105 105 0800
				WP-024	TP	105 105 0800
Peugeot Expert						
1.9, 2.0 Hdi krótki model short model короткая модель	ZWP-7149	02.96>	0039P	WP-002	PL	105 105 0850
				WP-013	PP	105 105 0900
				WP-506	SPL	104X 105 1250
				WP-027	SPP	105 105 1250
				WP-1730	STL	105 108 2950
				WP-1881	STP	105 110X 3550
				WP-024	TL	105 105 0800
				WP-024	TP	105 105 0800
Peugeot Partner						
Wszystkie modele z ABS, do Nr PR8609 All models with ABS, to no. PR8609 Все модели с ABS, к нет. PR8609	ZWP-5303	07.96>04.00	0039P	WP-018	PL	105 105 0650
				WP-039	PP	105 105 1550
				WP-027	TL	105 105 1250
				WP-009	TP	105 105 0600
				WP-005	ZTL	105 105 0450
				WP-005	ZTP	105 105 0450
				WP-007	CL	105 105 3900
				WP-007	CP	105 105 3900
Peugeot Partner						
Wszystkie modele z ABS, do Nr PR8609 All models with ABS, to no. PR8609 Все модели с ABS, к нет. PR8609	ZWP-5304	07.96>04.00	0039P	WP-435	PL	105 105 1600
				WP-034	PP	105 105 1200
				WP-027	TL	105 105 1250
				WP-009	TP	105 105 0600
				WP-005	ZTL	105 105 0450
				WP-005	ZTP	105 105 0450
				WP-034	SPL	105 105 1200
				WP-027	SPP	105 105 1250
WP-007	CL	105 105 3900				
WP-007	CP	105 105 3900				
Peugeot Partner						
Wszystkie modele bez ABS, od Nr PR8610 All models without ABS, from no. PR8610 Все модели без ABS, от нет. PR8610	ZWP-5305	05.00>	0039P	WP-252	PL	105 105 1050
				WP-042	PP	105 105 1700
				WP-027	TL	105 105 1250
				WP-009	TP	105 105 0600
				WP-005	ZTL	105 105 0450
				WP-005	ZTP	105 105 0450
				WP-572	CL	105 106 3950
				WP-572	CP	105 106 3950

MARKA SAMOCHODU
CAR MODEL
МОДЕЛЬ АВТОМБИЯ

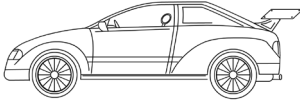

NUMER ZESTAWU
SET NUMBER
НОМЕР НАБОРА

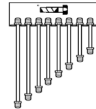

ROK PRODUKCJI
PRODUCTION YEAR
ГОД ВЫПУСКА АВТОМБИЯ



ODPOWIETRZNIK
BLEEDER SCREW
ШТУЦЕР ПРОКАЧКИ ТОРМОЗОВ

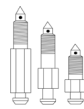

INDEKS
INDEX
ИНДЕКС



POŁOŻENIE
LOCATION
МЕСТО

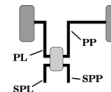

OPIS
DESCRIPTION
ОПИСАНИЕ

ZŁĄCZKA ZŁĄCZKA DŁUGOŚĆ
FITTING FITTING LENGTH
НАКОНЕЧНИК НАКОНЕЧНИК ДЛИНА

Peugeot Partner										
Wszystkie modele z ABS, od Nr PR8610 All models with ABS, from no.PR8610 Все модели с ABS, от нет.PR8610	ZWP-5306	05.00>	0039P	WP-047	PL	105 105 1500				
				WP-034	PP	105 105 1200				
				WP-027	TL	105 105 1250				
				WP-009	TP	105 105 0600				
				WP-005	ZTL	105 105 0450				
				WP-005	ZTP	105 105 0450				
				WP-019	SPL	105 105 1000				
				WP-019	SPP	105 105 1000				
				WP-572	CL	105 106 3950				
				WP-572	CP	105 106 3950				
			0069T							
Polonez LE										
1.5	ZWP-7201	05.78>87	0100P	WP-411	PL	112 112 0800				
				WP-156	PP	112 112 1700				
				WP-051	TL	112 112 0550				
				WP-154	TP	112 112 0950				
			0100T	WP-792	CC	112 112 3400				
Polonez Lucas										
	ZWP-7202		0100P	WP-117	PL	105 105 0750				
				WP-435	PP	105 105 1600				
				WP-009	TL	105 105 0600				
				WP-252	TP	105 105 1050				
				WP-006	SP	105 105 0250				
				WP-021	ST	105 105 3600				
			0100T							
Polonez Polmo										
1500	ZWP-7203	83>87	0100P	WP-787	PL	112 112 0700				
				WP-156	PP	112 112 1700				
				WP-051	TL	112 112 0550				
				WP-154	TP	112 112 0950				
				WP-791	CC	112 112 3250				
			0100T							
Polonez Truck										
	ZWP-7204		0100P	WP-052	PL	112 112 1050				
				WP-466	PP	112 112 1800				
				WP-412	TL	112 112 0600				
				WP-052	TP	112 112 1050				
				WP-467	SP	112 112 4100				
				WP-468	SP+	112 112 4350				
				WP-229	ST	112 112 0250				
							0100T			
Renault R4										
R1123, R2106 z regulatorem hamulca z lewej strony with brake regulator on left side с тормозным регулятором с левой стороны *01	ZWP-7301	65>86	0069P 0053P	WP-065	PL	109 109 0800				
				WP-336	PP	109 109 1550				
				WP-286	TL	109 109 0150				
				WP-057	TP	109 109 1100				
				WP-287	ZTL	109 109 0600				
				WP-287	ZTP	109 109 0600				
				WP-291	CC	109 109 2900				
							0053T			
Renault R4										
R1123, R2106 z rozdzielaczem with distributor с распределителем *02	ZWP-7302	76>86	0069P 0053P	WP-293	PL	109 109 0950				
				WP-294	PP	109 109 1950				
				WP-286	TL	109 109 0150				
				WP-057	TP	109 109 1100				
				WP-287	ZTL	109 109 0600				
				WP-287	ZTP	109 109 0600				
				WP-291	CL	109 109 2900				
				WP-295	CP	109 114 3000				
			0053T							
Renault R4										
R2370	ZWP-7303	76>86	0069P 0053P	WP-293	PL	109 109 0950				
				WP-294	PP	109 109 1950				
				WP-286	TL	109 109 0150				
				WP-057	TP	109 109 1100				
				WP-287	ZTL	109 109 0600				
				WP-287	ZTP	109 109 0600				
				WP-292	CL	109 109 3000				
				WP-071	CP	109 114 3100				
			0053T							
Renault R5										
Wszystkie modele All models Все модели *02	ZWP-7304	76>86	0069P 0053P	WP-296	PL	109 109 0700				
				WP-765	PP	109 109 2050				
				WP-058	TL	109 109 0450				
				WP-300	TP	109 109 0750				
				WP-287	ZTL	109 109 0600				
				WP-287	ZTP	109 109 0600				
				WP-777	CL	109 114 2950				
				WP-288	CP	109 109 2800				
							0069T			
							0053T			
Renault R5										
Wszystkie modele All models Все модели *74	ZWP-7305	85>90	0069P 0053P	WP-009	PL	105 105 0600				
				WP-035	PP	105 105 1100				
				WP-001	TL	105 105 0300				
				WP-024	TL+	105 105 0800				
				WP-009	TP	105 105 0600				
				WP-499	TP+	104 105 0650				
				WP-438	CL	105 105 4450				
				WP-405	CP	104 105 4400				
							0069T			
							0053T			

MARKA SAMOCHODU
CAR MODEL
МОДЕЛЬ АВТОМБИЯ

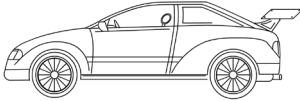

NUMER ZESTAWU
SET NUMBER
НОМЕР НАБОРА

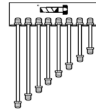

ROK PRODUKCJI
PRODUCTION YEAR
ГОД ВЫПУСКА АВТОМБИЯ



ODPOWIETRZNIK
BLEEDER SCREW
ШТУЦЕР ПРОКАЧКИ ТОРМОЗОВ

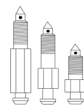

INDEKS
INDEX
ИНДЕКС



POŁOŻENIE
LOCATION
МЕСТО

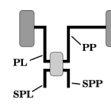

OPIS
DESCRIPTION
ОПИСАНИЕ

ZŁĄCZKA
FITTING
НАКОНЕЧНИК

ZŁĄCZKA
FITTING
НАКОНЕЧНИК

DŁUGOŚĆ
LENGTH
ДЛИНА

MARKA SAMOCHODU CAR MODEL МОДЕЛЬ АВТОМБИЯ	NUMER ZESTAWU SET NUMBER НОМЕР НАБОРА	ROK PRODUKCJI PRODUCTION YEAR ГОД ВЫПУСКА АВТОМБИЯ	ODPOWIETRZNIK BLEEDER SCREW ШТУЦЕР ПРОКАЧКИ ТОРМОЗОВ	INDEKS INDEX ИНДЕКС	POŁOŻENIE LOCATION МЕСТО	OPIS DESCRIPTION ОПИСАНИЕ
Renault R6						
R1181	ZWP-7306	74>80	0053P	WP-296	PL	109 109 0700
				WP-294	PP	109 109 1950
				WP-286	TL	109 109 0150
				WP-301	TP	109 109 1150
				WP-287	ZTL	109 109 0600
				WP-287	ZTP	109 109 0600
				WP-071	CL	109 114 3100
*02			0053T	WP-292	CP	109 109 3000
Renault R9						
	ZWP-7307		0053P	WP-117	PL	105 105 0750
				WP-010	PP	105 105 1850
			0069T	WP-115	TL	105 105 1150
			0053T	WP-009	TP	105 105 0600
				WP-021	CC	105 105 3600
Renault R12						
R1170	ZWP-7308	70>79	0053P	WP-065	PL	109 109 0800
				WP-079	PP	109 109 1400
				WP-296	TL	109 109 0700
				WP-057	TP	109 109 1100
				WP-311	CC	109 109 3600
*02			0053T	WP-306	CC+	109 114 3600
Renault R12						
R1170, R1171	ZWP-7309	70>79	0053P	WP-287	PL	109 109 0600
				WP-301	PP	109 109 1150
				WP-287	TL	109 109 0600
				WP-057	TP	109 109 1100
*01			0053T	WP-769	CC	109 109 3550
Renault R14						
Wszystkie modele All models Все модели	ZWP-7310	76>85	0086P	WP-028	PL	105 105 0550
			0053P	WP-022	PP	105 105 1350
				WP-028	TL	105 105 0550
				WP-117	TP	105 105 0750
				WP-009	ZTL	105 105 0600
*02				WP-009	ZTP	105 105 0600
*80			0053T	WP-310	CC	104 105 2800
Renault R16						
R1150	ZWP-7311	65>81	0053P	WP-287	PL	109 109 0600
				WP-079	PP	109 109 1400
				WP-296	TL	109 109 0700
				WP-293	TL+	109 109 0950
				WP-764	TP	109 109 0250
				WP-287	TP+	109 109 0600
			0053T	WP-768	CC	109 109 3400
Renault R18						
R1340, R1351	ZWP-7312	78>87	0069P	WP-117	PL	105 105 0750
			0053P	WP-115	PP	105 105 1150
				WP-035	TL	105 105 1100
				WP-018	TP	105 105 0650
*80			0053T	WP-046	CC	105 105 3500
Renault R18						
R1340, R1351	ZWP-7313	78>87	0069P	WP-300	PL	109 109 0750
			0053P	WP-301	PP	109 109 1150
				WP-057	TL	109 109 1100
				WP-296	TP	109 109 0700
*81			0053T	WP-769	CC	109 109 3550
Renault R19						
Wszystkie modele, bez ABS All models, without ABS Все модели, без ABS	ZWP-7314	89>12.95	0053P	WP-005	PL	105 105 0450
				WP-003	PP	105 105 1400
				WP-314	TL	104 105 1000
				WP-261	TP	104 105 0600
				WP-028	SPL	105 105 0550
				WP-102	SPP	105 106 0800
			0053T	WP-200	STL	105 106 1900
			0069T	WP-011	STP	105 105 2300
Renault R20						
Wszystkie modele All models Все модели	ZWP-7315	76>85	0053P	WP-013	PL	105 105 0900
				WP-003	PP	105 105 1400
				WP-045	TL	105 105 0400
				WP-028	TP	105 105 0550
				WP-009	ZTL	105 105 0600
				WP-009	ZTP	105 105 0600
				WP-313	CC	104 105 4900
*02			0053T	WP-312	CC+	104 105 5000

MARKA SAMOCHODU
CAR MODEL
МОДЕЛЬ АВТОМБИЯ

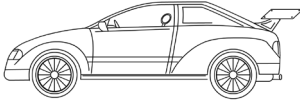

NUMER ZESTAWU
SET NUMBER
НОМЕР НАБОРА

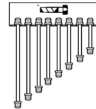

ROK PRODUKCJI
PRODUCTION YEAR
ГОД ВЫПУСКА АВТОМБИЯ



ODPOWIETRZNIK
BLEEDER SCREW
ШТУЦЕР ПРОКАЧКИ ТОРМОЗОВ

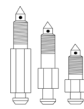

INDEKS
INDEX
ИНДЕКС



POŁOŻENIE
LOCATION
МЕСТО

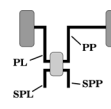

OPIS
DESCRIPTION
ОПИСАНИЕ

ZŁĄCZKA ZŁĄCZKA DŁUGOŚĆ
FITTING FITTING LENGTH
НАКОНЕЧНИК НАКОНЕЧНИК ДЛИНА

MARKA SAMOCHODU CAR MODEL МОДЕЛЬ АВТОМБИЯ	NUMER ZESTAWU SET NUMBER НОМЕР НАБОРА	ROK PRODUKCJI PRODUCTION YEAR ГОД ВЫПУСКА АВТОМБИЯ	ODPOWIETRZNIK BLEEDER SCREW ШТУЦЕР ПРОКАЧКИ ТОРМОЗОВ	INDEKS INDEX ИНДЕКС	POŁOŻENIE LOCATION МЕСТО	OPIS DESCRIPTION ОПИСАНИЕ				
Renault R30										
Wszystkie modele All models Все модели	ZWP-7316	75>85	0069P	WP-314	PL	104 105 1000				
				WP-019	PL+	105 105 1000				
				WP-049	PP	105 105 1900				
				WP-315	PP+	104 105 1950				
				WP-045	TL	105 105 0400				
				WP-028	TP	105 105 0550				
				WP-009	ZTL	105 105 0600				
				WP-009	ZTP	105 105 0600				
				WP-596	CC	104 105 5350				
				*02			0053T			
Renault Clio										
Wszystkie modele, bez ABS All models, without ABS Все модели, без ABS	ZWP-7317	06.90>08.98	0053P	WP-009	PL	105 105 0600				
				WP-035	PP	105 105 1100				
				WP-260	TL	104 105 0850				
				WP-261	TP	104 105 0600				
				WP-199	SPL	105 106 0900				
				WP-117	SPP	105 105 0750				
				WP-008	STL	105 105 3000				
				WP-526	STP	105 106 2750				
							0069T			
							0053T			
Renault Clio II										
Wszystkie modele All models Все модели	ZWP-7322	09.98>		WP-314	PL	104 105 1000				
				WP-005	PP	105 105 0450				
				WP-489	SPL	104 105 1100				
				WP-115	SPP	105 105 1150				
				WP-023	STL	105 105 1800				
				WP-023	STP	105 105 1800				
				WP-028	TL	105 105 0550				
				WP-196	TP	105 105 1300				
				Renault Laguna						
				Sedan z ABS with ABS c ABS	ZWP-7318	95>02.01		WP-501	PL	104 105 0900
WP-049	PP	105 105 1900								
WP-024	TL	105 105 0800								
WP-018	TP	105 105 0650								
WP-435	SPL	105 105 1600								
WP-521	SPP	104 106 1200								
WP-526	STL	105 106 2750								
WP-015	STP	105 105 2700								
			0086T							
			0069T							
			0039T							
Renault Megane										
Coupe, Sedan z ABS with ABS c ABS	ZWP-7319	96>10.02		WP-484	PL	104 105 2000				
				WP-024	PP	105 105 0800				
				WP-024	TL	105 105 0800				
				WP-033	TP	105 105 0700				
				WP-513	SPL	104 105 2250				
				WP-390	SPP	105 105 2250				
				WP-503	STL	104 106 3300				
				WP-191	STP	105 106 3100				
							0069T			
			0053T							
Renault Scenic										
Wszystkie modele All models Все модели	ZWP-7323	01.97>06.03		WP-266	PL	104 105 1900				
				WP-480	PP	104 105 1500				
				WP-494	SPL	105 105 1600				
				WP-488	SPP	105 105 1700				
				WP-093	STL	105 106 3000				
				WP-093	STP	105 106 3000				
				WP-024	TL	105 105 0800				
				WP-018	TP	105 105 0650				
				Renault Trafic						
Wszystkie modele, z ABS All models, with ABS Все модели, с ABS	ZWP-7324	03.01>		WP-484	PL	104 105 2000				
				WP-014	PP	105 105 2400				
				WP-398	CL	104 105 2100				
				WP-016	CP	105 105 2900				
				WP-028	TL	105 105 0550				
				WP-028	TP	105 105 0550				
Renault Trafic										
T 800 rozstaw osi 2780 mm wheel base 2780 mm колесная база 2780 мм	ZWP-7320	82>90	0053P	WP-196	PL	105 105 1300				
				WP-404	PP	105 105 2550				
				WP-024	TL	105 105 0800				
				WP-036	TP	105 105 2100				
				WP-046	CC	105 105 3500				
			0053T							
			0039T							
Renault Twingo										
Wszystkie modele, bez ABS All models, without ABS Все модели, без ABS	ZWP-7321	03.93>	0069P	WP-017	PL	105 105 0500				
				WP-049	PP	105 105 1900				
				WP-499	TL	104 105 0650				
				WP-486	TP	104 105 1850				
				WP-008	CL	105 105 3000				
				WP-008	CP	105 105 3000				
			0053P							
			0053T							

MARKA SAMOCHODU
CAR MODEL
МОДЕЛЬ АВТОМБИЯ

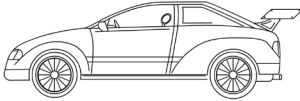

NUMER ZESTAWU
SET NUMBER
НОМЕР НАБОРА

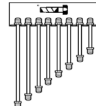

ROK PRODUKCJI
PRODUCTION YEAR
ГОД ВЫПУСКА АВТОМБИЯ



ODPOWIETRZNIK
BLEEDER SCREW
ШТУЦЕР ПРОКАЧКИ ТОРМОЗОВ

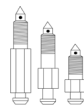

INDEKS
INDEX
ИНДЕКС



POŁOŻENIE
LOCATION
МЕСТО

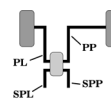

OPIS
DESCRIPTION
ОПИСАНИЕ

ZŁĄCZKA ZŁĄCZKA DŁUGOŚĆ
FITTING FITTING LENGTH
НАКОНЕЧНИК НАКОНЕЧНИК ДЛИНА

MARKA SAMOCHODU CAR MODEL МОДЕЛЬ АВТОМБИЯ	NUMER ZESTAWU SET NUMBER НОМЕР НАБОРА	ROK PRODUKCJI PRODUCTION YEAR ГОД ВЫПУСКА АВТОМБИЯ	ODPOWIETRZNIK BLEEDER SCREW ШТУЦЕР ПРОКАЧКИ ТОРМОЗОВ	INDEKS INDEX ИНДЕКС	POŁOŻENIE LOCATION МЕСТО	OPIS DESCRIPTION ОПИСАНИЕ
Rover Allegro						
Wszystkie modele All models Все модели *02 *80	ZWP-7401	75>03.82	0108P	WP-088	ZPL	105 106 0150
				WP-088	ZPP	105 106 0150
				WP-089	PL	104 106 0950
				WP-090	PP	105 106 0650
				WP-385	TL	105 106 0450
				WP-385	TP	105 106 0450
				WP-093	CL	105 106 3000
				WP-092	CP	104 106 2700
				0108T		
Rover Allegro						
Wszystkie modele All models Все модели *02 *81	ZWP-7402	75>03.82	0108P	WP-726	ZPL	105 110 0150
				WP-726	ZPP	105 110 0150
				WP-783	PL	110 114 0950
				WP-059	PP	109 110 0650
				WP-085	TL	109 110 0450
				WP-085	TP	109 110 0450
				WP-775	CL	109 110 3050
				WP-784	CP	110 114 2700
				0108T		
Rover Leyland Sherpa 240						
Wszystkie modele All models Все модели	ZWP-7403	74>78	0107P	WP-041	ZPL	105 105 0350
				WP-041	ZPP	105 105 0350
				WP-186	PL	105 106 1150
				WP-715	PP	105 106 1800
				WP-019	TL	105 105 1000
				WP-024	TP	105 105 0800
				WP-088	ZTL	105 106 0150
				WP-088	ZTP	105 106 0150
				WP-116	CC	106 106 2400
				WP-032	CC+	105 105 2800
Rover Marina						
1.3 *01 *71	ZWP-7404	04.71>07.81	0108P 0049P	WP-064	ZPL	109 110 0200
				WP-402	ZPP	109 109 0400
				WP-077	PL	109 110 1750
				WP-097	PP	109 110 0850
				WP-305	TL	109 109 1450
				WP-073	TP	109 110 0550
				WP-776	CC	109 110 3250
				0049T 0108T		
Rover Marina						
1.3, 1.8 *01 *69 *72	ZWP-7405	04.71>10.75	0108P 0049P	WP-064	ZPL	109 110 0200
				WP-064	ZPP	109 110 0200
				WP-077	PL	109 110 1750
				WP-086	PP	109 110 0750
				WP-305	TL	109 109 1450
				WP-073	TP	109 110 0550
				WP-776	CC	109 110 3250
				0049T 0108T		
Rover Marina						
1.3, 1.8 *02 *69 *72	ZWP-7406	72>07.81	0108P 0049P	WP-060	ZPL	109 110 0150
				WP-060	ZPP	109 110 0150
				WP-081	PL	110 114 1400
				WP-082	PP	110 114 0850
				WP-305	TL	109 109 1450
				WP-073	TP	109 110 0550
				WP-083	CC	109 110 3500
				0049T 0108T		
Rover Maxi						
Wszystkie modele All models Все модели *01	ZWP-7407	69>82	0108P	WP-064	ZPL	109 110 0200
				WP-064	ZPP	109 110 0200
				WP-078	PL	109 110 0800
				WP-770	PP	109 110 1250
				WP-095	TP	109 110 0600
				WP-086	ZTL	109 110 0750
				WP-086	ZTP	109 110 0750
				WP-183	SP	109 110 1150
				WP-096	ST	109 110 2300
				0108T		
Rover Maxi						
Wszystkie modele All models Все модели *02 *80	ZWP-7408	69>82	0108P	WP-101	ZPL	105 106 0200
				WP-101	ZPP	105 106 0200
				WP-102	PL	105 106 0800
				WP-103	PP	104 106 1400
				WP-090	TL	105 106 0650
				WP-090	TP	105 106 0650
				WP-104	SPL	105 106 1000
				WP-105	SPP	104 106 0750
				WP-106	STL	106 106 2300
				WP-763	STP	106 106 2250
				0108T		

MARKA SAMOCHODU
CAR MODEL
МОДЕЛЬ АВТОМБИЯ

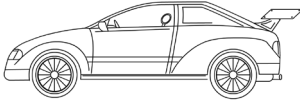

NUMER ZESTAWU
SET NUMBER
НОМЕР НАБОРА

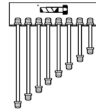

ROK PRODUKCJI
PRODUCTION YEAR
ГОД ВЫПУСКА АВТОМБИЯ



ODPOWIETRZNIK
BLEEDER SCREW
ШТУЦЕР ПРОКАЧКИ ТОРМОЗОВ

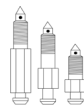

INDEKS
INDEX
ИНДЕКС



POŁOŻENIE
LOCATION
МЕСТО

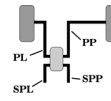

OPIS
DESCRIPTION
ОПИСАНИЕ

ZŁĄCZKA ZŁĄCZKA DŁUGOŚĆ
FITTING FITTING LENGTH
НАКОНЕЧНИК НАКОНЕЧНИК ДЛИНА

MARKA SAMOCHODU CAR MODEL МОДЕЛЬ АВТОМБИЯ	NUMER ZESTAWU SET NUMBER НОМЕР НАБОРА	ROK PRODUKCJI PRODUCTION YEAR ГОД ВЫПУСКА АВТОМБИЯ	ODPOWIETRZNIK BLEEDER SCREW ШТУЦЕР ПРОКАЧКИ ТОРМОЗОВ	INDEKS INDEX ИНДЕКС	POŁOŻENIE LOCATION МЕСТО	OPIS DESCRIPTION ОПИСАНИЕ
Rover Maxi						
Wszystkie modele All models Все модели bez naprzemianległego systemu hamulcowego without diagonal brake system без перекрёстной тормозной системы *02 *80	ZWP-7409	69>82	0108P	WP-064	ZPL	109 110 0200
				WP-064	ZPP	109 110 0200
				WP-078	PL	109 110 0800
				WP-097	PP	109 110 0850
				WP-059	TL	109 110 0650
				WP-059	TP	109 110 0650
				WP-059	TP+	109 110 0650
				WP-078	SP	109 110 0800
				WP-096	ST	109 110 2300
				0108T		
Rover Maxi						
Wszystkie modele All models Все модели z naprzemianległym systemem hamulcowym with diagonal brake system с перекрёстной тормозной системой *02 *81	ZWP-7410	69>82	0108P	WP-064	ZPL	109 110 0200
				WP-064	ZPP	109 110 0200
				WP-078	PL	109 110 0800
				WP-081	PP	110 114 1400
				WP-059	TL	109 110 0650
				WP-059	TP	109 110 0650
				WP-098	SPL	109 110 1000
				WP-099	SPP	110 114 0750
				WP-781	STL	110 110 2250
				WP-781	STP	110 110 2250
0108T						
Rover Mini						
Sedan bez hydragastic without hydragastic без hydragastic *01	ZWP-7411	>75	0107P	WP-764	ZPL	109 109 0250
				WP-764	ZPP	109 109 0250
				WP-057	PL	109 109 1100
				WP-058	PP	109 109 0450
				WP-059	TL	109 110 0650
				WP-060	TP	109 110 0150
				WP-061	ZTL	109 110 0300
				WP-061	ZTP	109 110 0300
				WP-766	CC	109 109 2550
				0105T		
Rover Mini						
*02	ZWP-7412	>77	0107P	WP-764	ZPL	109 109 0250
				WP-764	ZPP	109 109 0250
				WP-058	PL	109 109 0450
				WP-065	PL+	109 109 0800
				WP-066	PP	109 114 0450
				WP-061	TL	109 110 0300
				WP-061	TP	109 110 0300
				WP-785	CL	110 114 2950
				WP-772	CP	109 110 2450
				0105T		
Rover Mini						
*02	ZWP-7413	78>80	0107P	WP-764	ZPL	109 109 0250
				WP-764	ZPP	109 109 0250
				WP-407	PL	109 109 0500
				WP-407	PP	109 109 0500
				WP-061	TL	109 110 0300
				WP-061	TP	109 110 0300
				WP-170	CL	109 110 3200
				WP-170	CP	109 110 3200
				0105T		
				Rover Mini		
850 Sedan, 1000 Combi *02	ZWP-7414	12.77>80	0107P	WP-764	ZPL	109 109 0250
				WP-764	ZPP	109 109 0250
				WP-058	PL	109 109 0450
				WP-065	PL+	109 109 0800
				WP-066	PP	109 114 0450
				WP-780	TL	110 110 0200
				WP-780	TP	110 110 0200
				WP-061	ZTL	109 110 0300
				WP-061	ZTP	109 110 0300
				WP-767	CC	109 109 2650
WP-779	CC+	109 114 3150				
0105T						
Saab 96						
Wszystkie modele All models Все модели Nr 52000 *72	ZWP-7501	68>80	0108P	WP-085	PL	109 110 0450
				WP-084	PP	109 110 0900
				WP-095	TL	109 110 0600
				WP-076	TP	109 110 1350
				WP-178	ZTL	109 110 0350
				WP-178	ZTP	109 110 0350
				WP-329	CL	109 109 2200
				WP-297	CP	109 109 2100
0033T						
Saab 96						
Wszystkie modele All models Все модели Nr 52001 *72	ZWP-7502	68>80	0108P	WP-073	PL	109 110 0550
				WP-084	PP	109 110 0900
				WP-073	TL	109 110 0550
				WP-076	TP	109 110 1350
				WP-178	ZTL	109 110 0350
				WP-178	ZTP	109 110 0350
				WP-329	CL	109 109 2200
				WP-329	CP	109 109 2200
0033T						

MARKA SAMOCHODU
CAR MODEL
МОДЕЛЬ АВТОМБИЯ

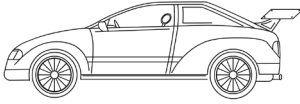

NUMER ZESTAWU
SET NUMBER
НОМЕР НАБОРА

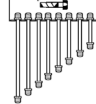

ROK PRODUKCJI
PRODUCTION YEAR
ГОД ВЫПУСКА АВТОМБИЯ



ODPOWIETRZNIK
BLEEDER SCREW
ШТУЦЕР ПРОКАЧКИ ТОРМОЗОВ

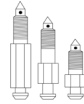

INDEKS
INDEX
ИНДЕКС



POŁOŻENIE
LOCATION
МЕСТО

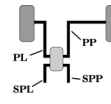

OPIS
DESCRIPTION
ОПИСАНИЕ

ZŁĄCZKA ZŁĄCZKA DŁUGOŚĆ
FITTING FITTING LENGTH
НАКОНЕЧНИК НАКОНЕЧНИК ДЛИНА

MARKA SAMOCHODU CAR MODEL МОДЕЛЬ АВТОМБИЯ	NUMER ZESTAWU SET NUMBER НОМЕР НАБОРА	ROK PRODUKCJI PRODUCTION YEAR ГОД ВЫПУСКА АВТОМБИЯ	ODPOWIETRZNIK BLEEDER SCREW ШТУЦЕР ПРОКАЧКИ ТОРМОЗОВ	INDEKS INDEX ИНДЕКС	POŁOŻENIE LOCATION МЕСТО	OPIS DESCRIPTION ОПИСАНИЕ
Saab 99						
Wszystkie modele All models Все модели	ZWP-7503	75>85	0086P	WP-088	ZPL	105 106 0150
				WP-088	ZPP	105 106 0150
				WP-024	PL	105 105 0800
				WP-039	PP	105 105 1550
				WP-109	TL	105 106 1100
				WP-108	TP	105 106 0400
				WP-191	CL	105 106 3100
				WP-328	CP	105 106 3200
Saab 900						
Wszystkie modele All models Все модели	ZWP-7504	78>80	0039P	WP-013	PL	105 105 0900
				WP-039	PP	105 105 1550
				WP-186	TL	105 106 1150
				WP-108	TP	105 106 0400
				WP-328	CL	105 106 3200
				WP-328	CP	105 106 3200
Saab 900						
Wszystkie modele, bez ABS, bez CD All models, without ABS, without CD Все модели, без ABS, без CD	ZWP-7505	81>86	0039P	WP-002	PL	105 105 0850
				WP-042	PP	105 105 1700
				WP-186	TL	105 106 1150
				WP-385	TP	105 106 0450
				WP-566	CL	105 106 3250
				WP-566	CP	105 106 3250
Saab 900						
Wszystkie modele, bez ABS, bez CD All models, without ABS, without CD Все модели, без ABS, без CD	ZWP-7506	87>89	0039P	WP-002	PL	105 105 0850
				WP-042	PP	105 105 1700
				WP-186	TL	105 106 1150
				WP-385	TP	105 106 0450
				WP-566	CL	105 106 3250
				WP-717	CP	105 106 2350
Saab 900						
Wszystkie modele, z ABS, bez CV All models, with ABS, without CV Все модели, с ABS, без CV	ZWP-7507	86>93	0039P	WP-013	PL	105 105 0900
				WP-042	PP	105 105 1700
				WP-019	TL	105 105 1000
				WP-005	TP	105 105 0450
				WP-566	SP	105 106 3250
				WP-091	ST	105 106 0250
Saab 900						
Wszystkie modele, z ABS All models, with ABS Все модели, с ABS	ZWP-7508	94>95	0087P	WP-309	PL	104 105 0700
				WP-010	PP	105 105 1850
				WP-018	TL	105 105 0650
				WP-018	TP	105 105 0650
				WP-597	SPL	104 106 1450
				WP-459	SPP	105 106 1500
				WP-560	STL	105 106 2050
				WP-563	STP	105 106 2500
				0087T		
Saab 900						
Wszystkie modele, z ABS All models, with ABS Все модели, с ABS	ZWP-7509	96>	0087P	WP-033	PL	105 105 0700
				WP-491	PP	104 105 1800
				WP-018	TL	105 105 0650
				WP-018	TP	105 105 0650
				WP-524	SPL	104 106 1300
				WP-198	SPP	105 106 1350
				WP-520	STL	105 106 1950
				WP-563	STP	105 106 2500
0087T						
Saab 9000						
Wszystkie modele, z ABS All models, with ABS Все модели, с ABS	ZWP-7510	85>89	0039P	WP-001	PL	105 105 0300
				WP-035	PP	105 105 1100
				WP-196	SPL	105 105 1300
				WP-034	SPP	105 105 1200
				WP-176	STL	105 106 3700
				WP-093	STP	105 106 3000
Saab 9000						
Wszystkie modele, bez ABS All models, without ABS Все модели, без ABS	ZWP-7511	90>91	0011P	WP-001	PL	105 105 0300
				WP-115	PP	105 105 1150
				WP-196	SPL	105 105 1300
				WP-034	SPP	105 105 1200
				WP-176	STL	105 106 3700
				WP-191	STP	105 106 3100
Saab 9000						
Wszystkie modele, bez ABS All models, without ABS Все модели, без ABS	ZWP-7512	92>	0011P	WP-001	PL	105 105 0300
				WP-115	PP	105 105 1150
				WP-003	SPL	105 105 1400
				WP-027	SPP	105 105 1250
				WP-176	STL	105 106 3700
				WP-093	STP	105 106 3000
0086T						

MARKA SAMOCHODU
CAR MODEL
МОДЕЛЬ АВТОМБИЯ

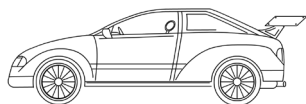

NUMER ZESTAWU
SET NUMBER
НОМЕР НАБОРА

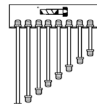

ROK PRODUKCJI
PRODUCTION YEAR
ГОД ВЫПУСКА АВТОМБИЯ



ODPOWIETRNIK
BLEEDER SCREW
ШТУЦЕР ПРОКАЧКИ ТОРМОЗОВ



INDEKS
INDEX
ИНДЕКС



POŁOŻENIE
LOCATION
МЕСТО

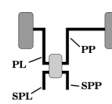

OPIS
DESCRIPTION
ОПИСАНИЕ

ZŁĄCZKA ZŁĄCZKA DŁUGOŚĆ
FITTING FITTING LENGTH
НАКОНЕЧНИК НАКОНЕЧНИК ДЛИНА

MARKA SAMOCHODU CAR MODEL МОДЕЛЬ АВТОМБИЯ	NUMER ZESTAWU SET NUMBER НОМЕР НАБОРА	ROK PRODUKCJI PRODUCTION YEAR ГОД ВЫПУСКА АВТОМБИЯ	ODPOWIETRNIK BLEEDER SCREW ШТУЦЕР ПРОКАЧКИ ТОРМОЗОВ	INDEKS INDEX ИНДЕКС	POŁOŻENIE LOCATION МЕСТО	OPIS DESCRIPTION ОПИСАНИЕ			
Saab 9000									
Wszystkie modele, z ABS All models, with ABS Все модели, с ABS Nr K1009731, K2004996, K8000276	ZWP-7513	85>89	0039P	WP-174	PL	105 106 0750			
				WP-386	PP	105 106 1050			
				WP-019	TL	105 105 1000			
				WP-045	TP	105 105 0400			
				WP-034	CL	105 105 1200			
				WP-529	CP	105 106 2800			
0088T									
0086T									
Saab 9000									
Wszystkie modele, z ABS All models, with ABS Все модели, с ABS Nr K1009732, K2004997, K8000277	ZWP-7514	89.	0039P	WP-110	PL	105 106 0550			
				WP-386	PP	105 106 1050			
				WP-019	TL	105 105 1000			
				WP-045	TP	105 105 0400			
				WP-027	CL	105 105 1250			
				WP-529	CP	105 106 2800			
0088T									
0086T									
Saab 9000									
Wszystkie modele, z ABS, MK.II All models, with ABS, MK.II Все модели, с ABS, MK.II	ZWP-7515	90>91	0011P	WP-110	PL	105 106 0550			
				WP-109	PP	105 106 1100			
				WP-019	TL	105 105 1000			
				WP-045	TP	105 105 0400			
				WP-027	SP	105 105 1250			
				WP-529	ST	105 106 2800			
0086T									
Saab 9000									
Wszystkie modele, z ABS, MK.II All models, with ABS, MK.II Все модели, с ABS, MK.II	ZWP-7516	92>95	0011P	WP-110	PL	105 106 0550			
				WP-386	PP	105 106 1050			
				WP-019	TL	105 105 1000			
				WP-045	TP	105 105 0400			
				WP-196	SP	105 105 1300			
				WP-526	ST	105 106 2750			
0086T									
Saab 9000									
Wszystkie modele, z ABS, MK.IV All models, with ABS, MK.IV Все модели, с ABS, MK.IV Nr T1022496	ZWP-7517	93>96	0011P	WP-018	PL	105 105 0650			
				WP-019	PP	105 105 1000			
				WP-115	SPL	105 105 1150			
				WP-115	SPP	105 105 1150			
				WP-176	STL	105 106 3700			
				WP-093	STP	105 106 3000			
0086T									
Saab 9000									
Wszystkie modele, z ABS, MK.IV All models, with ABS, MK.IV Все модели, с ABS, MK.IV Nr T1022497	ZWP-7517	96>98	0011P	WP-018	PL	105 105 0650			
				WP-019	PP	105 105 1000			
				WP-115	SPL	105 105 1150			
				WP-115	SPP	105 105 1150			
				WP-176	STL	105 106 3700			
				WP-093	STP	105 106 3000			
0086T									
Saab 9-3									
Wszystkie modele All models Все модели	ZWP-7519	98>	0011P	WP-033	PL	105 105 0700			
				WP-491	PP	104 105 1800			
				WP-009	TL	105 105 0600			
				WP-009	TP	105 105 0600			
				WP-495	SPL	104 106 1300			
				WP-520	SPP	105 106 1950			
				WP-198	STL	105 106 1350			
				WP-563	STP	105 106 2500			
				0086T					
				Saab 9-5					
Wszystkie modele All models Все модели	ZWP-7520	98>	0011P	WP-045	PL	105 105 0400			
				WP-486	PP	104 105 1850			
				WP-028	TL	105 105 0550			
				WP-028	TP	105 105 0550			
				WP-103	SPL	104 106 1400			
				WP-188	SPP	105 106 1250			
				WP-445	STL	105 106 2300			
				WP-404	STP	105 105 2550			
				0086T					
				Seat Alhambra					
Wszystkie modele All models Все модели Nr 7M-T-500001>7M-W020917	ZWP-7601	03.96>12.97	0086P	WP-037	PL	105 107 0800			
				WP-428	PP	105 105 2050			
				WP-024	TL	105 105 0800			
				WP-024	TP	105 105 0800			
				WP-042	SPL	105 105 1700			
				WP-197	SPP	105 106 1750			
				WP-023	STL	105 105 1800			
				WP-023	STP	105 105 1800			
				0033T					
				0019T					
Seat Alhambra									
Wszystkie modele All models Все модели Nr 7M-W-020918	ZWP-7602	07.97>	0086P	WP-309	PL	104 105 0700			
				WP-049	PP	105 105 1900			
				WP-024	TL	105 105 0800			
				WP-024	TP	105 105 0800			
				WP-433	SPL	105 105 2950			
				WP-093	SPP	105 106 3000			
				WP-197	STL	105 106 1750			
				WP-042	STP	105 105 1700			
				0033T					
				0019T					

MARKA SAMOCHODU
CAR MODEL
МОДЕЛЬ АВТОМБИЯ

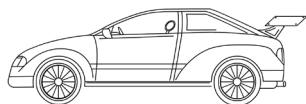

NUMER ZESTAWU
SET NUMBER
НОМЕР НАБОРА

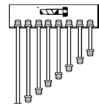

ROK PRODUKCJI
PRODUCTION YEAR
ГОД ВЫПУСКА АВТОМБИЯ



ODPOWIETRZNIK
BLEEDER SCREW
ШТУЦЕР ПРОКАЧКИ ТОРМОЗОВ



INDEKS
INDEX
ИНДЕКС



POŁOŻENIE
LOCATION
МЕСТО

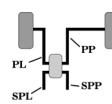

OPIS
DESCRIPTION
ОПИСАНИЕ

ZŁĄCZKA ZŁĄCZKA DŁUGOŚĆ
FITTING FITTING LENGTH
НАКОНЕЧНИК НАКОНЕЧНИК ДЛИНА

MARKA SAMOCHODU CAR MODEL МОДЕЛЬ АВТОМБИЯ	NUMER ZESTAWU SET NUMBER НОМЕР НАБОРА	ROK PRODUKCJI PRODUCTION YEAR ГОД ВЫПУСКА АВТОМБИЯ	ODPOWIETRZNIK BLEEDER SCREW ШТУЦЕР ПРОКАЧКИ ТОРМОЗОВ	INDEKS INDEX ИНДЕКС	POŁOŻENIE LOCATION МЕСТО	OPIS DESCRIPTION ОПИСАНИЕ
Seat Altea						
Wszystkie modele All models Все модели	ZWP-7619	03.04>		WP-497	PL	104 105 1450
				WP-005	PP	105 105 0450
				WP-1726	CL	104 105 3800
				WP-1872	CP	105 110X 3600
				WP-022	TP	105 105 1350
				WP-487	ZPL	104 105 0200
				WP-487	ZPP	104 105 0200
Seat Cordoba						
Wszystkie modele, bez ABS All models, without ABS Все модели, без ABS Nr 6K-TR069488>6K-X399999 *66 *73	ZWP-7603	01.93>06.99	0086P 0033T 0019T	WP-028 WP-003 WP-017 WP-018 WP-707 WP-007	PL PP TL TP CL CP	105 105 0550 105 105 1400 105 105 0500 105 105 0650 105 105 2650 105 105 3900
Seat Cordoba						
Wszystkie modele, bez ABS All models, without ABS Все модели, без ABS Nr 6K-TR069487 *66 *74	ZWP-7604	01.93>06.99	0086P 0033T 0019T	WP-028 WP-003 WP-017 WP-018 WP-015 WP-533	PL PP TL TP CL CP	105 105 0550 105 105 1400 105 105 0500 105 105 0650 105 105 2700 105 105 2750
Seat Cordoba						
Wszystkie modele, z ABS All models, with ABS Все модели, с ABS Nr 6K-TR069488>6K-X399999 *66	ZWP-7605	10.95>06.99	0086P 0013T 0019T	WP-028 WP-022 WP-017 WP-018 WP-533 WP-032	PL PP TL TP CL CP	105 105 0550 105 105 1350 105 105 0500 105 105 0650 105 105 2750 105 105 2800
Seat Cordoba						
Wszystkie modele, z ABS All models, with ABS Все модели, с ABS Nr 6K-TR069488>6K-X399999 *67	ZWP-7606	10.95>06.99	0086P 0013T 0019T	WP-028 WP-022 WP-005 WP-028 WP-533 WP-032	PL PP TL TP CL CP	105 105 0550 105 105 1350 105 105 0450 105 105 0550 105 105 2750 105 105 2800
Seat Cordoba						
Wszystkie modele, z ABS All models, with ABS Все модели, с ABS Nr 6K-X-400 000 - 6K-X-499 999 *66	ZWP-7607	07.99>09.02		WP-041 WP-035 WP-017 WP-009 WP-015 WP-533	PL PP TL TP CL CP	105 105 0350 105 105 1100 105 105 0500 105 105 0600 105 105 2700 105 105 2750
Seat Cordoba						
Wszystkie modele, z ABS All models, with ABS Все модели, с ABS Nr 6K-X-400 000 - 6K-X-499 999 *67	ZWP-7620	07.99>09.02		WP-041 WP-035 WP-015 WP-533	PL PP TL TP CL CP	105 105 0350 105 105 1100 N/A N/A 105 105 2700 105 105 2750
Seat Ibiza						
Wszystkie modele, bez ABS All models, without ABS Все модели, без ABS Nr 6K-TR069488>6K-X399999 *66 *73	ZWP-7603	01.93>06.99	0086P 0033T 0019T	WP-028 WP-003 WP-017 WP-018 WP-707 WP-007	PL PP TL TP CL CP	105 105 0550 105 105 1400 105 105 0500 105 105 0650 105 105 2650 105 105 3900
Seat Ibiza						
Wszystkie modele, bez ABS All models, without ABS Все модели, без ABS Nr 6K-TR069487 *68 *74	ZWP-7604	01.93>06.99	0086P 0033T 0019T	WP-028 WP-003 WP-017 WP-018 WP-015 WP-533	PL PP TL TP CL CP	105 105 0550 105 105 1400 105 105 0500 105 105 0650 105 105 2700 105 105 2750
Seat Ibiza						
Wszystkie modele, z ABS All models, with ABS Все модели, с ABS Nr 6K-TR069488>6K-X399999 *66	ZWP-7605	10.95>06.99	0086P 0013T 0019T	WP-028 WP-022 WP-017 WP-018 WP-533 WP-032	PL PP TL TP CL CP	105 105 0550 105 105 1350 105 105 0500 105 105 0650 105 105 2750 105 105 2800
Seat Ibiza						
Wszystkie modele, z ABS All models, with ABS Все модели, с ABS Nr 6K-TR069488>6K-X399999 *67	ZWP-7611	10.95>06.99	0086P 0013T 0019T	WP-028 WP-022 WP-005 WP-028 WP-533 WP-032	PL PP TL TP CL CP	105 105 0550 105 105 1350 105 105 0450 105 105 0550 105 105 2750 105 105 2800

MARKA SAMOCHODU
CAR MODEL
МОДЕЛЬ АВТОМБИЯ

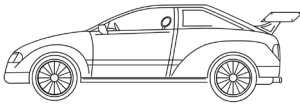

NUMER ZESTAWU
SET NUMBER
НОМЕР НАБОРА

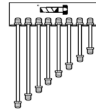

ROK PRODUKCJI
PRODUCTION YEAR
ГОД ВЫПУСКА АВТОМБИЯ



ODPOWIETRNIK
BLEEDER SCREW
ШТУЦЕР ПРОКАЧКИ ТОРМОЗОВ

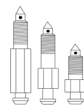

INDEKS
INDEX
ИНДЕКС



POŁOŻENIE
LOCATION
МЕСТО

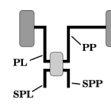

OPIS
DESCRIPTION
ОПИСАНИЕ

ZŁĄCZKA ZŁĄCZKA DŁUGOŚĆ
FITTING FITTING LENGTH
НАКОНЕЧНИК НАКОНЕЧНИК ДЛИНА

MARKA SAMOCHODU CAR MODEL МОДЕЛЬ АВТОМБИЯ	NUMER ZESTAWU SET NUMBER НОМЕР НАБОРА	ROK PRODUKCJI PRODUCTION YEAR ГОД ВЫПУСКА АВТОМБИЯ	ODPOWIETRNIK BLEEDER SCREW ШТУЦЕР ПРОКАЧКИ ТОРМОЗОВ	INDEKS INDEX ИНДЕКС	POŁOŻENIE LOCATION МЕСТО	OPIS DESCRIPTION ОПИСАНИЕ
Seat Ibiza						
Wszystkie modele, z ABS All models, with ABS Все модели, с ABS Nr 6K-X-400 000 - 6K-X-499 999 *66	ZWP-7607	07.99>09.02		WP-041	PL	105 105 0350
				WP-035	PP	105 105 1100
				WP-017	TL	105 105 0500
				WP-009	TP	105 105 0600
				WP-015	CL	105 105 2700
WP-533	CP	105 105 2750				
Seat Ibiza						
Wszystkie modele, z ABS All models, with ABS Все модели, с ABS Nr 6K-X-400 000 - 6K-X-499 999 *67	ZWP-7620	07.99>09.02		WP-041	PL	105 105 0350
				WP-035	PP	105 105 1100
					TL	N/A
					TP	N/A
				WP-015	CL	105 105 2700
WP-533	CP	105 105 2750				
Seat Vario						
Wszystkie modele, bez ABS All models, without ABS Все модели, без ABS Nr 6K-TR069487 *66 *74	ZWP-7604	01.93>06.99	0086P	WP-028	PL	105 105 0550
				WP-003	PP	105 105 1400
				WP-017	TL	105 105 0500
				WP-018	TP	105 105 0650
				WP-015	CL	105 105 2700
WP-533	CP	105 105 2750				
0019T						
Seat Vario						
Wszystkie modele, bez ABS All models, without ABS Все модели, без ABS Nr 6K-TR069488>6K-X399999 *66 *73	ZWP-7603	01.93>06.99	0086P	WP-028	PL	105 105 0550
				WP-003	PP	105 105 1400
				WP-017	TL	105 105 0500
				WP-018	TP	105 105 0650
				WP-707	CL	105 105 2650
WP-007	CP	105 105 3900				
0019T						
Seat Vario						
Wszystkie modele, z ABS All models, with ABS Все модели, с ABS Nr 6K-TR069488>6K-X399999 *66	ZWP-7605	10.95>06.99	0086P	WP-028	PL	105 105 0550
				WP-022	PP	105 105 1350
				WP-017	TL	105 105 0500
				WP-018	TP	105 105 0650
				WP-533	CL	105 105 2750
WP-032	CP	105 105 2800				
0019T						
Seat Vario						
Wszystkie modele, z ABS All models, with ABS Все модели, с ABS Nr 6K-TR069488>6K-X399999 *67	ZWP-7611	10.95>06.99	0086P	WP-028	PL	105 105 0550
				WP-022	PP	105 105 1350
				WP-005	TL	105 105 0450
				WP-028	TP	105 105 0550
				WP-533	CL	105 105 2750
WP-032	CP	105 105 2800				
0019T						
Seat Toledo						
Wszystkie modele, bez ABS All models, without ABS Все модели, без ABS *02 *69	ZWP-7616	07.91>09.98	0086P	WP-018	PL	105 105 0650
				WP-022	PP	105 105 1350
				WP-024	TL	105 105 0800
				WP-013	TP	105 105 0900
				WP-014	CL	105 105 2400
WP-048	CP	105 105 2500				
0033T 0013T 0019T						
Seat Toledo II						
Wszystkie modele, z ABS - ESP All models, with ABS - ESP Все модели, с ABS - ESP *013T	ZWP-7617	04.99>	0015P	WP-499	PL	104 105 0650
				WP-497	PP	105 105 1450
				WP-1725	CL	104 105 2550
				WP-030	CP	105 105 3700
					TL	N/A
	TP	N/A				
0013T						
Seat Toledo II						
Wszystkie modele, z ABS + ESP All models, with ABS + ESP Все модели, с ABS + ESP *013T	ZWP-7618	04.99>	0015P	WP-499	PL	104 105 0650
				WP-356	PP	105 105 1450
				WP-1725	CL	104 105 2550
				WP-1723	CP	104 104 2650
					TL	N/A
	TP	N/A				
0013T						
Skoda						
100, 110, 110R, 100LS *02 *69	ZWP-7701	96>77	0011P	WP-041	ZPL	105 105 0350
				WP-041	ZPP	105 105 0350
				WP-024	PL	105 105 0800
				WP-028	PP	105 105 0550
				WP-117	TL	105 105 0750
WP-001	TP	105 105 0300				
WP-015	CC	105 105 2700				
0011T						
Skoda						
105L, 105S, 120L, 130 *71	ZWP-7702	04.77>06.80	0011P	WP-001	ZPL	105 105 0300
				WP-041	ZPP	105 105 0350
				WP-117	PL	105 105 0750
				WP-117	PP	105 105 0750
				WP-252	TL	105 105 1050
WP-196	TP	105 105 1300				
WP-049	CC	105 105 1900				
0011T						

MARKA SAMOCHODU
CAR MODEL
МОДЕЛЬ АВТОМБИЯ

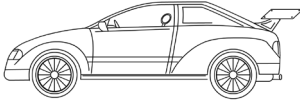

NUMER ZESTAWU
SET NUMBER
НОМЕР НАБОРА

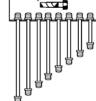

ROK PRODUKCJI
PRODUCTION YEAR
ГОД ВЫПУСКА АВТОМБИЯ



ODPOWIETRZNIK
BLEEDER SCREW
ШТУЦЕР ПРОКАЧКИ ТОРМОЗОВ

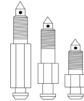

INDEKS
INDEX
ИНДЕКС



POŁOŻENIE
LOCATION
МЕСТО

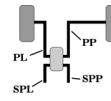

OPIS
DESCRIPTION
ОПИСАНИЕ

ZŁĄCZKA
FITTING
НАКОНЕЧНИК

ZŁĄCZKA
FITTING
НАКОНЕЧНИК

DŁUGOŚĆ
LENGTH
ДЛИНА

MARKA SAMOCHODU CAR MODEL МОДЕЛЬ АВТОМБИЯ	NUMER ZESTAWU SET NUMBER НОМЕР НАБОРА	ROK PRODUKCJI PRODUCTION YEAR ГОД ВЫПУСКА АВТОМБИЯ	ODPOWIETRZNIK BLEEDER SCREW ШТУЦЕР ПРОКАЧКИ ТОРМОЗОВ	INDEKS INDEX ИНДЕКС	POŁOŻENIE LOCATION МЕСТО	OPIS DESCRIPTION ОПИСАНИЕ
Skoda						
105L, 105S, 120L, 130, Rapid	ZWP-7703	07.80>91	0011P	WP-001	ZPL	105 105 0300
				WP-001	ZPP	105 105 0300
				WP-117	PL	105 105 0750
				WP-117	PP	105 105 0750
				WP-041	SPL	105 105 0350
				WP-041	SPP	105 105 0350
				WP-009	POM-TRÓJ	105 105 0600
				WP-252	TL	105 105 1050
				WP-027	TP	105 105 1250
				WP-428	CC	105 105 2050
*72			0011T			
Skoda						
120LS, 120S	ZWP-7703	77>91	0011P	WP-001	ZPL	105 105 0300
				WP-001	ZPP	105 105 0300
				WP-117	PL	105 105 0750
				WP-117	PP	105 105 0750
				WP-041	SPL	105 105 0350
				WP-041	SPP	105 105 0350
				WP-009	POM-TRÓJ	105 105 0600
				WP-252	TL	105 105 1050
				WP-027	TP	105 105 1250
				WP-428	CC	105 105 2050
*72			0011T			
Skoda Fabia						
z ABS with ABS c ABS	ZWP-7705	12.99>		WP-253	CL	105 105 4200
				WP-209	CP	104 105 3000
				WP-497	PL	104 105 1450
				WP-013	PP	105 105 0900
				WP-549	POM-ABS	104 104 1000
				WP-541	POM-ABS	104 104 0900
				WP-018	ZTL	105 105 0650
				WP-018	ZTP	105 105 0650
Skoda Favorit						
Wszystkie modele All models Все модели	ZWP-7706	88>		WP-033	PL	105 105 0700
				WP-003	PP	105 105 1400
				WP-117	TL	105 105 0750
				WP-117	TP	105 105 0750
				WP-008	CL	105 105 3000
				WP-004	CP	105 105 3100
*72			0053T			
Skoda Felicia						
Wszystkie modele, z ABS All models, with ABS Все модели, c ABS	ZWP-7707	03.95.		WP-018	PL	105 105 0650
				WP-027	PP	105 105 1250
				WP-033	TL	105 105 0700
				WP-117	TP	105 105 0750
				WP-433	CL	105 105 2950
WP-358	CP	105 105 4000				
*72			0013T			
Skoda Octavia						
z ABS with ABS c ABS	ZWP-7708	10.96>05.04		WP-018	PL	105 105 0650
				WP-196	PP	105 105 1300
				WP-024	TL	105 105 0800
				WP-002	TP	105 105 0850
				WP-586	CL	104 105 2750
				WP-030	CP	105 105 3700
*66			0015T			
Skoda Octavia						
z ABS with ABS c ABS	ZWP-7708	10.96>05.04		WP-018	PL	105 105 0650
				WP-196	PP	105 105 1300
				WP-024	TL	105 105 0800
				WP-002	TP	105 105 0850
				WP-586	CL	104 105 2750
				WP-030	CP	105 105 3700
*67			0015T			
Sunbeam/Talbot Avenger						
1300, 1600	ZWP-7801	73>76	0108P	WP-064	ZPL	109 110 0200
				WP-064	ZPP	109 110 0200
				WP-334	PL	110 114 1750
				WP-782	PP	110 114 0350
				WP-336	TL	109 109 1500
				WP-086	TP	109 110 0750
				WP-772	CC	109 110 2450
*02			0049T			
Sunbeam/Talbot Avenger						
1300, 1600	ZWP-7802	77>80	0108P	WP-064	ZPL	109 110 0200
				WP-064	ZPP	109 110 0200
				WP-337	PL	105 110 1650
				WP-338	PP	105 110 0250
				WP-336	TL	109 109 1500
				WP-084	TP	109 110 0900
				WP-339	CC	105 110 2500
*02			0049T			

MARKA SAMOCHODU
CAR MODEL
МОДЕЛЬ АВТОМБИЯ

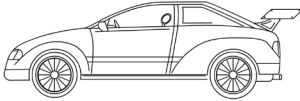

NUMER ZESTAWU
SET NUMBER
НОМЕР НАБОРА

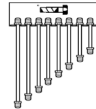

ROK PRODUKCJI
PRODUCTION YEAR
ГОД ВЫПУСКА АВТОМБИЯ



ODPOWIETRZNIK
BLEEDER SCREW
ШТУЦЕР ПРОКАЧКИ ТОРМОЗОВ

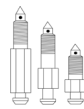

INDEKS
INDEX
ИНДЕКС



POŁOŻENIE
LOCATION
МЕСТО

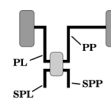

OPIS
DESCRIPTION
ОПИСАНИЕ

ZŁĄCZKA
FITTING
НАКОНЕЧНИК

ZŁĄCZKA
FITTING
НАКОНЕЧНИК

DŁUGOŚĆ
LENGTH
ДЛИНА

MARKA SAMOCHODU CAR MODEL МОДЕЛЬ АВТОМБИЯ	NUMER ZESTAWU SET NUMBER НОМЕР НАБОРА	ROK PRODUKCJI PRODUCTION YEAR ГОД ВЫПУСКА АВТОМБИЯ	ODPOWIETRZNIK BLEEDER SCREW ШТУЦЕР ПРОКАЧКИ ТОРМОЗОВ	INDEKS INDEX ИНДЕКС	POŁOŻENIE LOCATION МЕСТО	OPIS DESCRIPTION ОПИСАНИЕ
Suzuki Alto IV						
Wszystkie modele All models Все модели	ZWP-7902	07.02>		WP-140	PL	116 116 1500
				WP-120	PP	116 116 0550
				WP-1879	CL	116 116X 2650
				WP-818	CP	116 116 2550
				WP-810	TL	116 116 1250
				WP-431	TP	116 116 0650
Suzuki Marutti						
800 CAT.	ZWP-7904	>00		WP-138	PL	116 116 0350
				WP-429	PP	116 116 1000
				WP-146	CL	116 116 2100
				WP-146	CP	116 116 2100
				WP-1157	TL	116 116 0630
				WP-1157	TP	116 116 0630
				WP-130	ZTL	116 116 0250
				WP-130	ZTP	116 116 0250
				WP-070		116 116 0200
				WP-118		116 116 0300
Suzuki Swift III						
Wszystkie modele All models Все модели	ZWP-7903	02.05>		WP-812	PL	116 116 1750
				WP-431	PP	116 116 0650
				WP-1880	CL	116 116X 3250
				WP-863	CP	116 116X 3700
				WP-854	TL	116 116X 1000
				WP-1876	TP	116 116X 1200
Suzuki Samurai SJ413						
Wszystkie modele All models Все модели	ZWP-7905	81>98		WP-1294	PL	116 116 1120
				WP-141	PP	116 116 0600
				WP-222	CL	116 116 1650
				WP-1378	CP	116 116 1620
				WP-429	TL	116 116 1000
				WP-956	TP	116 116 0380
				WP-1294	POM-P	116 116 1120
				WP-1301	POM-L	116 116 1160
Suzuki Kombi-R						
Wszystkie modele, z ABS All models, with ABS Все модели, с ABS (SR410-2, SR412-2)	ZWP-7901	10.97>05.00	0017P	WP-857	PL	116 116X 1650
				WP-853	PP	116 116X 0550
				WP-810	TL	116 116 1250
				WP-125	TP	116 116 0750
				WP-130	ZTL	116 116 0250
				WP-130	ZTP	116 116 0250
				WP-861	CL	116 116X 2600
			0017T	WP-860	CP	116 116X 2500
Talbot 1100						
Wszystkie modele All models Все модели	ZWP-7803	69>76	0086P	WP-273	PL	115 115 0600
				WP-340	PP	115 115 0700
				WP-340	TL	115 115 0700
				WP-341	TP	115 115 0250
				WP-342	ZTL	115 115 0550
				WP-342	ZTP	115 115 0550
*01				WP-804	SP	115 115 2650
*69				WP-278	ST	115 115 0750
*72			0049T			
Talbot 1100						
Wszystkie modele All models Все модели	ZWP-7804	69>76	0086P	WP-340	PL	115 115 0700
				WP-282	PP	115 115 0450
				WP-340	TL	115 115 0700
				WP-341	TP	115 115 0250
				WP-273	ZTL	115 115 0600
				WP-273	ZTP	115 115 0600
*02				WP-344	SP	115 115 2200
*72			0049T	WP-278	ST	115 115 0750
Talbot 1100						
Wszystkie modele All models Все модели	ZWP-7805	77>81	0086P	WP-035	PL	105 105 1100
				WP-196	PP	105 105 1300
				WP-013	TL	105 105 0900
				WP-043	TP	105 105 0200
				WP-009	ZTL	105 105 0600
				WP-009	ZTP	105 105 0600
				WP-015	SP	105 105 2700
*72			0049T	WP-013	ST	105 105 0900
Talbot 1307-1309, 1508, 1609						
Wszystkie modele All models Все модели	ZWP-7806	75>83	0086P	WP-005	PL	105 105 0450
			0053P	WP-034	PP	105 105 1200
			0069P	WP-024	TL	105 105 0800
			0088P	WP-045	TP	105 105 0400
				WP-019	ZTL	105 105 1000
			0087T	WP-019	ZTP	105 105 1000
			0053T	WP-428	SP	105 105 2050
			0069T	WP-035	ST	105 105 1100

MARKA SAMOCHODU
CAR MODEL
МОДЕЛЬ АВТОМБИЯ

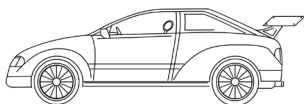

NUMER ZESTAWU
SET NUMBER
НОМЕР НАБОРА

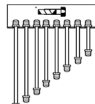

ROK PRODUKCJI
PRODUCTION YEAR
ГОД ВЫПУСКА АВТОМБИЯ



ODPOWIETRZNIK
BLEEDER SCREW
ШТУЦЕР ПРОКАЧКИ ТОРМОЗОВ



INDEKS
INDEX
ИНДЕКС



POŁOŻENIE
LOCATION
МЕСТО

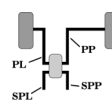

OPIS
DESCRIPTION
ОПИСАНИЕ

ZŁĄCZKA ZŁĄCZKA DŁUGOŚĆ
FITTING FITTING LENGTH
НАКОНЕЧНИК НАКОНЕЧНИК ДЛИНА

MARKA SAMOCHODU CAR MODEL МОДЕЛЬ АВТОМБИЯ	NUMER ZESTAWU SET NUMBER НОМЕР НАБОРА	ROK PRODUKCJI PRODUCTION YEAR ГОД ВЫПУСКА АВТОМБИЯ	ODPOWIETRZNIK BLEEDER SCREW ШТУЦЕР ПРОКАЧКИ ТОРМОЗОВ	INDEKS INDEX ИНДЕКС	POŁOŻENIE LOCATION МЕСТО	OPIS DESCRIPTION ОПИСАНИЕ
Talbot Horizon						
Wszystkie modele All models Все модели	ZWP-7807	78>86	0086P 0069P 0069T 0053T 0087T	WP-045 WP-196 WP-002 WP-041 WP-013 WP-013 WP-428 WP-252	PL PP TL TP ZTL ZTP SP ST	105 105 0400 105 105 1300 105 105 0850 105 105 0350 105 105 0900 105 105 0900 105 105 2050 105 105 1050
Talbot Samba						
Wszystkie modele All models Все модели	ZWP-7808	81>86	0086P 0053P 0053T	WP-033 WP-039 WP-028 WP-028 WP-014	PL PP TL TP CC	105 105 0700 105 105 1550 105 105 0550 105 105 0550 105 105 2400
Talbot Samba						
Wszystkie modele All models Все модели	ZWP-7806	75>83	0069P 0069T 0100T 0087T	WP-005 WP-034 WP-024 WP-045 WP-019 WP-019 WP-428 WP-035	PL PP TL TP ZTL ZTP SP ST	105 105 0450 105 105 1200 105 105 0800 105 105 0400 105 105 1000 105 105 1000 105 105 2050 105 105 1100
Tawria						
	ZWP-8001			WP-153 WP-154 WP-051 WP-051 WP-470 WP-469	PL PP TL TP CL CP	112 112 0650 112 112 0950 112 112 0550 112 112 0550 112 112 2850 112 112 2500
Tawria Lux						
	ZWP-8002			WP-159 WP-165 WP-051 WP-051 WP-157 WP-157	PL PP TL TP CL CP	112 112 0850 112 112 1400 112 112 0550 112 112 0550 112 112 3000 112 112 3000
Toyota Avensis						
*66	ZWP-81106	10.97>03.03	0086P	WP-028 WP-005 WP-752 WP-755 WP-001 WP-001	PL PP CL CP TL TP	105 105 0550 105 105 0450 105 116 3650 105 116 4450 105 105 0300 105 105 0300
Toyota Avensis						
1,8 95 kW 2,0 110 kW z ABS with ABS c ABS	ZWP-8101	10.00>	0086P	WP-025 WP-021 WP-265 WP-033 WP-001 WP-252 WP-009 WP-005 WP-001 WP-009	CP CL STL STP PL PP PL+ PP+ POM-ABS POM-ABS	105 105 4300 105 105 3600 105 105 0950 105 105 0700 105 105 0300 105 105 1050 105 105 0600 105 105 0450 105 105 0300 105 105 0600
Toyota Avensis						
Wagon 1,8 95 kW 2,0 110 kW z ABS with ABS c ABS	ZWP-8102	10.00>	0086P	WP-025 WP-021 WP-265 WP-033 WP-009 WP-005 WP-019 WP-041 WP-005 WP-028	CP CL SPL SPP PL PP PP POM-ABS POM-ABS POM-ABS	105 105 4300 105 105 3600 105 105 0950 105 105 0700 105 105 0600 105 105 0450 105 105 1000 105 105 0350 105 105 0250 105 105 0550
Toyota Avensis						
Wszystkie modele, bez D-4D, D-CAT All models, without D-4D, D-CAT Все модели, без D-4D, D-CAT	ZWP-81107	04.03>	0086P	WP-045 WP-034 WP-428 WP-428 WP-040 WP-040	PL PP SPL SPP CL CP	105 105 0400 105 105 1200 105 105 2050 105 105 2050 105 105 3300 105 105 3300
Toyota Avensis						
D-4D, D-CAT	ZWP-81108	04.03>	0086P	WP-045 WP-034 WP-1860 WP-1749 WP-040 WP-040	PL PP SPL SPP CL CP	105 105 0400 105 105 1200 105 105X 1950 105 105X 1900 105 105 3300 105 105 3300

MARKA SAMOCHODU
CAR MODEL
МОДЕЛЬ АВТОМБИЯ

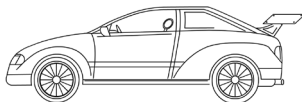

NUMER ZESTAWU
SET NUMBER
НОМЕР НАБОРА

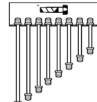

ROK PRODUKCJI
PRODUCTION YEAR
ГОД ВЫПУСКА АВТОМБИЯ



ODPOWIETRZNIK
BLEEDER SCREW
ШТУЦЕР ПРОКАЧКИ ТОРМОЗОВ



INDEKS
INDEX
ИНДЕКС



POŁOŻENIE
LOCATION
МЕСТО

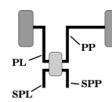

OPIS
DESCRIPTION
ОПИСАНИЕ

ZŁĄCZKA
FITTING
НАКОНЕЧНИК

ZŁĄCZKA
FITTING
НАКОНЕЧНИК

DŁUGOŚĆ
LENGTH
ДЛИНА

MARKA SAMOCHODU CAR MODEL МОДЕЛЬ АВТОМБИЯ	NUMER ZESTAWU SET NUMBER НОМЕР НАБОРА	ROK PRODUKCJI PRODUCTION YEAR ГОД ВЫПУСКА АВТОМБИЯ	ODPOWIETRZNIK BLEEDER SCREW ШТУЦЕР ПРОКАЧКИ ТОРМОЗОВ	INDEKS INDEX ИНДЕКС	POŁOŻENIE LOCATION МЕСТО	OPIS DESCRIPTION ОПИСАНИЕ
Toyota Camry						
CV1#, SV1#	ZWP-8103	10.82>05.84	0088P	WP-346	PL	105 116 0900
				WP-196	PP	105 105 1300
				WP-045	TL	105 105 0400
				WP-005	TP	105 105 0450
				WP-750	CL	105 116 3450
*75			0086T	WP-755	CP	105 116 4450
Toyota Camry						
CV1#, SV1#	ZWP-8104	06.84>09.86	0088P	WP-346	PL	105 116 0900
				WP-196	PP	105 105 1300
				WP-045	TL	105 105 0400
				WP-005	TP	105 105 0450
				WP-752	CL	105 116 3650
*75			0086T	WP-350	CP	105 116 4600
Toyota Camry						
SV2#, CV20 VZ21 bez ABS, Sedan VZ21 without ABS, Sedan VZ21 без ABS, Sedan	ZWP-8105	10.86>05.91	0069P	WP-346	PL	105 116 0900
				WP-003	PP	105 105 1400
				WP-001	TL	105 105 0300
				WP-001	TP	105 105 0300
				WP-750	CL	105 116 3450
			0086T	WP-756	CP	105 116 4550
Toyota Camry						
SXV10 bez ABS, Sedan SXV10 without ABS, Sedan SXV10 без ABS, Sedan	ZWP-8106	06.91>06.97	0086P	WP-018	PL	105 105 0650
				WP-461	PP	105 116 1100
				WP-578	ZTL	105 116 0300
				WP-578	ZTP	105 116 0300
				WP-864	CL	116 116X 4000
			0086T	WP-864	CP	116 116X 4000
Toyota Camry						
VCV10 bez ABS without ABS без ABS	ZWP-8107	06.91>06.97	0086P	WP-018	PL	105 105 0650
				WP-461	PP	105 116 1100
				WP-251	TL	116 116 1600
				WP-251	TP	116 116 1600
				WP-864	CL	116 116X 4000
			0086T	WP-864	CP	116 116X 4000
Toyota Camry						
SXV10 VCV10 z ABS, Sedan VCV10 with ABS, Sedan VCV10 c ABS, Sedan	ZWP-8108	06.91>06.97	0086P	WP-019	PL	105 105 1000
				WP-745	PP	105 116 2050
				WP-353	TL	105 116 0950
				WP-463	TP	105 116 1350
				WP-811	ZTL	116 116 1600
				WP-811	ZTP	116 116 1600
				WP-808	CL	116 116 0850
			0086T	WP-353	CP	105 116 0950
Toyota Camry						
SV2#, CV20 VZV21 bez ABS, Kombi VZV21 without ABS, Kombi VZV21 без ABS, Kombi	ZWP-8109	10.86>05.91	0069P	WP-346	PL	105 116 0900
				WP-003	PP	105 105 1400
				WP-840	TL	105 105X 1350
				WP-144	TP	116 116 0400
				WP-001	ZTL	105 105 0300
				WP-001	ZTP	105 105 0300
				WP-863	CL	116 116X 3700
			0086T	WP-863	CP	116 116X 3700
Toyota Carina II						
Wszystkie modele All models Все модели	ZWP-8110	10.83>11.87	0088P	WP-005	PL	105 105 0450
				WP-356	PP	105 105 1450
				WP-045	TL	105 105 0400
				WP-005	TP	105 105 0450
				WP-352	CL	105 116 3800
*75			0086T	WP-350	CP	105 116 4600
Toyota Carina II						
AT171, CT170, ST171, Sedan, Liftback bez ABS without ABS без ABS	ZWP-8111	12.87>01.92	0088P	WP-005	PL	105 105 0450
				WP-022	PP	105 105 1350
				WP-001	TL	105 105 0300
				WP-001	TP	105 105 0300
				WP-749	CL	105 116 3400
			0086T	WP-754	CP	105 116 4400
Toyota Carina II						
AT171, Sedan, Liftback z ABS with ABS c ABS	ZWP-8112	08.88>01.92	0088P	WP-579	PL	105 116 0400
				WP-461	PP	105 116 1100
				WP-001	ZTL	105 105 0300
				WP-001	ZTP	105 105 0300
				WP-749	CL	105 116 3400
			0086T	WP-754	CP	105 116 4400
Toyota Carina II						
ST171, Sedan, Liftback z ABS with ABS c ABS	ZWP-8113	11.88>01.92	0088P	WP-579	PL	105 116 0400
				WP-353	PP	105 116 0950
				WP-001	ZTL	105 105 0300
				WP-001	ZTP	105 105 0300
				WP-749	CL	105 116 3400
			0086T	WP-754	CP	105 116 4400

MARKA SAMOCHODU
CAR MODEL
МОДЕЛЬ АВТОМБИЯ

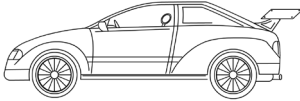

NUMER ZESTAWU
SET NUMBER
НОМЕР НАБОРА

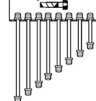

ROK PRODUKCJI
PRODUCTION YEAR
ГОД ВЫПУСКА АВТОМБИЯ



ODPOWIETRZNIK
BLEEDER SCREW
ШТУЦЕР ПРОКАЧКИ ТОРМОЗОВ

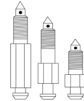

INDEKS
INDEX
ИНДЕКС



POŁOŻENIE
LOCATION
МЕСТО

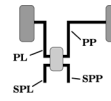

OPIS
DESCRIPTION
ОПИСАНИЕ

ZŁĄCZKA ZŁĄCZKA DŁUGOŚĆ
FITTING FITTING LENGTH
НАКОНЕЧНИК НАКОНЕЧНИК ДЛИНА

MARKA SAMOCHODU CAR MODEL МОДЕЛЬ АВТОМБИЯ	NUMER ZESTAWU SET NUMBER НОМЕР НАБОРА	ROK PRODUKCJI PRODUCTION YEAR ГОД ВЫПУСКА АВТОМБИЯ	ODPOWIETRZNIK BLEEDER SCREW ШТУЦЕР ПРОКАЧКИ ТОРМОЗОВ	INDEKS INDEX ИНДЕКС	POŁOŻENIE LOCATION МЕСТО	OPIS DESCRIPTION ОПИСАНИЕ
Toyota Carina II						
AT171, CT170, ST171, Kombi bez ABS without ABS без ABS	ZWP-8114	12.87>01.92	0088P	WP-005	PL	105 105 0450
				WP-463	PP	105 116 1350
				WP-741	TL	105 116 1050
				WP-351	TP	105 116 1450
				WP-001	ZTL	105 105 0300
				WP-001	ZTP	105 105 0300
				WP-122	CL	116 116 3700
				WP-567	CP	116 116 3550
Toyota Carina E						
AT19#, CT190, ST19#, Sedan, Japan z ABS with ABS с ABS	ZWP-8115	02.92>12.93	0086P	WP-847	PL	105 116X 0550
				WP-005	PP	105 105 0450
				WP-740	TL	105 116 1000
				WP-580	TP	105 116 1300
				WP-354	ZTL	105 116 0350
				WP-354	ZTP	105 116 0350
				WP-122	CL	116 116 3700
				WP-122	CP	116 116 3700
Toyota Carina E						
AT19#, CT190, ST19#, Sedan, Japan bez ABS without ABS без ABS	ZWP-8116	02.92>12.93	0086P	WP-028	PL	105 105 0550
				WP-739	PP	105 116 0850
				WP-579	TL	105 116 0400
				WP-579	TP	105 116 0400
				WP-751	CL	105 116 3600
Toyota Carina E						
AT19#, CT190, ST19#, Sedan, England bez ABS without ABS без ABS	ZWP-8116	11.92>12.95	0086P	WP-028	PL	105 105 0550
				WP-739	PP	105 116 0850
				WP-579	TL	105 116 0400
				WP-579	TP	105 116 0400
				WP-751	CL	105 116 3600
Toyota Carina E						
AT19#, CT190, ST191, Sedan, England z ABS with ABS с ABS	ZWP-8118	01.96>09.97	0086P	WP-028	PL	105 105 0550
				WP-739	PP	105 116 0850
				WP-579	TL	105 116 0400
				WP-579	TP	105 116 0400
				WP-749	CL	105 116 3400
Toyota Carina E						
AT19#, CT190, ST191, Sedan, England z ABS with ABS с ABS	ZWP-8119	12.94>09.97	0086P	WP-134	PL	116 116 0500
				WP-134	PP	116 116 0500
				WP-579	TL	105 116 0400
				WP-461	TP	105 116 1100
				WP-122	CL	116 116 3700
				WP-122	CP	116 116 3700
Toyota Carina E						
AT19#, CT190, ST19#, Sedan, England z ABS with ABS с ABS	ZWP-8120	11.92>11.94	0086P	WP-847	PL	105 116X 0550
				WP-005	PP	105 105 0450
				WP-580	TL	105 116 1300
				WP-580	TP	105 116 1300
				WP-354	ZTL	105 116 0350
				WP-354	ZTP	105 116 0350
				WP-122	CL	116 116 3700
				WP-122	CP	116 116 3700
Toyota Carina E						
AT19#, CT190, ST19#, Combi, Japan bez ABS without ABS без ABS	ZWP-8115	11.92>12.93	0086P	WP-028	PL	105 105 0550
				WP-739	PP	105 116 0850
				WP-740	TL	105 116 1000
				WP-580	TP	105 116 1300
				WP-354	ZTL	105 116 0350
				WP-354	ZTP	105 116 0350
				WP-122	CL	116 116 3700
Toyota Carina E						
AT19#, CT190, ST19#, Combi, Japan z ABS with ABS с ABS	ZWP-8122	11.92>12.93	0086P	WP-847	PL	105 116X 0550
				WP-005	PP	105 105 0450
				WP-429	TL	116 116 1000
				WP-917	TP	116 116 1300
				WP-354	ZTL	105 116 0350
				WP-354	ZTP	105 116 0350
				WP-122	CL	116 116 3700
				WP-122	CP	116 116 3700

MARKA SAMOCHODU
CAR MODEL
МОДЕЛЬ АВТОМБИЯ

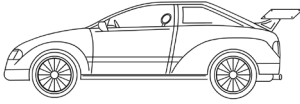

NUMER ZESTAWU
SET NUMBER
НОМЕР НАБОРА

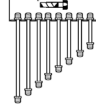

ROK PRODUKCJI
PRODUCTION YEAR
ГОД ВЫПУСКА АВТОМБИЯ



ODPOWIETRZNIK
BLEEDER SCREW
ШТУЦЕР ПРОКАЧКИ ТОРМОЗОВ

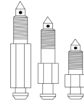

INDEKS
INDEX
ИНДЕКС



POŁOŻENIE
LOCATION
МЕСТО

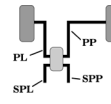

OPIS
DESCRIPTION
ОПИСАНИЕ

ZŁĄCZKA ZŁĄCZKA DŁUGOŚĆ
FITTING FITTING LENGTH
НАКОНЕЧНИК НАКОНЕЧНИК ДЛИНА

MARKA SAMOCHODU CAR MODEL МОДЕЛЬ АВТОМБИЯ	NUMER ZESTAWU SET NUMBER НОМЕР НАБОРА	ROK PRODUKCJI PRODUCTION YEAR ГОД ВЫПУСКА АВТОМБИЯ	ODPOWIETRZNIK BLEEDER SCREW ШТУЦЕР ПРОКАЧКИ ТОРМОЗОВ	INDEKS INDEX ИНДЕКС	POŁOŻENIE LOCATION МЕСТО	OPIS DESCRIPTION ОПИСАНИЕ
Toyota Carina E						
AT19#, CT190, ST19#, Combi, England z ABS with ABS c ABS	ZWP-8124	11.92>10.97	0086P	WP-028	PL	105 105 0550
				WP-005	PP	105 105 0450
				WP-580	TL	105 116 1300
				WP-355	TP	105 116 1150
				WP-354	ZTL	105 116 0350
				WP-354	ZTP	105 116 0350
				WP-122	CL	116 116 3700
			0086T	WP-122	CP	116 116 3700
Toyota Celica						
AT160	ZWP-8125	08.85>06.89	0088P	WP-017	PL	105 105 0500
				WP-463	PP	105 116 1350
				WP-041	TL	105 105 0350
				WP-041	TP	105 105 0350
				WP-752	CL	105 116 3650
			0086T	WP-757	CP	105 116 4750
*66						
Toyota Celica						
ST162	ZWP-8126	08.85>06.89	0088P	WP-017	PL	105 105 0500
			0069P	WP-463	PP	105 116 1350
			0086T	WP-752	CL	105 116 3650
			0069T	WP-757	CP	105 116 4750
*67						
Toyota Celica						
AT180, ST182 bez ABS without ABS без ABS	ZWP-8127	10.89>11.93	0088P	WP-017	PL	105 105 0500
			0069P	WP-463	PP	105 116 1350
				WP-041	TL	105 105 0350
				WP-041	TP	105 105 0350
			0069T	WP-749	CL	105 116 3400
			0086T	WP-570	CP	116 116 4500
Toyota Celica						
AT180 z ABS with ABS c ABS	ZWP-8128	08.90>11.93	0088P	WP-017	PL	105 105 0500
				WP-741	PP	105 116 1050
				WP-580	TL	105 116 1300
				WP-355	TP	105 116 1150
				WP-219	CL	116 116 4100
			0086T	WP-430	CP	116 116 4200
Toyota Celica						
ST182 z ABS with ABS c ABS	ZWP-8129	10.89>11.93	0069P	WP-017	PL	105 105 0500
				WP-346	PP	105 116 0900
				WP-580	TL	105 116 1300
				WP-355	TP	105 116 1150
				WP-219	CL	116 116 4100
			0086T	WP-430	CP	116 116 4200
Toyota Corolla						
KE70 Caravan	ZWP-8130	02.80>04.87	0086P	WP-028	PL	105 105 0550
				WP-005	PP	105 105 0450
				WP-035	TL	105 105 1100
				WP-005	TP	105 105 0450
			0086T	WP-015	CC	105 105 2700
Toyota Corolla						
KE70 Sedan	ZWP-8131	02.80>85	0086P	WP-028	PL	105 105 0550
				WP-005	PP	105 105 0450
				WP-035	TL	105 105 1100
				WP-117	TP	105 105 0750
			086T	WP-048	CC	105 105 2500
Toyota Corolla						
AE80, AE82, CE80, EE80	ZWP-8132	05.83>87	0088P	WP-009	PL	105 105 0600
				WP-353	PP	105 116 0950
				WP-005	TL	105 105 0450
				WP-005	TP	105 105 0450
				WP-752	CL	105 116 3650
			0086T	WP-755	CP	105 116 4450
*75						
Toyota Corolla						
AE86 GT	ZWP-8133	05.83>87	0086P	WP-047	PL	105 105 1500
				WP-041	PP	105 105 0350
				WP-035	TL	105 105 1100
				WP-018	TP	105 105 0650
			0086T	WP-014	CC	105 105 2400
Toyota Corolla						
AE92, CE90, EE90, Hatchback, Sedan, Liftback bez ABS without ABS без ABS	ZWP-8134	05.87>04.92	0088P	WP-005	PL	105 105 0450
				WP-353	PP	105 116 0950
				WP-041	ZTL	105 105 0350
				WP-041	ZTP	105 105 0350
				WP-347	CL	105 116 3500
			086T	WP-754	CP	105 116 4400

MARKA SAMOCHODU
CAR MODEL
МОДЕЛЬ АВТОМБИЯ

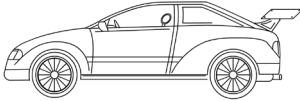

NUMER ZESTAWU
SET NUMBER
НОМЕР НАБОРА

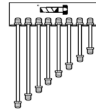

ROK PRODUKCJI
PRODUCTION YEAR
ГОД ВЫПУСКА АВТОМБИЯ



ODPOWIETRZNIK
BLEEDER SCREW
ШТУЦЕР ПРОКАЧКИ ТОРМОЗОВ

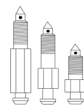

INDEKS
INDEX
ИНДЕКС



POŁOŻENIE
LOCATION
МЕСТО

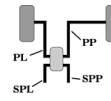

OPIS
DESCRIPTION
ОПИСАНИЕ

ZŁĄCZKA
FITTING
НАКОНЕЧНИК

ZŁĄCZKA
FITTING
НАКОНЕЧНИК

DŁUGOŚĆ
LENGTH
ДЛИНА

MARKA SAMOCHODU CAR MODEL МОДЕЛЬ АВТОМБИЯ	NUMER ZESTAWU SET NUMBER НОМЕР НАБОРА	ROK PRODUKCJI PRODUCTION YEAR ГОД ВЫПУСКА АВТОМБИЯ	ODPOWIETRZNIK BLEEDER SCREW ШТУЦЕР ПРОКАЧКИ ТОРМОЗОВ	INDEKS INDEX ИНДЕКС	POŁOŻENIE LOCATION МЕСТО	OPIS DESCRIPTION ОПИСАНИЕ
Toyota Corolla						
AE92, EE90, Kombi bez ABS without ABS без ABS	ZWP-8135	05.87>04.92	008P	WP-045	PL	105 105 0400
				WP-353	PP	105 116 0950
				WP-461	TL	105 116 1100
				WP-744	TP	105 116 1950
				WP-041	ZTL	105 105 0350
				WP-041	ZTP	105 105 0350
				WP-826	CL	116 116 3950
				WP-826	CP	116 116 3950
Toyota Corolla						
CE90, Kombi bez ABS without ABS без ABS	ZWP-8136	05.87>04.92	0088P	WP-045	PL	105 105 0400
				WP-353	PP	105 116 0950
				WP-461	TL	105 116 1100
				WP-744	TP	105 116 1950
				WP-041	ZTL	105 105 0350
				WP-041	ZTP	105 105 0350
				WP-347	CL	105 116 3500
				WP-754	CP	105 116 4400
Toyota Corolla						
AE92 z ABS with ABS с ABS	ZWP-8137	08.89>04.92	0088P	WP-045	PL	105 105 0400
				WP-353	PP	105 116 0950
				WP-751	CL	105 116 3600
				WP-755	CP	105 116 4450
Toyota Corolla						
AE95	ZWP-8138	05.87>04.92	0088P	WP-005	PL	105 105 0450
				WP-353	PP	105 116 0950
				WP-018	TL	105 105 0650
				WP-265	TP	105 105 0950
				WP-746	CL	105 116 2950
				WP-747	CP	105 116 3000
Toyota Corolla						
AE101, CE100, EE100, EE101, Hatchback, Sedan, Liftback bez ABS without ABS без ABS	ZWP-8139	05.92>11.96	0086P	WP-005	PL	105 105 0450
				WP-461	PP	105 116 1100
				WP-579	TL	105 116 0400
				WP-354	TP	105 116 0350
				WP-752	CL	105 116 3650
				WP-757	CP	105 116 4750
Toyota Corolla						
AE101, CE100, EE100#, Kombi bez ABS without ABS без ABS	ZWP-8140	05.92>04.95	0088P	WP-005	PL	105 105 0450
				WP-355	PP	105 116 1150
				WP-580	TL	105 116 1300
				WP-744	TP	105 116 1950
				WP-354	ZTL	105 116 0350
				WP-354	ZTP	105 116 0350
				WP-865	CL	116 116X 4200
				WP-868	CP	116 116X 4500
Toyota Corolla						
AE101, CE100, EE100#, Kombi bez ABS without ABS без ABS	ZWP-8141	05.95>11.96	0086P	WP-005	PL	105 105 0450
				WP-355	PP	105 116 1150
				WP-742	TL	105 116 1200
				WP-870	TP	105 116 1900
				WP-354	ZTL	105 116 0350
				WP-354	ZTP	105 116 0350
				WP-866	CL	116 116X 4400
				WP-867	CP	116 116X 4450
Toyota Corolla						
AE101, CE100, EE101, Hatchback, Sedan, Liftback, Kombi z ABS with ABS с ABS	ZWP-8142	05.92>04.95	0086P	WP-005	PL	105 105 0450
				WP-005	PP	105 105 0450
				WP-580	TL	105 116 1300
				WP-744	TP	105 116 1950
				WP-354	ZTL	105 116 0350
				WP-354	ZTP	105 116 0350
				WP-868	CL	116 116X 4500
				WP-865	CP	116 116X 4200
Toyota Corolla						
AE101, CE100, EE101, Hatchback, Sedan, Liftback, Kombi z ABS with ABS с ABS	ZWP-8143	05.95>11.96	0086P	WP-005	PL	105 105 0450
				WP-005	PP	105 105 0450
				WP-463	TL	105 116 1350
				WP-744	TP	105 116 1950
				WP-354	ZTL	105 116 0350
				WP-354	ZTP	105 116 0350
				WP-867	CL	116 116X 4450
				WP-866	CP	116 116X 4400
Toyota Corolla						
AE101, CE100, EE100, EE101, Hatchback, Sedan, Liftback bez ABS without ABS без ABS	ZWP-8144	12.96>03.97	0086P	WP-018	PL	105 105 0650
				WP-461	PP	105 116 1100
				WP-579	TL	105 116 0400
				WP-354	TP	105 116 0350
				WP-751	CL	105 116 3600
				WP-350	CP	105 116 4600

MARKA SAMOCHODU
CAR MODEL
МОДЕЛЬ АВТОМБИЯ

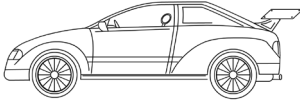

NUMER ZESTAWU
SET NUMBER
НОМЕР НАБОРА

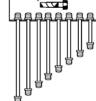

ROK PRODUKCJI
PRODUCTION YEAR
ГОД ВЫПУСКА АВТОМБИЯ



ODPOWIETRNIK
BLEEDER SCREW
ШТУЦЕР ПРОКАЧКИ ТОРМОЗОВ

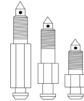

INDEKS
INDEX
ИНДЕКС



POŁOŻENIE
LOCATION
МЕСТО

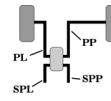

OPIS
DESCRIPTION
ОПИСАНИЕ

ZŁĄCZKA
FITTING
НАКОНЕЧНИК

ZŁĄCZKA
FITTING
НАКОНЕЧНИК

DŁUGOŚĆ
LENGTH
ДЛИНА

MARKA SAMOCHODU CAR MODEL МОДЕЛЬ АВТОМБИЯ	NUMER ZESTAWU SET NUMBER НОМЕР НАБОРА	ROK PRODUKCJI PRODUCTION YEAR ГОД ВЫПУСКА АВТОМБИЯ	ODPOWIETRNIK BLEEDER SCREW ШТУЦЕР ПРОКАЧКИ ТОРМОЗОВ	INDEKS INDEX ИНДЕКС	POŁOŻENIE LOCATION МЕСТО	OPIS DESCRIPTION ОПИСАНИЕ
Toyota Corolla						
AE101, CE100, EE10#, Kombi bez ABS without ABS без ABS	ZWP-8145	12.96>04.97	0086P	WP-005	PL	105 105 0450
				WP-355	PP	105 116 1150
				WP-742	TL	105 116 1200
				WP-870	TP	105 116 1900
				WP-354	ZTL	105 116 0350
				WP-354	ZTP	105 116 0350
				WP-866	CL	116 116X 4400
				WP-867	CP	116 116X 4450
Toyota Corolla						
AE101, CE100, EE101, Hatchback, Sedan, Kombi z ABS with ABS с ABS	ZWP-8146	12.96>03.97	0086P	WP-018	PL	105 105 0650
				WP-045	PP	105 105 0400
				WP-742	TL	105 116 1200
				WP-870	TP	105 116 1900
				WP-354	ZTL	105 116 0350
				WP-354	ZTP	105 116 0350
				WP-867	CL	116 116X 4450
				WP-866	CP	116 116X 4400
Toyota Corolla						
AE111, EE111, Japan	ZWP-8147	04.97>10.99		WP-018	PL	105 105 0650
				WP-041	PP	105 105 0350
				WP-354	TL	105 116 0350
				WP-354	TP	105 116 0350
				WP-755	CL	105 116 4550
Toyota Corolla						
ZZE111, ZZE112, Japan	ZWP-8147	11.99>11.01		WP-018	PL	105 105 0650
				WP-041	PP	105 105 0350
				WP-354	TL	105 116 0350
				WP-354	TP	105 116 0350
				WP-755	CL	105 116 4550
Toyota Corolla						
AE111, EE111, ZZE111, ZZE112, England	ZWP-8149	11.99>11.01		WP-018	PL	105 105 0650
				WP-041	PP	105 105 0350
				WP-041	TL	105 105 0350
				WP-041	TP	105 105 0350
				WP-257	CL	105 105 4500
Toyota Corolla						
AE111, EE111, ZZE111, ZZE112, Japan	ZWP-81109	04.97>12.01		WP-018	PL	105 105 0650
				WP-041	PP	105 105 0350
				WP-354	TL	105 116 0350
				WP-354	TP	105 116 0350
				WP-756	CL	105 116 4550
Toyota Corolla						
AE111, EE111, ZZE111, ZZE112, England	ZWP-8149	04.97>12.01		WP-018	PL	105 105 0650
				WP-041	PP	105 105 0350
				WP-257	CL	105 105 4500
				WP-021	CP	105 105 3600
				WP-041	TL	105 105 0350
Toyota Corolla Verso						
Wszystkie modele All models Все модели	ZWP-81111	01.02>03.04		WP-005	PL	105 105 0450
				WP-580	PP	105 116 1300
				WP-1733	CL	105 116 3350
				WP-352	CP	105 116 3800
Toyota Corolla Verso						
Wszystkie modele, bez Terra All models, without Terra Все модели, без Terra	ZWP-81112	04.04>		WP-045	PL	105 105 0400
				WP-027	PP	105 105 1250
				WP-1749	SPL	105 105X 1900
				WP-1746	SPP	105 105X 0950
				WP-004	CL	105 105 3100
Toyota Corolla Verso						
Terra	ZWP-81113	04.04>		WP-045	PL	105 105 0400
				WP-034	PP	105 105 1200
				WP-428	SPL	105 105 2050
				WP-036	SPP	105 105 2100
				WP-036	CL	105 105 3100
Toyota Corolla Verso						
				WP-020	CP	105 105 3400
				WP-020	CP	105 105 3400

MARKA SAMOCHODU
CAR MODEL
МОДЕЛЬ АВТОМБИЯ

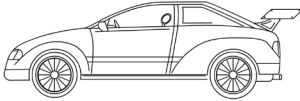

NUMER ZESTAWU
SET NUMBER
НОМЕР НАБОРА

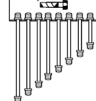

ROK PRODUKCJI
PRODUCTION YEAR
ГОД ВЫПУСКА АВТОМБИЯ



ODPOWIETRZNIK
BLEEDER SCREW
ШТУЦЕР ПРОКАЧКИ ТОРМОЗОВ

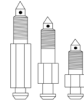

INDEKS
INDEX
ИНДЕКС



POŁOŻENIE
LOCATION
МЕСТО

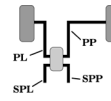

OPIS
DESCRIPTION
ОПИСАНИЕ

ZŁĄCZKA FITTING
ZŁĄCZKA FITTING
DŁUGOŚĆ LENGTH

MARKA SAMOCHODU CAR MODEL МОДЕЛЬ АВТОМБИЯ	NUMER ZESTAWU SET NUMBER НОМЕР НАБОРА	ROK PRODUKCJI PRODUCTION YEAR ГОД ВЫПУСКА АВТОМБИЯ	ODPOWIETRZNIK BLEEDER SCREW ШТУЦЕР ПРОКАЧКИ ТОРМОЗОВ	INDEKS INDEX ИНДЕКС	POŁOŻENIE LOCATION МЕСТО	OPIS DESCRIPTION ОПИСАНИЕ				
Toyota Dyna 100										
LH80, YH81	ZWP-8150	08.87>05.95	0017P	WP-735	ZPL	105 116 0250				
				WP-735	ZPP	105 116 0250				
				WP-001	PL	105 105 0300				
				WP-042	PP	105 105 1700				
				WP-558	TL	105 105X 0500				
				WP-837	TP	105 105X 1000				
				WP-042	SP	105 105 1700				
				WP-256	SP+	105 105 1750				
				WP-256	ST	105 105 1750				
				0019T	WP-023	ST+	105 105 1800			
Toyota Dyna 150										
LY61	ZWP-8151	08.87>05.95	0017P	WP-027	PL	105 105 1250				
				WP-115	PP	105 105 1150				
				WP-851	TL	116 116X 0450				
				WP-854	TP	116 116X 1000				
				WP-027	SP	105 105 1250				
				WP-356	SP+	105 105 1450				
				WP-049	ST	105 105 1900				
				0019T	WP-482	ST+	105 105 1950			
				Toyota Hiace LH						
				LH5#	ZWP-8152	12.82>07.85	0017P	WP-357	ZPL	105 116 0150
WP-357	ZPP	105 116 0150								
WP-027	PL	105 105 1250								
WP-428	PP	105 105 2050								
WP-027	TL	105 105 1250								
WP-005	TP	105 105 0450								
WP-440	SPL	105 105 2150								
WP-039	SPP	105 105 1550								
WP-440	STL	105 105 2150								
*75	0086T	WP-196	STP					105 105 1300		
Toyota Hiace LH										
LH6#	ZWP-8153	12.82>07.85	0017P	WP-357	ZPL	105 116 0150				
				WP-357	ZPP	105 116 0150				
				WP-027	PL	105 105 1250				
				WP-428	PP	105 105 2050				
				WP-027	TL	105 105 1250				
				WP-005	TP	105 105 0450				
				WP-440	SPL	105 105 2150				
				WP-039	SPP	105 105 1550				
				WP-390	STL	105 105 2250				
				*75	0019T	WP-047	STP	105 105 1500		
Toyota Hiace LH										
LH20	ZWP-8154	02.77>11.82	0017P	WP-024	PL	105 105 0800				
				WP-356	PP	105 105 1450				
				WP-034	TL	105 105 1200				
				WP-045	TP	105 105 0400				
				WP-356	CC	105 105 1450				
				0086T	WP-012	CC+	105 105 1650			
				Toyota Hiace LH						
LH30	ZWP-8155	02.77>11.82	0017P	WP-024	PL	105 105 0800				
				WP-356	PP	105 105 1450				
				WP-034	TL	105 105 1200				
				WP-045	TP	105 105 0400				
				WP-356	CC	105 105 1450				
				0086T	WP-012	CC+	105 105 1650			
				0086T	WP-049	CC++	105 105 1900			
Toyota Hiace LH										
LH51	ZWP-8156	08.85>08.89	0017P	WP-806	ZPL	116 116 0250				
				WP-806	ZPP	116 116 0250				
				WP-022	PL	105 105 1350				
				WP-036	PP	105 105 2100				
				WP-493	TL	105 105X 1250				
				WP-558	TP	105 105X 0500				
				WP-039	SPL	105 105 1550				
				WP-036	SPP	105 105 2100				
				WP-031	STL	105 105 2200				
				0019T	WP-022	STP	105 105 1350			
Toyota Hiace LH										
LH56	ZWP-8157	08.86>08.89	006T	WP-196	PL	105 105 1300				
				WP-841	PP	105 105X 1600				
				WP-493	TL	105 105X 1250				
				WP-558	TP	105 105X 0500				
				WP-042	SPL	105 105 1700				
				WP-036	SPP	105 105 2100				
				WP-031	STL	105 105 2200				
006T	WP-022	STP	105 105 1350							

MARKA SAMOCHODU
CAR MODEL
МОДЕЛЬ АВТОМБИЛЯ

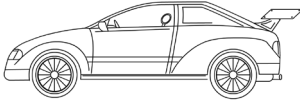

NUMER ZESTAWU
SET NUMBER
НОМЕР НАБОРА

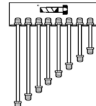

ROK PRODUKCJI
PRODUCTION YEAR
ГОД ВЫПУСКА АВТОМБИЛЯ



ODPOWIETRZNIK
BLEEDER SCREW
ШТУЦЕР ПРОКАЧКИ ТОРМОЗОВ

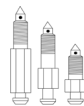

INDEKS
INDEX
ИНДЕКС



POŁOŻENIE
LOCATION
МЕСТО

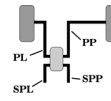

OPIS
DESCRIPTION
ОПИСАНИЕ

ZŁĄCZKA
FITTING
НАКОНЕЧНИК

ZŁĄCZKA
FITTING
НАКОНЕЧНИК

DŁUGOŚĆ
LENGTH
ДЛИНА

MARKA SAMOCHODU CAR MODEL МОДЕЛЬ АВТОМБИЛЯ	NUMER ZESTAWU SET NUMBER НОМЕР НАБОРА	ROK PRODUKCJI PRODUCTION YEAR ГОД ВЫПУСКА АВТОМБИЛЯ	ODPOWIETRZNIK BLEEDER SCREW ШТУЦЕР ПРОКАЧКИ ТОРМОЗОВ	INDEKS INDEX ИНДЕКС	POŁOŻENIE LOCATION МЕСТО	OPIS DESCRIPTION ОПИСАНИЕ
Toyota Hiace LH						
LH61	ZWP-8158	08.85>08.89	0017P	WP-130	ZPL	116 116 0250
				WP-130	ZPP	116 116 0250
				WP-022	PL	105 105 1350
				WP-031	PP	105 105 2100
				WP-493	TL	105 105X 1250
				WP-558	TP	105 105X 0500
				WP-039	SPL	105 105 1550
				WP-036	SPP	105 105 2100
				WP-559	STL	105 105 2350
				0019T	WP-047	STP
Toyota Hiace LH						
LH102	ZWP-8159	08.89>08.95	0086P	WP-039	PL	105 105 1550
				WP-039	PP	105 105 1550
				WP-556	TL	105 105X 0700
				WP-557	TP	105 105X 1100
				WP-039	SP	105 105 1550
				WP-039	SP+	105 105 1550
				WP-331	ST	105 105 2000
				WP-428	ST+	105 105 2050
				Toyota Hiace LH		
LH108	ZWP-8160	08.89>08.95	0086T	WP-356	PL	105 105 1450
				WP-356	PP	105 105 1450
				WP-556	TL	105 105X 0700
				WP-838	TP	105 105X 1050
				WP-039	SP	105 105 1550
				WP-039	SP+	105 105 1550
				WP-331	ST	105 105 2000
				WP-428	ST+	105 105 2050
				Toyota Hiace LH		
LH112	ZWP-8161	08.89>08.95	0086P	WP-039	PL	105 105 1550
				WP-039	PP	105 105 1550
				WP-556	TL	105 105X 0700
				WP-557	TP	105 105X 1100
				WP-039	SP	105 105 1550
				WP-039	SP+	105 105 1550
				WP-559	ST	105 105 2350
				WP-559	ST+	105 105 2350
				Toyota Hiace LXH		
LXH12 bez ABS without ABS без ABS	ZWP-8162	08.95>08.01	0017P	WP-117	PL	105 105 0750
				WP-027	PP	105 105 1250
				WP-024	TL	105 105 0800
				WP-836	TP	105 105X 0850
				WP-746	CL	105 116 2950
				0019T	WP-848	CP
Toyota Hiace LXH						
LXH12 z ABS with ABS с ABS	ZWP-8163	08.95>07.96	0017P	WP-117	PL	105 105 0750
				WP-013	PP	105 105 0900
				WP-835	TL	105 105X 0800
				WP-836	TP	105 105X 0850
				WP-747	CL	105 116 3000
				0019T	WP-848	CP
Toyota Hiace LXH						
LXH12 z ABS with ABS с ABS	ZWP-8163	08.96>08.01	0017P	WP-117	PL	105 105 0750
				WP-013	PP	105 105 0900
				WP-835	TL	105 105X 0800
				WP-836	TP	105 105X 0850
				WP-747	CL	105 116 3000
				0019T	WP-848	CP
Toyota Hiace RCH						
RCH12 bez ABS without ABS без ABS	ZWP-8162	08.95>	0086P	WP-117	PL	105 105 0750
				WP-027	PP	105 105 1250
				WP-024	TL	105 105 0800
				WP-836	TP	105 105X 0850
				WP-746	CL	105 116 2950
				0086T	WP-848	CP
Toyota Hiace RCH						
RCH12 z ABS with ABS с ABS	ZWP-8163	08.95>07.96	0086P	WP-117	PL	105 105 0750
				WP-013	PP	105 105 0900
				WP-835	TL	105 105X 0800
				WP-836	TP	105 105X 0850
				WP-747	CL	105 116 3000
				0086T	WP-848	CP
Toyota Hiace RCH						
RCH12 z ABS with ABS с ABS	ZWP-8163	08.96>	0086P	WP-117	PL	105 105 0750
				WP-013	PP	105 105 0900
				WP-835	TL	105 105X 0800
				WP-836	TP	105 105X 0850
				WP-747	CL	105 116 3000
				00086T	WP-848	CP

MARKA SAMOCHODU
CAR MODEL
МОДЕЛЬ АВТОМБИЯ

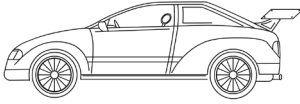

NUMER ZESTAWU
SET NUMBER
НОМЕР НАБОРА

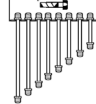

ROK PRODUKCJI
PRODUCTION YEAR
ГОД ВЫПУСКА АВТОМБИЯ



ODPOWIETRZNIK
BLEEDER SCREW
ШТУЦЕР ПРОКАЧКИ ТОРМОЗОВ

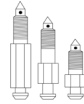

INDEKS
INDEX
ИНДЕКС



POŁOŻENIE
LOCATION
МЕСТО

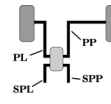

OPIS
DESCRIPTION
ОПИСАНИЕ

ZŁĄCZKA ZŁĄCZKA DŁUGOŚĆ
FITTING FITTING LENGTH
НАКОНЕЧНИК НАКОНЕЧНИК ДЛИНА

Toyota Hiace RH											
RH20	ZWP-8154	02.77>11.82	0086P	WP-024	PL	105 105 0800					
				WP-356	PP	105 105 1450					
				WP-034	TL	105 105 1200					
				WP-045	TP	105 105 0400					
				WP-356	CC	105 105 1450					
				WP-012	CC+	105 105 1650					
Toyota Hiace RH											
RH30	ZWP-8155	02.77>11.82	0086P	WP-024	PL	105 105 0800					
				WP-356	PP	105 105 1450					
				WP-034	TL	105 105 1200					
				WP-045	TP	105 105 0400					
				WP-356	CC	105 105 1450					
				WP-012	CC+	105 105 1650					
Toyota Hiace RZH											
RZH102, RZH103	ZWP-8159	08.89>08.95	0086P	WP-039	PL	105 105 1550					
				WP-039	PP	105 105 1550					
				WP-556	TL	105 105X 0700					
				WP-557	TP	105 105X 1100					
				WP-039	SP	105 105 1550					
				WP-039	SP+	105 105 1550					
Toyota Hiace RZH											
RZH112	ZWP-8161	08.89>08.95	0086P	WP-039	PL	105 105 1550					
				WP-039	PP	105 105 1550					
				WP-556	TL	105 105X 0700					
				WP-557	TP	105 105X 1100					
				WP-039	SP	105 105 1550					
				WP-039	SP+	105 105 1550					
Toyota Hiace YH											
YH5#	ZWP-8152	12.82>07.85	017P	WP-357	ZPL	105 116 0150					
				WP-357	ZPP	105 116 0150					
				WP-027	PL	105 105 1250					
				WP-428	PP	105 105 2050					
				WP-027	TL	105 105 1250					
				WP-005	TP	105 105 0450					
				WP-440	SPL	105 105 2150					
				WP-039	SPP	105 105 1550					
				*75				0086T	WP-440	STL	105 105 2150
				*75				0019T	WP-196	STP	105 105 1300
				Toyota Hiace YH							
				YH6#	ZWP-8153	12.82>07.85	0086T	WP-357	ZPL	105 116 0150	
WP-357	ZPP	105 116 0150									
WP-027	PL	105 105 1250									
WP-428	PP	105 105 2050									
WP-027	TL	105 105 1250									
WP-005	TP	105 105 0450									
WP-440	SPL	105 105 2150									
WP-039	SPP	105 105 1550									
*75								0086T	WP-390	STL	105 105 2250
*75								0086T	WP-047	STP	105 105 1500
Toyota Hiace YH											
YH51	ZWP-8174	08.85>08.89	0017P					WP-130	ZPL	116 116 0250	
				WP-130	ZPP	116 116 0250					
				WP-022	PL	105 105 1350					
				WP-036	PP	105 105 2100					
				WP-493	TL	105 105X 1250					
				WP-558	TP	105 105X 0500					
				WP-039	SPL	105 105 1550					
				WP-036	SPP	105 105 2100					
				*75				0019T	WP-031	STL	105 105 2200
				*75				0019T	WP-022	STP	105 105 1350
				Toyota Hiace YH							
				YH61	ZWP-8175	08.85>08.89	0086T	WP-130	ZPL	116 116 0250	
WP-130	ZPP	116 116 0250									
WP-022	PL	105 105 1350									
WP-036	PP	105 105 2100									
WP-493	TL	105 105X 1250									
WP-558	TP	105 105X 0500									
WP-039	SPL	105 105 1550									
WP-036	SPP	105 105 2100									
*75								0086T	WP-559	STL	105 105 2350
*75								0086T	WP-047	STP	105 105 1500

MARKA SAMOCHODU
CAR MODEL
МОДЕЛЬ АВТОМБИЯ

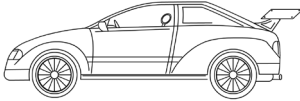

NUMER ZESTAWU
SET NUMBER
НОМЕР НАБОРА

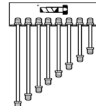

ROK PRODUKCJI
PRODUCTION YEAR
ГОД ВЫПУСКА АВТОМБИЯ



ODPOWIETRZNIK
BLEEDER SCREW
ШТУЦЕР ПРОКАЧКИ ТОРМОЗОВ

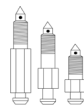

INDEKS
INDEX
ИНДЕКС



POŁOŻENIE
LOCATION
МЕСТО

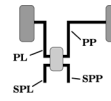

OPIS
DESCRIPTION
ОПИСАНИЕ

ZŁĄCZKA
FITTING
НАКОНЕЧНИК

ZŁĄCZKA
FITTING
НАКОНЕЧНИК

DŁUGOŚĆ
LENGTH
ДЛИНА

MARKA SAMOCHODU CAR MODEL МОДЕЛЬ АВТОМБИЯ	NUMER ZESTAWU SET NUMBER НОМЕР НАБОРА	ROK PRODUKCJI PRODUCTION YEAR ГОД ВЫПУСКА АВТОМБИЯ	ODPOWIETRZNIK BLEEDER SCREW ШТУЦЕР ПРОКАЧКИ ТОРМОЗОВ	INDEKS INDEX ИНДЕКС	POŁOŻENIE LOCATION МЕСТО	OPIS DESCRIPTION ОПИСАНИЕ
Toyota Hilux LN						
LN30	ZWP-8176	01.79>07.83	0017P	WP-018	PL	105 105 0650
				WP-010	PP	105 105 1850
				WP-034	TL	105 105 1200
				WP-005	TP	105 105 0450
				WP-708	CC	105 105 2850
Toyota Hilux LN						
LN36	ZWP-8177	01.79>07.83	0017P	WP-117	PL	105 105 0750
				WP-428	PP	105 105 2050
				WP-035	TL	105 105 1100
				WP-045	TP	105 105 0400
				WP-048	CC	105 105 2500
Toyota Hilux LN						
LN40, LN46	ZWP-8176	01.79>07.83	0017P	WP-018	PL	105 105 0650
				WP-010	PP	105 105 1850
				WP-034	TL	105 105 1200
				WP-005	TP	105 105 0450
				WP-708	CC	105 105 2850
Toyota Hilux LN						
LN55, LN56	ZWP-8179	08.83>91	0017P	WP-033	PL	105 105 0700
				WP-001	PP	105 105 0300
				WP-027	TL	105 105 1250
				WP-005	TP	105 105 0450
				WP-708	CL	105 105 2850
				WP-708	CP	105 105 2850
Toyota Hilux LN						
LN65	ZWP-8180	82>07.83	0017P	WP-117	PL	105 105 0750
				WP-041	PP	105 105 0350
				WP-035	TL	105 105 1100
				WP-005	TP	105 105 0450
				WP-708	CL	105 105 2850
				WP-708	CP	105 105 2850
Toyota Hilux LN						
LN65	ZWP-8181	08.83>91	0017P	WP-118	ZPL	116 116 0300
				WP-118	ZPP	116 116 0300
				WP-002	PL	105 105 0850
				WP-118	PP	116 116 0300
				WP-557	TL	105 105X 1100
				WP-028	TP	105 105 0550
				WP-016	CL	105 105 2900
				WP-016	CP	105 105 2900
Toyota Hilux LN						
LN85 stabilizator kabiny cabin stabilizer стабилизатор кабины	ZWP-8182	08.88>08.97	0017P	WP-578	ZPL	105 116 0300
				WP-578	ZPP	105 116 0300
				WP-002	PL	105 105 0850
				WP-001	PP	105 105 0300
				WP-839	TL	105 105X 1200
				WP-017	TP	105 105 0500
				WP-016	CL	105 105 2900
				WP-032	CP	105 105 2800
Toyota Hilux LN						
LN90 Pick-up	ZWP-8183	08.88>08.97	0017P	WP-578	ZPL	105 116 0300
				WP-578	ZPP	105 116 0300
				WP-002	PL	105 105 0850
				WP-001	PP	105 105 0300
				WP-839	TL	105 105X 1200
				WP-709	CL	105 105 3150
			0086T	WP-004	CP	105 105 3100
Toyota Hilux LN						
LN105 stabilizator kabiny cabin stabilizer стабилизатор кабины	ZWP-8184	08.88>08.97	0019P	WP-578	ZPL	105 116 0300
				WP-578	ZPP	105 116 0300
				WP-019	PL	105 105 1000
				WP-807	PP	116 116 0300
				WP-461	TL	105 116 1100
				WP-120	TP	116 116 0550
				WP-708	CC	105 105 2850
			0019T	WP-433	CC+	105 105 2950
Toyota Hilux LN						
LN110 Pick-up	ZWP-8185	08.88>08.97	0019P	WP-019	PL	105 105 1000
				WP-578	PL	105 116 0300
				WP-005	PP	105 105 0450
				WP-579	PP	105 116 0400
				WP-557	TL	105 105X 1100
				WP-001	TP	105 105 0300
				WP-040	CC	105 105 3300
			0019T	WP-040	CC+	105 105 3300

MARKA SAMOCHODU
CAR MODEL
МОДЕЛЬ АВТОМБИЯ

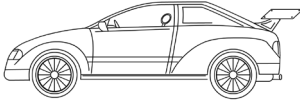

NUMER ZESTAWU
SET NUMBER
НОМЕР НАБОРА

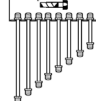

ROK PRODUKCJI
PRODUCTION YEAR
ГОД ВЫПУСКА АВТОМБИЯ



ODPOWIETRZNIK
BLEEDER SCREW
ШТУЦЕР ПРОКАЧКИ ТОРМОЗОВ

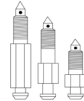

INDEKS
INDEX
ИНДЕКС



POŁOŻENIE
LOCATION
МЕСТО

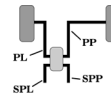

OPIS
DESCRIPTION
ОПИСАНИЕ

ZŁĄCZKA
FITTING
НАКОНЕЧНИК

ZŁĄCZKA
FITTING
НАКОНЕЧНИК

DŁUGOŚĆ
LENGTH
ДЛИНА

MARKA SAMOCHODU CAR MODEL МОДЕЛЬ АВТОМБИЯ	NUMER ZESTAWU SET NUMBER НОМЕР НАБОРА	ROK PRODUKCJI PRODUCTION YEAR ГОД ВЫПУСКА АВТОМБИЯ	ODPOWIETRZNIK BLEEDER SCREW ШТУЦЕР ПРОКАЧКИ ТОРМОЗОВ	INDEKS INDEX ИНДЕКС	POŁOŻENIE LOCATION МЕСТО	OPIS DESCRIPTION ОПИСАНИЕ
Toyota Hilux LN						
RN30, RN40	ZWP-8186	08.78>07.83	0017P	WP-018	PL	105 105 0650
				WP-012	PP	105 105 1650
				WP-034	TL	105 105 1200
				WP-005	TP	105 105 0450
				WP-708	CC	105 105 2850
Toyota Hilux LN						
YN56	ZWP-8179	08.83>91	0017P	WP-033	PL	105 105 0700
				WP-001	PP	105 105 0300
				WP-027	TL	105 105 1250
				WP-005	TP	105 105 0450
				WP-708	CL	105 105 2850
				WP-708	CP	105 105 2850
Toyota Hilux LN						
YN65, YN67	ZWP-8188	08.83>91	0017P	WP-118	ZPL	116 116 0300
				WP-118	ZPP	116 116 0300
				WP-001	PL	105 105 0300
				WP-118	PP	116 116 0300
				WP-557	TL	105 105X 1100
				WP-028	TP	105 105 0550
				WP-016	CL	105 105 2900
				WP-016	CP	105 105 2900
				Toyota Liteace		
CM3#, KM3#	ZWP-8189	10.85>	0086P	WP-027	PL	105 105 1250
				WP-047	PL	105 105 1500
				WP-018	PP	105 105 0650
				WP-047	PP	105 105 1500
				WP-265	TL	105 105 0950
				WP-018	TP	105 105 0650
			0086T	WP-256	SP	105 105 1750
				WP-024	ST	105 105 0800
				Toyota Picnic		
	ZWP-8190	09.97>04.01		WP-1676	PL	105 116 2250
				WP-353	PP	105 116 0950
				WP-579	TL	105 116 0400
				WP-515	TP	105 116 0750
				WP-912	CL	105 116 3900
				WP-350	CP	105 116 4600
Toyota Previa						
TCR11, TCR21 bez ABS without ABS без ABS	ZWP-8191	05.90>	0017P	WP-001	ZPL	105 105 0300
				WP-001	ZPP	105 105 0300
				WP-005	PL	105 105 0450
				WP-115	PP	105 105 1150
				WP-041	TL	105 105 0350
				WP-022	TP	105 105 1350
				WP-846	ZTL	105 116X 0300
				WP-846	ZTP	105 116X 0300
				WP-748	SPL	105 116 3100
				WP-751	SPP	105 116 3600
			0019T 0088T	WP-737	STL	105 116 0550
				WP-515	STP	105 116 0750
				Toyota Previa		
TCR11, TCR21 z ABS with ABS с ABS	ZWP-8192	05.90>07.93	0017P	WP-001	ZPL	105 105 0300
				WP-001	ZPP	105 105 0300
				WP-009	PL	105 105 0600
				WP-736	PP	105 116 0500
				WP-041	TL	105 105 0350
				WP-022	TP	105 105 1350
			0019T 0088T	WP-748	CL	105 116 3100
				WP-751	CP	105 116 3600
Toyota Previa						
TCR11, TCR21 z ABS with ABS с ABS	ZWP-8193	08.93>	0017P	WP-001	ZPL	105 105 0300
				WP-001	ZPP	105 105 0300
				WP-009	PL	105 105 0600
				WP-738	PP	105 116 0700
				WP-041	TL	105 105 0350
				WP-022	TP	105 105 1350
			0019T 0088T	WP-748	CL	105 116 3100
				WP-751	CP	105 116 3600
				Toyota RAV 4 II		
	ZWP-81114	06.00>02.06	0088P	WP-909	PL	105 116 2000
				WP-739	PP	105 116 0850
				WP-746	CL	105 116 2950
				WP-746	CP	105 116 2950
			0087T	WP-1874	TL	105 116X 0600
				WP-1874	TP	105 116X 0600

MARKA SAMOCHODU
CAR MODEL
МОДЕЛЬ АВТОМБИЯ

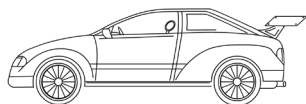

NUMER ZESTAWU
SET NUMBER
НОМЕР НАБОРА

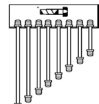

ROK PRODUKCJI
PRODUCTION YEAR
ГОД ВЫПУСКА АВТОМБИЯ



ODPOWIETRZNIK
BLEEDER SCREW
ШТУЦЕР ПРОКАЧКИ ТОРМОЗОВ



INDEKS
INDEX
ИНДЕКС



POŁOŻENIE
LOCATION
МЕСТО

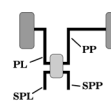

OPIS
DESCRIPTION
ОПИСАНИЕ

ZŁĄCZKA ZŁĄCZKA DŁUGOŚĆ
FITTING FITTING LENGTH
НАКОНЕЧНИК НАКОНЕЧНИК ДЛИНА

MARKA SAMOCHODU CAR MODEL МОДЕЛЬ АВТОМБИЯ	NUMER ZESTAWU SET NUMBER НОМЕР НАБОРА	ROK PRODUKCJI PRODUCTION YEAR ГОД ВЫПУСКА АВТОМБИЯ	ODPOWIETRZNIK BLEEDER SCREW ШТУЦЕР ПРОКАЧКИ ТОРМОЗОВ	INDEKS INDEX ИНДЕКС	POŁOŻENIE LOCATION МЕСТО	OPIS DESCRIPTION ОПИСАНИЕ
Toyota Sportsvan						
Wszystkie modele, z ABS All models, with ABS Все модели, с ABS	ZWP-8190	09.97>04.01		WP-1676	PL	105 116 2250
				WP-353	PP	105 116 0950
				WP-579	TL	105 116 0400
				WP-515	TP	105 116 0750
				WP-912	CL	105 116 3900
WP-350	CP	105 116 4600				
Toyota Starlet						
KP6# 3-drzwi, 5-drzwi, bez Sweden 3-doors, 5-doors, without Sweden 3-двери, 5-двери, без Sweden	ZWP-8195	78>84	0088P	WP-001	PL	105 105 0300
				WP-009	PP	105 105 0600
				WP-002	TL	105 105 0850
				WP-009	TP	105 105 0600
				WP-440	CC	105 105 2150
0086T						
Toyota Starlet						
EP7#	ZWP-8196	10.84>89	0088P	WP-355	PL	105 116 1150
				WP-018	PP	105 105 0650
				WP-041	TL	105 105 0350
				WP-041	TP	105 105 0350
				WP-352	CL	105 116 3800
WP-713	CP	105 105 4600				
*75			0086T			
Toyota Starlet						
EP8# bez ABS without ABS без ABS	ZWP-8197	12.89>10.96	0086P	WP-018	PL	105 105 0650
				WP-117	PP	105 105 0750
				WP-045	TL	105 105 0400
				WP-005	TP	105 105 0450
				WP-749	CL	105 116 3400
WP-756	CP	105 116 4550				
0086T						
Toyota Starlet						
EP8# z ABS with ABS с ABS	ZWP-8198	12.89>10.96	0086P	WP-018	PL	105 105 0650
				WP-580	PP	105 116 1300
				WP-045	TL	105 105 0400
				WP-005	TP	105 105 0450
				WP-749	CL	105 116 3400
WP-756	CP	105 116 4550				
0086T						
Toyota Starlet						
EP91 bez ABS without ABS без ABS	ZWP-81115	04.96>03.99		WP-908	PL	105 116 1500
				WP-018	PP	105 105 0650
				WP-530	CL	105 116 3250
				WP-754	CP	105 116 4400
				WP-579	TL	105 116 0400
WP-579	TP	105 116 0400				
Toyota Starlet						
EP91 z ABS with ABS с ABS	ZWP-81116	04.96>03.99	0088P 0086P	WP-1731	PL	105 116 1600
				WP-045	PP	105 105 0400
				WP-530	CL	105 116 3250
				WP-754	CP	105 116 4400
				WP-579	TL	105 116 0400
WP-579	TP	105 116 0400				
0086T						
Toyota Tercel						
AL11 Z	ZWP-8199	01.79>82	0088P	WP-001	PL	105 105 0300
				WP-041	PP	105 105 0350
				WP-005	TL	105 105 0450
				WP-005	TP	105 105 0450
				WP-004	CL	105 105 3100
WP-029	CP	105 105 3200				
0086T						
Totota Yaris						
Wszystkie modele, bez ABS, Francja All models, without ABS, France Все модели, без ABS, France	ZWP-81100	04.99>	0086P	WP-013	PL	105 105 0900
				WP-047	PP	105 105 1500
				WP-008	CL	105 105 3000
				WP-433	CP	105 105 2950
				WP-024	TL	105 105 0800
				WP-435	TP	105 105 1600
				WP-001	ZTL	105 105 0300
				WP-001	ZTP	105 105 0300
*66			0086T			
Toyota Yaris						
Wszystkie modele, z ABS, Francja All models, with ABS, France Все модели, с ABS, France	ZWP-81101	04.99>	0086P	WP-013	PL	105 105 0900
				WP-047	PP	105 105 1500
				WP-020	CL	105 105 3400
				WP-438	CP	105 105 4450
				WP-024	TL	105 105 0800
				WP-435	TP	105 105 1600
				WP-001	ZTL	105 105 0300
				WP-001	ZTP	105 105 0300
*66			0086T			
Toyota Yaris						
Wszystkie modele, bez ABS, Japan All models, without ABS, Japan Все модели, без ABS, Japan	ZWP-81102	04.99>	0086P	WP-906	PL	105 116 0600
				WP-580	PP	105 116 1300
				WP-821	CL	116 116 3000
				WP-821	CP	116 116 3000
				WP-357	ZTL	105 116 0150
				WP-357	ZTP	105 116 0150
*66			0086T			

MARKA SAMOCHODU
CAR MODEL
МОДЕЛЬ АВТОМБИЯ

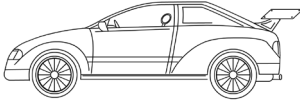

NUMER ZESTAWU
SET NUMBER
НОМЕР НАБОРА

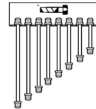

ROK PRODUKCJI
PRODUCTION YEAR
ГОД ВЫПУСКА АВТОМБИЯ



ODPOWIETRZNIK
BLEEDER SCREW
ШТУЦЕР ПРОКАЧКИ ТОРМОЗОВ

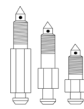

INDEKS
INDEX
ИНДЕКС



POŁOŻENIE
LOCATION
МЕСТО

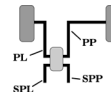

OPIS
DESCRIPTION
ОПИСАНИЕ

ZŁĄCZKA ZŁĄCZKA DŁUGOŚĆ
FITTING FITTING LENGTH
НАКОНЕЧНИК НАКОНЕЧНИК ДЛИНА

MARKA SAMOCHODU CAR MODEL МОДЕЛЬ АВТОМБИЯ	NUMER ZESTAWU SET NUMBER НОМЕР НАБОРА	ROK PRODUKCJI PRODUCTION YEAR ГОД ВЫПУСКА АВТОМБИЯ	ODPOWIETRZNIK BLEEDER SCREW ШТУЦЕР ПРОКАЧКИ ТОРМОЗОВ	INDEKS INDEX ИНДЕКС	POŁOŻENIE LOCATION МЕСТО	OPIS DESCRIPTION ОПИСАНИЕ			
Toyota Yaris									
Wszystkie modele, z ABS, Japan All models, with ABS, Japan Все модели, с ABS, Japan	ZWP-81103	04.99>	0086P	WP-579	PL	105 116 0400			
				WP-515	PP	105 116 0750			
				WP-821	CL	116 116 3000			
				WP-821	CP	116 116 3000			
				WP-357	ZTL	105 116 0150			
				WP-357	ZTP	105 116 0150			
*66			0086T						
Toyota Yaris									
Luna +VCS, Japan	ZWP-81104	04.99>	0086P	WP-579	PL	105 116 0400			
				WP-515	PP	105 116 0750			
				WP-752	CL	105 116 3650			
				WP-755	CP	105 116 4550			
				WP-357	ZTL	105 116 0150			
				WP-357	ZTP	105 116 0150			
Toyota Yaris Verso									
Wszystkie modele All models Все модели	ZWP-81105	11.99>	0086P	WP-1748	PL	105 105X 1800			
				WP-580	PP	105 116 1300			
				WP-751	CL	105 116 3600			
				WP-757	CP	105 116 4750			
				WP-736	TL	105 116 0500			
				WP-736	TP	105 116 1500			
				WP-846	ZTL	105 116X 0300			
				WP-846	ZTP	105 116X 0300			
				0086T					
Vauxhall Cavalier									
Wszystkie modele All models Все модели	ZWP-8201	77>81	0088P	WP-043	ZPL	105 105 0200			
				WP-043	ZPP	105 105 0200			
				WP-045	PL	105 105 0400			
				WP-034	PP	105 105 1200			
				WP-019	TL	105 105 1000			
				WP-009	TP	105 105 0600			
				WP-008	SP	105 105 3000			
				WP-045	ST	105 105 0400			
				0015T					
				Vauxhall Chevette					
Wszystkie modele All models Все модели	ZWP-8202	>78	0090P	WP-043	ZPL	105 105 0200			
				WP-043	ZPP	105 105 0200			
				WP-009	PL	105 105 0600			
				WP-039	PP	105 105 1550			
				WP-009	TL	105 105 0600			
				WP-002	TP	105 105 0850			
				WP-014	SP	105 105 2400			
				WP-045	ST	105 105 0400			
				0015T					
Vauxhall Chevette									
Wszystkie modele All models Все модели Nr HY127681	ZWP-8202	>78	0090P	WP-043	ZPL	105 105 0200			
				WP-043	ZPP	105 105 0200			
				WP-009	PL	105 105 0600			
				WP-039	PP	105 105 1550			
				WP-009	TL	105 105 0600			
				WP-002	TP	105 105 0850			
				WP-014	SP	105 105 2400			
				WP-045	ST	105 105 0400			
				0015T					
Vauxhall Viva HC									
Wszystkie modele All models Все модели	ZWP-8204	71>79	0049P	WP-061	ZPL	109 110 0300			
			0088P	WP-061	ZPP	109 110 0300			
			0108P	WP-727	PL	105 110 0650			
				WP-728	PP	105 110 1500			
				WP-073	TL	109 110 0550			
				WP-079	TP	109 109 1400			
				WP-729	CC	105 110 3150			
			0105T						
0049T									
Volvo 66									
Wszystkie modele All models Все модели	ZWP-8301	75>80	0086P	WP-117	PL	105 105 0750			
				WP-115	PP	105 105 1150			
				WP-034	TL	105 105 1200			
				WP-001	TP	105 105 0300			
				WP-021	CC	105 105 3600			
Volvo 140									
142, 144, 145	ZWP-8302	>70	0086P	WP-359	ZPL	111 115 0350			
			0120P	WP-359	ZPP	111 115 0350			
			0087P	WP-360	PL	111 115 0300			
				WP-360	PL	111 115 0300			
				WP-361	PP	111 115 0800			
				WP-361	PP	111 115 0800			
				WP-362	TL	111 115 0500			
				WP-363	TP	111 115 0950			
				WP-805	CL	115 115 2950			
				WP-364	CP	115 115 2800			

MARKA SAMOCHODU
CAR MODEL
МОДЕЛЬ АВТОМБИЯ

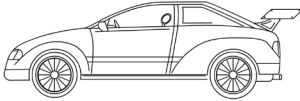

NUMER ZESTAWU
SET NUMBER
НОМЕР НАБОРА

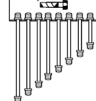

ROK PRODUKCJI
PRODUCTION YEAR
ГОД ВЫПУСКА АВТОМБИЯ



ODPOWIETRZNIK
BLEEDER SCREW
ШТУЦЕР ПРОКАЧКИ ТОРМОЗОВ

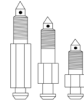

INDEKS
INDEX
ИНДЕКС



POŁOŻENIE
LOCATION
МЕСТО

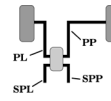

OPIS
DESCRIPTION
ОПИСАНИЕ

ZŁĄCZKA ZŁĄCZKA DŁUGOŚĆ
FITTING FITTING LENGTH
НАКОНЕЧНИК НАКОНЕЧНИК ДЛИНА

Volvo 140											
142, 144, 145	ZWP-8303	71>75	0086P 0120P 0087P	WP-359	ZPL	111 115 0350					
				WP-359	ZPP	111 115 0350					
				WP-360	PL	111 115 0300					
				WP-360	PL	111 115 0300					
				WP-361	PP	111 115 0800					
				WP-361	PP	111 115 0800					
				WP-362	TL	111 115 0500					
				WP-363	TP	111 115 0950					
				WP-379	SPL	111 115 1700					
				WP-383	SPP	111 115 0850					
				WP-381	STL	111 115 1100					
				WP-381	STP	111 115 1100					
Volvo 164											
Wszystkie modele All models Все модели	ZWP-8304	69>75	0053P 0120P 0120T	WP-359	ZPL	111 115 0350					
				WP-359	ZPP	111 115 0350					
				WP-360	PL	111 115 0300					
				WP-360	PL	111 115 0300					
				WP-383	PP	111 115 0850					
				WP-382	PP	111 115 0900					
				WP-362	TL	111 115 0500					
				WP-363	TP	111 115 0950					
				WP-364	CC	115 115 2800					
				WP-805	CC+	115 115 2950					
				Volvo 240/260							
				Wszystkie modele All models Все модели	ZWP-8305	75>12.77	0053P 0120P 0120T 0087T	WP-111	ZPL	105 106 0300	
WP-111	ZPL	105 106 0300									
WP-111	ZPP	105 106 0300									
WP-111	ZPP	105 106 0300									
WP-108	PL	105 106 0400									
WP-384	PL	105 106 0500									
WP-104	PP	105 106 1000									
WP-104	PP	105 106 1000									
WP-385	TL	105 106 0450									
WP-386	TP	105 106 1050									
WP-048	CL	105 105 2500									
WP-048	CP	105 105 2500									
Volvo 240/260											
Wszystkie modele All models Все модели	ZWP-8306	01.78>07.78	0053P 0120P 0120T 0087T	WP-111	ZPL	105 106 0300					
				WP-111	ZPL	105 106 0300					
				WP-111	ZPP	105 106 0300					
				WP-111	ZPP	105 106 0300					
				WP-111	PL	105 106 0300					
				WP-111	PL	105 106 0300					
				WP-387	PP	105 106 1200					
				WP-387	PP	105 106 1200					
				WP-005	TL	105 105 0450					
				WP-252	TP	105 105 1050					
				WP-014	CL	105 105 2400					
				WP-014	CP	105 105 2400					
Volvo 240/260											
Wszystkie modele All models Все модели	ZWP-8307	08.78>93	0053P 0120P 0120T 0087T	WP-041	ZPL	105 105 0350					
				WP-041	ZPL	105 105 0350					
				WP-041	ZPP	105 105 0350					
				WP-041	ZPP	105 105 0350					
				WP-001	PL	105 105 0300					
				WP-001	PL	105 105 0300					
				WP-034	PP	105 105 1200					
				WP-034	PP	105 105 1200					
				WP-385	TL	105 106 0450					
				WP-252	TP	105 105 1050					
				WP-014	CL	105 105 2400					
				WP-014	CP	105 105 2400					
Volvo 340											
B14, D16	ZWP-8308	79>08.90	0039P 0039T 0069T	WP-005	PL	105 105 0450					
				WP-027	PP	105 105 1250					
				WP-042	TL	105 105 1700					
				WP-001	TP	105 105 0300					
				WP-029	CC	105 105 3200					
Volvo 340											
B17 Nr 121000	ZWP-8309	86>08.90	0039P 0039T 0069T	WP-005	PL	105 105 0450					
				WP-022	PP	105 105 1350					
				WP-042	TL	105 105 1700					
				WP-006	TP	105 105 0250					
WP-008	CC	105 105 3000									
Volvo 340											
B19, B20	ZWP-8310	80>90	0039P 0039T 0069T	WP-017	PL	105 105 0500					
				WP-034	PP	105 105 1200					
				WP-010	TL	105 105 1850					
				WP-001	TP	105 105 0300					
				WP-029	CC	105 105 3200					

MARKA SAMOCHODU
CAR MODEL
МОДЕЛЬ АВТОМБИЯ

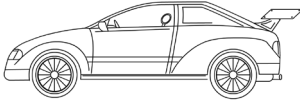

NUMER ZESTAWU
SET NUMBER
НОМЕР НАБОРА

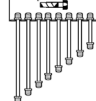

ROK PRODUKCJI
PRODUCTION YEAR
ГОД ВЫПУСКА АВТОМБИЯ



ODPOWIETRZNIK
BLEEDER SCREW
ШТУЦЕР ПРОКАЧКИ ТОРМОЗОВ

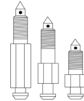

INDEKS
INDEX
ИНДЕКС



POŁOŻENIE
LOCATION
МЕСТО

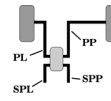

OPIS
DESCRIPTION
ОПИСАНИЕ

ZŁĄCZKA
FITTING
НАКОНЕЧНИК

ZŁĄCZKA
FITTING
НАКОНЕЧНИК

DŁUGOŚĆ
LENGTH
ДЛИНА

Volvo 340						
B20 Nr 121000	ZWP-8311	86>08.90	0039P	WP-005	PL	105 105 0450
				WP-022	PP	105 105 1350
				WP-023	TL	105 105 1800
			0039T	WP-001	TP	105 105 0300
			0069T	WP-008	CC	105 105 3000
Volvo 343						
Wszystkie modele All models Все модели Nr 376485	ZWP-8312	>79	0018P	WP-045	PL	105 105 0400
				WP-019	PP	105 105 1000
				WP-039	TL	105 105 1550
				WP-001	TP	105 105 0300
			0039T	WP-029	CC	105 105 3200
Volvo 343						
Wszystkie modele All models Все модели Nr 376486	ZWP-8314	79>82	0018P	WP-045	PL	105 105 0400
				WP-019	PP	105 105 1000
				WP-012	TL	105 105 1650
				WP-001	TP	105 105 0300
			0039T	WP-048	CC	105 105 2500
Volvo 360						
B14, D16	ZWP-8308	79>08.90	0039P	WP-005	PL	105 105 0450
				WP-027	PP	105 105 1250
				WP-042	TL	105 105 1700
			0039T	WP-001	TP	105 105 0300
			0069T	WP-029	CC	105 105 3200
Volvo 360						
B17 Nr 121000	ZWP-8309	79>08.90	0039P	WP-005	PL	105 105 0450
				WP-022	PP	105 105 1350
				WP-042	TL	105 105 1700
			0039T	WP-006	TP	105 105 0250
			0069T	WP-008	CC	105 105 3000
Volvo 360						
B19, B20	ZWP-8310	80>90	0039P	WP-017	PL	105 105 0500
				WP-034	PP	105 105 1200
				WP-010	TL	105 105 1850
			0039T	WP-001	TP	105 105 0300
			0069T	WP-029	CC	105 105 3200
Volvo 360						
B20 Nr 121000	ZWP-8311	86>08.89	0039P	WP-005	PL	105 105 0450
				WP-022	PP	105 105 1350
				WP-023	TL	105 105 1800
			0039T	WP-001	TP	105 105 0300
			0069T	WP-008	CC	105 105 3000
Volvo 440						
Wszystkie modele, bez ABS All models, without ABS Все модели, без ABS	ZWP-8319	88>92	0019P	WP-028	PL	105 105 0550
				WP-435	PP	105 105 1600
			0053T	WP-436	CL	105 105 4900
			0011T	WP-050	CP	105 105 4100
Volvo 440						
Wszystkie modele, bez ABS All models, without ABS Все модели, без ABS Nr 012931	ZWP-8320	88>89	0019P	WP-045	PL	105 105 0400
				WP-039	PP	105 105 1550
				WP-027	TL	105 105 1250
			0011T	WP-006	TP	105 105 0250
			0053T	WP-438	CC	105 105 4450
Volvo 440						
Wszystkie modele, bez ABS All models, without ABS Все модели, без ABS Nr 012932>336999	ZWP-8321	90>92	0019P	WP-045	PL	105 105 0400
				WP-042	PP	105 105 1700
				WP-027	TL	105 105 1250
			0053T	WP-006	TP	105 105 0250
			0011T	WP-438	CC	105 105 4450
Volvo 440						
Wszystkie modele, bez ABS, bez ASR, Nr 337000 All models, without ABS, without ASR, Nr 337000 Все модели, без ABS, без ASR, Nr 337000	ZWP-8322	93>96	0019P	WP-049	PP	105 105 1900
			0011T	WP-714	CL	105 105 5100
			0053T	WP-438	CP	105 105 4450
Volvo 440						
Wszystkie modele z ABS, z ASR, Nr 337000 All models, with ABS, with ASR, Nr 337000 Все модели, с ABS, с ASR, Nr 337000	ZWP-8322	93>96	0019P	WP-049	PP	105 105 1900
			0011T	WP-714	CL	105 105 5100
			0053T	WP-438	CP	105 105 4450
Volvo 444						
Wszystkie modele All models Все модели	ZWP-8324	59>67	0019P	WP-270	PL	115 115 0500
				WP-280	PP	115 115 0950
				WP-270	TL	115 115 0500
			0011T	WP-366	TP	115 115 1000
			0053T	WP-344	CC	115 115 2200
Volvo 460						
Wszystkie modele, bez ABS All models, without ABS Все модели, без ABS	ZWP-8319	88>92	0019P	WP-005	PL	105 105 0550
				WP-435	PP	105 105 1600
			0011T	WP-436	CL	105 105 4900
			0053T	WP-050	CP	105 105 4100

MARKA SAMOCHODU
CAR MODEL
МОДЕЛЬ АВТОМБИЯ

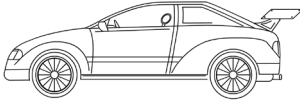

NUMER ZESTAWU
SET NUMBER
НОМЕР НАБОРА

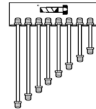

ROK PRODUKCJI
PRODUCTION YEAR
ГОД ВЫПУСКА АВТОМБИЯ



ODPOWIETRZNIK
BLEEDER SCREW
ШТУЦЕР ПРОКАЧКИ ТОРМОЗОВ

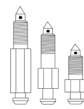

INDEKS
INDEX
ИНДЕКС



POŁOŻENIE
LOCATION
МЕСТО

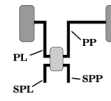

OPIS
DESCRIPTION
ОПИСАНИЕ

ZŁĄCZKA
FITTING
НАКОНЕЧНИК

ZŁĄCZKA
FITTING
НАКОНЕЧНИК

DŁUGOŚĆ
LENGTH
ДЛИНА

Volvo 460	ZWP-8320	88>89	0019P	WP-045	PL	105 105 0400
Wszystkie modele, z ABS All models, with ABS Все модели, с ABS Nr 012931				WP-039	PP	105 105 1550
				WP-027	TL	105 105 1250
			0011T	WP-006	TP	105 105 0250
			0053T	WP-438	CC	105 105 4450
Volvo 460						
Wszystkie modele, z ABS All models, with ABS Все модели, с ABS Nr 012932>336999	ZWP-8321	90>92	0019P	WP-045	PL	105 105 0400
				WP-042	PP	105 105 1700
				WP-027	TL	105 105 1250
			0011T	WP-006	TP	105 105 0250
			0053T	WP-438	CC	105 105 4450
Volvo 460						
Wszystkie modele, bez ABS, bez ASR, Nr 337000 All models, without ABS, without ASR, Nr 337000 Все модели, без ABS, без ASR, Nr 337000	ZWP-8322	93>	0019P	WP-049	PP	105 105 1900
			0011T	WP-714	CL	105 105 5100
			0053T	WP-438	CP	105 105 4450
Volvo 460						
Wszystkie modele, z ABS, z ASR, Nr 337000 All models, with ABS, with ASR, Nr 337000 Все модели, с ABS, с ASR, Nr 337000	ZWP-8322	93>96	0019P	WP-049	PP	105 105 1900
			0011T	WP-714	CL	105 105 5100
			0053T	WP-438	CP	105 105 4450
Volvo 544						
Wszystkie modele All models Все модели	ZWP-8324	59>67	0019P	WP-270	PL	115 115 0500
				WP-280	PP	115 115 0950
				WP-270	TL	115 115 0500
			0011T	WP-366	TP	115 115 1000
			0053T	WP-344	CC	115 115 2200
Volvo 740, 760						
Wszystkie modele, bez ABS All models, without ABS Все модели, без ABS Nr 337719	ZWP-8331	>84	0039P	WP-017	PL	105 105 0500
				WP-018	PL	105 105 0650
				WP-042	PP	105 105 1700
				WP-049	PP	105 105 1900
				WP-438	CL	105 105 4450
			0087T	WP-438	CP	105 105 4450
Volvo 740, 760						
Wszystkie modele, bez ABS All models, without ABS Все модели, без ABS Nr 337720	ZWP-8332	84>92	0039P	WP-017	PL	105 105 0500
				WP-018	PL	105 105 0650
				WP-440	PP	105 105 2150
				WP-440	PP	105 105 2150
				WP-534	CL	105 105 3750
			0087T	WP-438	CP	105 105 4450
Volvo 740, 760						
Wszystkie modele, bez ABS All models, without ABS Все модели, без ABS Nr 337719	ZWP-8331	>84	0039P	WP-017	PL	105 105 0500
				WP-018	PL	105 105 0650
				WP-042	PP	105 105 1700
				WP-049	PP	105 105 1900
				WP-438	CL	105 105 4450
			0087T	WP-438	CP	105 105 4450
Volvo 740, 760						
Wszystkie modele, bez ABS All models, without ABS Все модели, без ABS Nr 337720	ZWP-8334	84>92	0039P	WP-017	PL	105 105 0500
				WP-018	PL	105 105 0650
				WP-042	PP	105 105 1700
				WP-049	PP	105 105 1900
				WP-534	CL	105 105 3750
			0087T	WP-438	CP	105 105 4450
Volvo 850						
Wszystkie modele, bez Antispin All models, without Antispin Все модели, без Antispin	ZWP-8335	09.91>97	0019P	WP-387	PL	105 106 1200
				WP-047	PP	105 105 1500
				WP-018	TL	105 105 0650
				WP-018	TP	105 105 0650
				WP-013	TP	105 105 0900
			0087T	WP-439	CC	104 105 2900
Volvo 850						
Wszystkie modele, z Antispin All models, with Antispin Все модели, с Antispin	ZWP-8335	09.91>97	0019P	WP-387	PL	105 106 1200
				WP-047	PP	105 105 1500
				WP-018	TL	105 105 0650
				WP-018	TP	105 105 0650
				WP-013	TP	105 105 0900
			0087T	WP-439	CC	104 105 2900
Volvo 940						
Wszystkie modele, bez ABS, bez Diesel All models, without ABS, without Diesel Все модели, без ABS, без Diesel	ZWP-8337	91.	0039P	WP-017	PL	105 105 0500
				WP-009	PL	105 105 0600
				WP-440	PP	105 105 2150
				WP-440	PP	105 105 2150
				WP-029	CL	105 105 3200
			0087T	WP-021	CP	105 105 3600

MARKA SAMOCHODU
CAR MODEL
МОДЕЛЬ АВТОМБИЯ

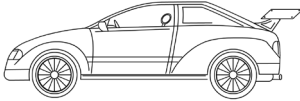

NUMER ZESTAWU
SET NUMBER
НОМЕР НАБОРА

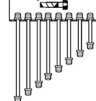

ROK PRODUKCJI
PRODUCTION YEAR
ГОД ВЫПУСКА АВТОМБИЯ



ODPOWIETRZNIK
BLEEDER SCREW
ШТУЦЕР ПРОКАЧКИ ТОРМОЗОВ

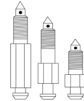

INDEKS
INDEX
ИНДЕКС



POŁOŻENIE
LOCATION
МЕСТО

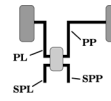

OPIS
DESCRIPTION
ОПИСАНИЕ

ZŁĄCZKA ZŁĄCZKA DŁUGOŚĆ
FITTING FITTING LENGTH
НАКОНЕЧНИК НАКОНЕЧНИК ДЛИНА

Volvo 940							
Bez B204E, B234F, Turbo, ABS	ZWP-8338	91.	0039P	WP-028	PL	105 105 0550	
				WP-013	PP	105 105 0900	
				WP-196	TL	105 105 1300	
				WP-042	TP	105 105 1700	
				WP-542	SP	104 104 2200	
*33			0087T	WP-042	ST	105 105 1700	
Volvo 940							
B204E, B234F, ABS bez Turbo without Turbo без Turbo	ZWP-8338	91.	0039P	WP-028	PL	105 105 0550	
				WP-013	PP	105 105 0900	
				WP-196	TL	105 105 1300	
				WP-042	TP	105 105 1700	
				WP-542	SP	104 104 2200	
*33			0087T	WP-042	ST	105 105 1700	
Volvo 940							
Turbo Diesel bez ABS without ABS без ABS	ZWP-8340	91.	0039P	WP-309	PL	104 105 0700	
				WP-017	PP	105 105 0500	
				WP-011	PP	105 105 2300	
				WP-196	TL	105 105 1300	
				WP-042	TP	105 105 1700	
*33			0087T	WP-479	SP	104 105 1200	
				WP-042	ST	105 105 1700	
Volvo 940							
Wszystkie modele, bez ABS All models, without ABS Все модели, без ABS	ZWP-8341	92>96	0039P	WP-018	PL	105 105 0650	
				WP-009	PP	105 105 0600	
				WP-047	PP	105 105 1500	
				WP-196	TL	105 105 1300	
				WP-042	TP	105 105 1700	
2x8" Servo			0087T	WP-499	SP	104 105 0650	
				WP-042	ST	105 105 1700	
Volvo 940							
Wszystkie modele, bez ABS All models, without ABS Все модели, без ABS	ZWP-8341	92>96	0039P	WP-018	PL	105 105 0650	
				WP-009	PP	105 105 0600	
				WP-047	PP	105 105 1500	
				WP-196	TL	105 105 1300	
				WP-042	TP	105 105 1700	
10" Servo			0087T	WP-499	SP	104 105 0650	
				WP-042	ST	105 105 1700	
Volvo 940							
Wszystkie modele, z ABS, bez Turbo All models, with ABS, without Turbo Все модели, с ABS, без Turbo	ZWP-8343	92>96	0039P	WP-018	PL	105 105 0650	
				WP-024	PP	105 105 0800	
				WP-513	PP	104 105 2250	
				WP-196	TL	105 105 1300	
				WP-042	TP	105 105 1700	
2x8" Servo			0087T	WP-398	SP	104 105 2100	
*33				WP-042	ST	105 105 1700	
Volvo 940							
Wszystkie modele, z ABS, bez Turbo All models, with ABS, without Turbo Все модели, с ABS, без Turbo	ZWP-8343	92>96	0039P	WP-018	PL	105 105 0650	
				WP-024	PP	105 105 0800	
				WP-513	PP	104 105 2250	
				WP-196	TL	105 105 1300	
				WP-042	TP	105 105 1700	
10" Servo			0087T	WP-398	SP	104 105 2100	
*33				WP-042	ST	105 105 1700	
Volvo 940							
Turbo Diesel z ABS with ABS с ABS	ZWP-8345	92>96	0039P	WP-264	PL	104 105 0750	
				WP-009	PP	105 105 0600	
				WP-031	PP	105 105 2200	
				WP-196	TL	105 105 1300	
				WP-042	TP	105 105 1700	
*33			0087T	WP-254	SP	104 105 1150	
				WP-042	ST	105 105 1700	
Volvo 960							
Wszystkie modele, bez ABS All models, without ABS Все модели, без ABS	ZWP-8337	91>	0039P	WP-017	PL	105 105 0500	
				WP-009	PP	105 105 0600	
				WP-440	PP	105 105 2150	
				WP-440	PP	105 105 2150	
				WP-029	CL	105 105 3200	
			0087T	WP-021	CP	105 105 3600	
Volvo 960							
Turbo Diesel 4-drzwi z ABS 4-doors with ABS 4-двери с ABS	ZWP-8347	91>	0039P	WP-309	PL	104 105 0700	
				WP-017	PP	105 105 0500	
				WP-440	PP	105 105 2150	
				WP-013	TL	105 105 0900	
				WP-356	TP	105 105 1450	
*33			0087T	WP-479	SP	104 105 1200	
				WP-042	ST	105 105 1700	

MARKA SAMOCHODU
CAR MODEL
МОДЕЛЬ АВТОМБИЯ

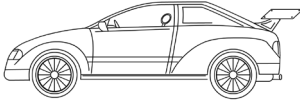

NUMER ZESTAWU
SET NUMBER
НОМЕР НАБОРА

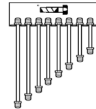

ROK PRODUKCJI
PRODUCTION YEAR
ГОД ВЫПУСКА АВТОМБИЯ



ODPOWIETRZNIK
BLEEDER SCREW
ШТУЦЕР ПРОКАЧКИ ТОРМОЗОВ

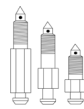

INDEKS
INDEX
ИНДЕКС



POŁOŻENIE
LOCATION
МЕСТО

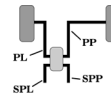

OPIS
DESCRIPTION
ОПИСАНИЕ

ZŁĄCZKA ZŁĄCZKA DŁUGOŚĆ
FITTING FITTING LENGTH
НАКОНЕЧНИК НАКОНЕЧНИК ДЛИНА

Volvo 960	ZWP-8348	91>	0039P	WP-309	PL	104 105 0700				
Turbo Diesel 5-drzwi z ABS 5-doors with ABS 5-двери с ABS				WP-017	PP	105 105 0500				
				WP-440	PP	105 105 2150				
				WP-196	TL	105 105 1300				
				WP-042	TP	105 105 1700				
				WP-479	SP	104 105 1200				
				WP-042	ST	105 105 1700				
*33			0087T							
Volvo 960	ZWP-8349	91>	0039P	WP-013	PL	105 105 0900				
V6 24V 4-drzwi 4-doors 4-двери				WP-542	PL	104 104 2200				
				WP-009	PP	105 105 0600				
				WP-013	TL	105 105 0900				
				WP-356	TP	105 105 1450				
				WP-583	SP	104 104 1900				
				WP-042	ST	105 105 1700				
0087T										
Volvo 960	ZWP-8350	91>	0039P	WP-013	PL	105 105 0900				
V6 24V 5-drzwi 5-doors 5-двери				WP-542	PL	104 104 2200				
				WP-009	PP	105 105 0600				
				WP-196	TL	105 105 1300				
				WP-042	TP	105 105 1700				
				WP-583	SP	104 104 1900				
				WP-042	ST	105 105 1700				
0087T										
Volvo 960	ZWP-8341	92>96	0039P	WP-018	PL	105 105 0650				
Wszystkie modele, bez ABS All models, without ABS Все модели, без ABS				WP-009	PP	105 105 0600				
				WP-047	PP	105 105 1500				
				WP-196	TL	105 105 1300				
				WP-042	TP	105 105 1700				
				WP-499	SP	104 105 0650				
				WP-042	ST	105 105 1700				
2x8" Servo			0087T							
Volvo 960	ZWP-8341	92>96	0039P	WP-018	PL	105 105 0650				
Wszystkie modele, bez ABS All models, without ABS Все модели, без ABS				WP-009	PP	105 105 0600				
				WP-047	PP	105 105 1500				
				WP-196	TL	105 105 1300				
				WP-042	TP	105 105 1700				
				WP-499	SP	104 105 0650				
				WP-042	ST	105 105 1700				
10" Servo			0087T							
Volvo 960	ZWP-8353	92>96	0039P	WP-264	PL	104 105 0750				
Turbo Diesel 4-drzwi z ABS 4-doors with ABS 4-двери с ABS				WP-009	PP	105 105 0600				
				WP-440	PP	105 105 2150				
				WP-013	TL	105 105 0900				
				WP-356	TP	105 105 1450				
				WP-254	SP	104 105 1150				
				WP-042	ST	105 105 1700				
*33			0087T							
Volvo 960	ZWP-8353	92>96	0039P	WP-264	PL	104 105 0750				
Turbo Diesel 5-drzwi z ABS 5-doors with ABS 5-двери с ABS				WP-009	PP	105 105 0600				
				WP-440	PP	105 105 2150				
				WP-013	TL	105 105 0900				
				WP-356	TP	105 105 1450				
				WP-254	SP	104 105 1150				
				WP-042	ST	105 105 1700				
0087T										
Volvo 960	ZWP-8355	92>96	0039P	WP-018	PL	105 105 0650				
V6 24V 4-drzwi 4-doors 4-двери				WP-584	PL	104 105 2200				
				WP-024	PP	105 105 0800				
				WP-013	TL	105 105 0900				
				WP-356	TP	105 105 1450				
				WP-484	SP	104 105 2000				
				WP-042	ST	105 105 1700				
*33			0087T							
Volvo 960	ZWP-8356	92>96	0039P	WP-018	PL	105 105 0650				
V6 24V 5-drzwi 5-doors 5-двери				WP-584	PL	104 105 2200				
				WP-024	PP	105 105 0800				
				WP-196	TL	105 105 1300				
				WP-042	TP	105 105 1700				
				WP-484	SP	104 105 2000				
				WP-042	ST	105 105 1700				
0087T										
Volvo S40	ZWP-8357	96>12.03	0010P	WP-404	PL	105 105 2550				
Wszystkie modele All models Все модели				WP-252	PP	105 105 1050				
				WP-709	CL	105 105 3150				
				WP-025	CP	105 105 4300				
				WP-004	POM-ABS	105 105 3100				
				WP-440	POM-ABS	105 105 2150				
				WP-440	TL	105 105 2150				
				WP-049	TP	105 105 1900				
				0100T						
				0053T						

MARKA SAMOCHODU
CAR MODEL
МОДЕЛЬ АВТОМБИЛЯ

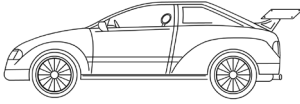

NUMER ZESTAWU
SET NUMBER
НОМЕР НАБОРА

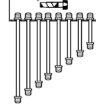

ROK PRODUKCJI
PRODUCTION YEAR
ГОД ВЫПУСКА АВТОМБИЛЯ



ODPOWIETRZNIK
BLEEDER SCREW
ШТУЦЕР ПРОКАЧКИ ТОРМОЗОВ

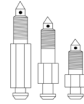

INDEKS
INDEX
ИНДЕКС



POŁOŻENIE
LOCATION
МЕСТО

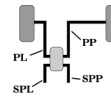

OPIS
DESCRIPTION
ОПИСАНИЕ

ZŁĄCZKA ZŁĄCZKA DŁUGOŚĆ
FITTING FITTING LENGTH
НАКОНЕЧНИК НАКОНЕЧНИК ДЛИНА

Volvo S70										
Wszystkie modele, 2WD All models, 2WD Все модели, 2WD	ZWP-8358	97>98	0120P	WP-254	PL	104 105 1150				
				WP-047	PP	105 105 1500				
				WP-018	TL	105 105 0650				
				WP-018	TP	105 105 0650				
				WP-013	TP	105 105 0900				
				WP-587	CC	104 105 2950				
				WP-045	POM-ABS	105 105 0400				
				WP-005	POM-ABS	105 105 0450				
			0087T							
Volvo S70										
Wszystkie modele, 2WD All models, 2WD Все модели, 2WD	ZWP-8359	99>00	0120P	WP-254	PL	104 105 1150				
				WP-047	PP	105 105 1500				
				WP-013	TP	105 105 0900				
				WP-587	SPL	104 105 2950				
				WP-016	SPP	105 105 2900				
				WP-018	STL	105 105 0650				
				WP-033	STP	105 105 0700				
							0087T			
Volvo V40										
Wszystkie modele All models Все модели	ZWP-8357	96>	0010P	WP-404	PL	105 105 2550				
				WP-252	PP	105 105 1050				
				WP-709	CL	105 105 3150				
				WP-025	CP	105 105 4300				
				WP-004	POM-ABS	105 105 3100				
				WP-440	POM-ABS	105 105 2150				
				WP-440	TL	105 105 2150				
				WP-049	TP	105 105 1900				
			0053T							
Volvo V50										
Wszystkie modele All models Все модели	ZWP-8364	04.04>		WP-1738	PL	104 105 X0600				
				WP-1747	PP	105 105X 1650				
				WP-1875	CL	105X 106 2400				
				WP-1735	CP	106 106 2700				
				WP-1882	TL	104 105 X0750				
				WP-922	TP	105 105X 0600				
				WP-013	TP	105 105 0900				
Volvo V70										
Wszystkie modele, 2WD All models, 2WD Все модели, 2WD	ZWP-8358	97>98	0019P	WP-254	PL	104 105 1150				
				WP-047	PP	105 105 1500				
				WP-018	TL	105 105 0650				
				WP-018	TP	105 105 0650				
				WP-013	TP	105 105 0900				
				WP-587	CC	104 105 2950				
				WP-045	POM-ABS	105 105 0400				
				WP-005	POM-ABS	105 105 0450				
							0087T			
Volvo V70										
Wszystkie modele, 2WD All models, 2WD Все модели, 2WD	ZWP-8359	99>	0019P	WP-254	PL	104 105 1150				
				WP-047	PP	105 105 1500				
				WP-013	TP	105 105 0900				
				WP-587	SPL	104 105 2950				
				WP-016	SPP	105 105 2900				
				WP-018	STL	105 105 0650				
				WP-033	STP	105 105 0700				
							0087P			
Volvo V70 II										
Wszystkie modele All models Все модели	ZWP-8363	05.00>		WP-024	PL	105 105 0800				
				WP-440	PP	105 105 2150				
				WP-440	CL	105 105 2150				
				WP-011	CP	105 105 2300				
				WP-003	TL	105 105 1400				
				WP-482	TP	105 105 1950				
VW 1200, 1300										
Wszystkie modele All models Все модели	ZWP-8401	67>70	0033P	WP-006	PL	105 105 0250				
				WP-009	PP	105 105 0600				
				WP-043	TL	105 105 0200				
				WP-018	TP	105 105 0650				
				WP-041	ZTL	105 105 0350				
				WP-041	ZTP	105 105 0350				
				WP-031	CC	105 105 2200				
*02			0033T							
VW 1200, 1300										
Wszystkie modele All models Все модели	ZWP-8402	71>79	0033P	WP-001	PL	105 105 0300				
				WP-024	PP	105 105 0800				
				WP-043	TL	105 105 0200				
				WP-018	TP	105 105 0650				
				WP-041	ZTL	105 105 0350				
				WP-041	ZTP	105 105 0350				
				WP-031	CC	105 105 2200				
*02			0033T							

MARKA SAMOCHODU
CAR MODEL
МОДЕЛЬ АВТОМБИЯ

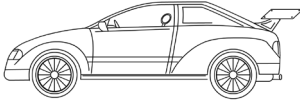

NUMER ZESTAWU
SET NUMBER
НОМЕР НАБОРА

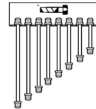

ROK PRODUKCJI
PRODUCTION YEAR
ГОД ВЫПУСКА АВТОМБИЯ



ODPOWIETRZNIK
BLEEDER SCREW
ШТУЦЕР ПРОКАЧКИ ТОРМОЗОВ

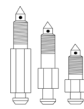

INDEKS
INDEX
ИНДЕКС



POŁOŻENIE
LOCATION
МЕСТО

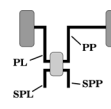

OPIS
DESCRIPTION
ОПИСАНИЕ

ZŁĄCZKA
FITTING
НАКОНЕЧНИК

ZŁĄCZKA
FITTING
НАКОНЕЧНИК

DŁUGOŚĆ
LENGTH
ДЛИНА

MARKA SAMOCHODU CAR MODEL МОДЕЛЬ АВТОМБИЯ	NUMER ZESTAWU SET NUMBER НОМЕР НАБОРА	ROK PRODUKCJI PRODUCTION YEAR ГОД ВЫПУСКА АВТОМБИЯ	ODPOWIETRZNIK BLEEDER SCREW ШТУЦЕР ПРОКАЧКИ ТОРМОЗОВ	INDEKS INDEX ИНДЕКС	POŁOŻENIE LOCATION МЕСТО	OPIS DESCRIPTION ОПИСАНИЕ
VW 1302, 1303						
Wszystkie modele All models Все модели *02	ZWP-8403	>75	0033P	WP-001	ZPL	105 105 0300
				WP-001	ZPP	105 105 0300
				WP-001	PL	105 105 0300
				WP-024	PP	105 105 0800
				WP-009	TP	105 105 0600
				WP-005	ZTL	105 105 0450
				WP-005	ZTP	105 105 0450
				WP-031	CC	105 105 2200
VW Bora						
z ABS, do Nr 1W 268 708 with ABS, to no. 1W 268 708 с ABS, к нет. 1W 268 708	ZWP-8497	10.98>01	0086P	WP-499	PL	104 105 0650
				WP-501	PP	104 105 0900
					TL	N/A
					TP	N/A
				WP-585	CL	104 105 2650
	WP-308	CP	104 105 3700			
VW Bora						
z ABS, do Nr 1W 268 709 with ABS, to no. 1W 268 709 с ABS, к нет. 1W 268 709	ZWP-8498	10.98>01	0086P	WP-441	PL	104 105 0500
				WP-435	PP	105 105 1600
					TL	N/A
					TP	N/A
				WP-585	CL	104 105 2650
	WP-030	CP	105 105 3700			
VW Caddy						
*73	ZWP-8404	83>93	0086P	WP-028	PL	105 105 0550
				WP-039	PP	105 105 1550
				WP-024	TL	105 105 0800
				WP-013	TP	105 105 0900
				WP-048	SPL	105 105 2500
				WP-167	SPP	105 105 2600
				WP-003	STL	105 105 1400
				WP-012	STP	105 105 1650
VW Caddy						
*74	ZWP-8405	83>93	0086P	WP-028	PL	105 105 0550
				WP-039	PP	105 105 1550
				WP-024	TL	105 105 0800
				WP-013	TP	105 105 0900
				WP-021	SPL	105 105 3600
				WP-021	SPP	105 105 3600
				WP-117	STL	105 105 0750
				WP-013	STP	105 105 0900
VW Derby						
Wszystkie modele All models Все модели *71 *73	ZWP-8406	75>08.81	0086P	WP-005	PL	105 105 0450
				WP-003	PP	105 105 1400
				WP-001	TL	105 105 0300
				WP-001	TP	105 105 0300
				WP-008	CL	105 105 3000
				WP-007	CP	105 105 3900
VW Derby						
Wszystkie modele All models Все модели *72 *73	ZWP-8407	75>08.81	0086P	WP-009	PL	105 105 0600
				WP-010	PP	105 105 1850
				WP-001	TL	105 105 0300
				WP-001	TP	105 105 0300
				WP-004	CL	105 105 3100
				WP-007	CP	105 105 3900
VW Derby						
Wszystkie modele All models Все модели Nr 867 2376 929 *71 *74	ZWP-8408	11.76>08.81	0086P	WP-005	PL	105 105 0450
				WP-003	PP	105 105 1400
				WP-117	TL	105 105 0750
				WP-022	TP	105 105 1350
				WP-001	ZTL	105 105 0300
				WP-001	ZTP	105 105 0300
				WP-390	CL	105 105 2250
				WP-048	CP	105 105 2500
VW Derby						
Wszystkie modele All models Все модели Nr 867 2376 929 *72 *74	ZWP-8409	11.76>08.81	0086P	WP-009	PL	105 105 0600
				WP-010	PP	105 105 1850
				WP-117	TL	105 105 0750
				WP-022	TP	105 105 1350
				WP-001	ZTL	105 105 0300
				WP-001	ZTP	105 105 0300
				WP-014	CL	105 105 2400
				WP-167	CP	105 105 2600
VW Derby						
Wszystkie modele All models Все модели *71	ZWP-8410	09.81>07.84	0086P	WP-017	PL	105 105 0500
				WP-010	PP	105 105 1850
				WP-001	ZTL	105 105 0300
				WP-001	ZTP	105 105 0300
				WP-008	CL	105 105 3000
				WP-030	CP	105 105 3700

MARKA SAMOCHODU
CAR MODEL
МОДЕЛЬ АВТОМБИЯ

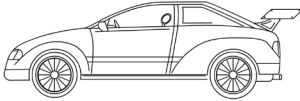

NUMER ZESTAWU
SET NUMBER
НОМЕР НАБОРА

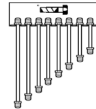

ROK PRODUKCJI
PRODUCTION YEAR
ГОД ВЫПУСКА АВТОМБИЯ



ODPOWIETRZNIK
BLEEDER SCREW
ШТУЦЕР ПРОКАЧКИ ТОРМОЗОВ

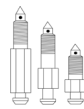

INDEKS
INDEX
ИНДЕКС



POŁOŻENIE
LOCATION
МЕСТО

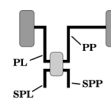

OPIS
DESCRIPTION
ОПИСАНИЕ

ZŁĄCZKA ZŁĄCZKA DŁUGOŚĆ
FITTING FITTING LENGTH
НАКОНЕЧНИК НАКОНЕЧНИК ДЛИНА

MARKA SAMOCHODU CAR MODEL МОДЕЛЬ АВТОМБИЯ	NUMER ZESTAWU SET NUMBER НОМЕР НАБОРА	ROK PRODUKCJI PRODUCTION YEAR ГОД ВЫПУСКА АВТОМБИЯ	ODPOWIETRZNIK BLEEDER SCREW ШТУЦЕР ПРОКАЧКИ ТОРМОЗОВ	INDEKS INDEX ИНДЕКС	POŁOŻENIE LOCATION МЕСТО	OPIS DESCRIPTION ОПИСАНИЕ
VW Derby						
Wszystkie modele All models Все модели *72 *73	ZWP-8411	09.81>07.84	0086P	WP-009	PL	105 105 0600
				WP-010	PP	105 105 1850
				WP-001	ZTL	105 105 0300
				WP-001	ZTP	105 105 0300
				WP-004	CL	105 105 3100
				WP-571	CP	105 105 3850
VW Derby						
Wszystkie modele All models Все модели *72 *74	ZWP-8412	09.81>07.84	0086P	WP-009	PL	105 105 0600
				WP-010	PP	105 105 1850
				WP-024	TL	105 105 0800
				WP-003	TP	105 105 1400
				WP-001	ZTL	105 105 0300
				WP-001	ZTP	105 105 0300
				WP-014	CL	105 105 2400
				WP-167	CP	105 105 2600
				VW Derby		
Wszystkie modele All models Все модели *72 *74	ZWP-8413	08.84>07.90	0086P	WP-009	PL	105 105 0600
				WP-010	PP	105 105 1850
				WP-013	TL	105 105 0900
				WP-039	TP	105 105 1550
				WP-001	ZTL	105 105 0300
				WP-001	ZTP	105 105 0300
				WP-014	CL	105 105 2400
				WP-048	CP	105 105 2500
				VW Golf		
*68 *73	ZWP-8414	>07.75	0086P	WP-006	ZPL	105 105 0250
				WP-006	ZPP	105 105 0250
				WP-028	PL	105 105 0550
				WP-027	PP	105 105 1250
				WP-028	TL	105 105 0550
				WP-028	TP	105 105 0550
				WP-011	CL	105 105 2300
				WP-032	CP	105 105 2800
VW Golf I						
Wszystkie modele All models Все модели Nr 17A0011705 *71 *73	ZWP-8415	>07.79	0086P	WP-009	PL	105 105 0600
				WP-034	PP	105 105 1200
				WP-028	TL	105 105 0550
				WP-028	TP	105 105 0550
				WP-011	CL	105 105 2300
				WP-032	CP	105 105 2800
VW Golf I						
Wszystkie modele All models Все модели Nr 17A0011705 *72 *74	ZWP-8416	>07.79	0086P	WP-017	PL	105 105 0500
				WP-003	PP	105 105 1400
				WP-006	TL	105 105 0250
				WP-039	TP	105 105 1550
				WP-028	ZTL	105 105 0550
				WP-028	ZTP	105 105 0550
				WP-011	SPL	105 105 2300
				WP-039	SPP	105 105 1550
				WP-428	STL	105 105 2050
				WP-012	STP	105 105 1650
VW Golf I						
Wszystkie modele All models Все модели Nr 17A0011705 *72 *73	ZWP-8417	>07.79	0086P	WP-017	PL	105 105 0500
				WP-003	PP	105 105 1400
				WP-028	TL	105 105 0550
				WP-028	TP	105 105 0550
				WP-011	CL	105 105 2300
				WP-032	CP	105 105 2800
VW Golf I						
Wszystkie modele All models Все модели Nr 17A0011706>1*-B-750000 *71 *73	ZWP-8418	08.79>07.81	0086P	WP-009	PL	105 105 0600
				WP-027	PP	105 105 1250
				WP-028	TL	105 105 0550
				WP-028	TP	105 105 0550
				WP-048	CL	105 105 2500
				WP-021	CP	105 105 3600
VW Golf I						
Wszystkie modele All models Все модели Nr 17A0011706>16-D-641909 *72 *74	ZWP-8419	08.79>07.83	0086P	WP-005	PL	105 105 0450
				WP-003	PP	105 105 1400
				WP-006	TL	105 105 0250
				WP-039	TP	105 105 1550
				WP-028	ZTL	105 105 0550
				WP-028	ZTP	105 105 0550
				WP-006	SPL	105 105 0250
				WP-041	SPP	105 105 0350
				WP-390	STL	105 105 2250
				WP-048	STP	105 105 2500
				VW Golf I		

MARKA SAMOCHODU
CAR MODEL
МОДЕЛЬ АВТОМБИЯ

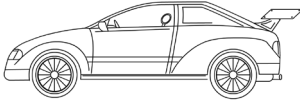

NUMER ZESTAWU
SET NUMBER
НОМЕР НАБОРА

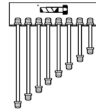

ROK PRODUKCJI
PRODUCTION YEAR
ГОД ВЫПУСКА АВТОМБИЯ



ODPOWIETRZNIK
BLEEDER SCREW
ШТУЦЕР ПРОКАЧКИ ТОРМОЗОВ

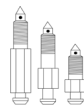

INDEKS
INDEX
ИНДЕКС



POŁOŻENIE
LOCATION
МЕСТО

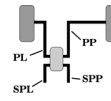

OPIS
DESCRIPTION
ОПИСАНИЕ

ZŁĄCZKA
FITTING
НАКОНЕЧНИК

ZŁĄCZKA
FITTING
НАКОНЕЧНИК

DŁUGOŚĆ
LENGTH
ДЛИНА

MARKA SAMOCHODU CAR MODEL МОДЕЛЬ АВТОМБИЯ	NUMER ZESTAWU SET NUMBER НОМЕР НАБОРА	ROK PRODUKCJI PRODUCTION YEAR ГОД ВЫПУСКА АВТОМБИЯ	ODPOWIETRZNIK BLEEDER SCREW ШТУЦЕР ПРОКАЧКИ ТОРМОЗОВ	INDEKS INDEX ИНДЕКС	POŁOŻENIE LOCATION МЕСТО	OPIS DESCRIPTION ОПИСАНИЕ
VW Golf I						
Wszystkie modele All models Все модели Nr 17A0011706>16-D-641909 *72 *73	ZWP-8420	08.79>07.83	0086P	WP-005	PL	105 105 0450
				WP-003	PP	105 105 1400
				WP-028	TL	105 105 0550
				WP-028	TP	105 105 0550
			0033T	WP-048	CL	105 105 2500
			0013T	WP-021	CP	105 105 3600
VW Golf II						
Wszystkie modele, bez ABS All models, without ABS Все модели, без ABS Nr 19-E-300001>LB300000 *72 *73	ZWP-8421	08.83>07.90	0086P	WP-009	PL	105 105 0600
				WP-196	PP	105 105 1300
				WP-018	ZTL	105 105 0650
				WP-018	ZTP	105 105 0650
				WP-048	CL	105 105 2500
			0033T	WP-046	CP	105 105 3500
VW Golf II						
Wszystkie modele, bez ABS All models, without ABS Все модели, без ABS Nr 19-E-300001>1G-NW300000 *72 *74	ZWP-8422	08.83>07.92	0086P	WP-009	PL	105 105 0600
				WP-196	PP	105 105 1300
				WP-005	TL	105 105 0450
				WP-196	TP	105 105 1300
				WP-018	ZTL	105 105 0650
				WP-018	ZTP	105 105 0650
				WP-559	CL	105 105 2350
			0033T	WP-706	CP	105 105 2450
VW Golf II						
Wszystkie modele, z ABS All models, with ABS Все модели, с ABS Nr 19H-000001>19JB-200000	ZWP-8423	08.86>07.88	0086P	WP-009	PL	105 105 0600
				WP-047	PP	105 105 1500
				WP-045	TL	105 105 0400
				WP-196	TP	105 105 1300
				WP-028	ZTL	105 105 0550
				WP-028	ZTP	105 105 0550
				WP-001	SP	105 105 0300
			0033T	WP-014	ST	105 105 2400
VW Golf II						
Wszystkie modele, z ABS All models, with ABS Все модели, с ABS Nr 1G-KB000001>1G-KB200000	ZWP-8424	0.88>07.89	0086P	WP-028	PL	105 105 0550
				WP-047	PP	105 105 1500
				WP-045	TL	105 105 0400
				WP-027	TP	105 105 1250
				WP-017	ZTL	105 105 0500
				WP-017	ZTP	105 105 0500
				WP-001	SP	105 105 0300
			0033T	WP-014	ST	105 105 2400
VW Golf II						
Wszystkie modele, z ABS All models, with ABS Все модели, с ABS Nr 1G-LB-000001>1G-NB-300000 *66	ZWP-8425	08.89>07.92	0086P	WP-028	PL	105 105 0550
				WP-039	PP	105 105 1550
				WP-045	TL	105 105 0400
				WP-022	TP	105 105 1350
				WP-009	ZTL	105 105 0600
				WP-009	ZTP	105 105 0600
			0013T	WP-041	SP	105 105 0350
			0019T	WP-014	ST	105 105 2400
VW Golf II						
Wszystkie modele, z ABS All models, with ABS Все модели, с ABS Nr 1G-LB-000001>1G-NB-300000 *66	ZWP-8426	08.89>07.92	0086P	WP-028	PL	105 105 0550
				WP-039	PP	105 105 1550
				WP-045	TL	105 105 0400
				WP-022	TP	105 105 1350
				WP-017	ZTL	105 105 0500
				WP-017	ZTP	105 105 0500
			0013T	WP-001	SP	105 105 0300
			0019T	WP-014	ST	105 105 2400
VW Golf III						
2-drzwi, bez ABS 2-doors, without ABS 2-двери, без ABS Variant, Nr 1H-N-000001>1H-VD500000, 1H-VE600000 *66 *73	ZWP-8427	11.91>07.97	0086P	WP-005	PL	105 105 0450
				WP-022	PP	105 105 1350
				WP-024	TL	105 105 0800
				WP-013	TP	105 105 0900
				WP-707	CL	105 105 2650
			0019T	WP-534	CP	105 105 3750
VW Golf III						
2-drzwi, z ABS 2-doors, with ABS 2-двери, с ABS Variant, Nr 1H-N-000001>1H-VD500000, 1H-VW-600000 *66 *74	ZWP-8428	11.91>07.97	0086P	WP-005	PL	105 105 0450
				WP-022	PP	105 105 1350
				WP-024	TL	105 105 0800
				WP-013	TP	105 105 0900
				WP-707	CL	105 105 2650
			0019T	WP-533	CP	105 105 2750
VW Golf III						
2-drzwi, bez ABS 2-doors, without ABS 2-двери, без ABS Variant, Nr 1H-N-000001>1H-VD500000, 1H-VW600000 *67 *74	ZWP-8429	11.91>07.97	0086P	WP-005	PL	105 105 0450
				WP-022	PP	105 105 1350
				WP-018	TL	105 105 0650
				WP-024	TP	105 105 0800
				WP-707	CL	105 105 2650
			0019T	WP-533	CP	105 105 2750

MARKA SAMOCHODU
CAR MODEL
МОДЕЛЬ АВТОМБИЯ

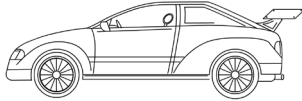

NUMER ZESTAWU
SET NUMBER
НОМЕР НАБОРА

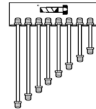

ROK PRODUKCJI
PRODUCTION YEAR
ГОД ВЫПУСКА АВТОМБИЯ



ODPOWIETRZNIK
BLEEDER SCREW
ШТУЦЕР ПРОКАЧКИ ТОРМОЗОВ

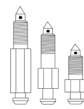

INDEKS
INDEX
ИНДЕКС



POŁOŻENIE
LOCATION
МЕСТО

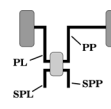

OPIS
DESCRIPTION
ОПИСАНИЕ

ZŁĄCZKA FITTING
НАКОНЕЧНИК

ZŁĄCZKA FITTING
НАКОНЕЧНИК

DŁUGOŚĆ LENGTH
ДЛИНА

MARKA SAMOCHODU CAR MODEL МОДЕЛЬ АВТОМБИЯ	NUMER ZESTAWU SET NUMBER НОМЕР НАБОРА	ROK PRODUKCJI PRODUCTION YEAR ГОД ВЫПУСКА АВТОМБИЯ	ODPOWIETRZNIK BLEEDER SCREW ШТУЦЕР ПРОКАЧКИ ТОРМОЗОВ	INDEKS INDEX ИНДЕКС	POŁOŻENIE LOCATION МЕСТО	OPIS DESCRIPTION ОПИСАНИЕ				
VW Golf III										
Wszystkie modele z ABS Nr 1H-N-000001>1H-RW99000 1H-RB200000, 1H-RP990000	ZWP-8430	11.91>06.94	0086P	WP-045	PL	105 105 0400				
				WP-022	PP	105 105 1350				
				WP-024	TL	105 105 0800				
				WP-013	TP	105 105 0900				
				WP-707	CL	105 105 2650				
				WP-015	CP	105 105 2700				
VW Golf III										
Wszystkie modele, z ABS All models, with ABS Все модели, с ABS Nr 1H-N-000001>1H-RW990000 1H-RB200000, 1H-RP990000	ZWP-8431	11.91>06.94	0086P	WP-045	PL	105 105 0400				
				WP-022	PP	105 105 1350				
				WP-018	TL	105 105 0650				
				WP-024	TP	105 105 0800				
				WP-707	CL	105 105 2650				
				WP-707	CP	105 105 2650				
VW Golf IV										
Wszystkie modele, z ABS, do Nr 1W 268 708 All models, with ABS, to no. 1W 268 708 Все модели, с ABS, к нет. 1W 268 708	ZWP-8499	08.97>01	0019P	WP-499	PL	104 105 0650				
				WP-013	PP	105 105 0900				
					TL	N/A				
					TP	N/A				
				WP-585	CL	104 105 2650				
				WP-030	CP	105 105 3700				
VW Golf IV										
Wszystkie modele, z ABS, do Nr 1W 268 708 All models, with ABS, to no. 1W 268 708 Все модели, с ABS, к нет. 1W 268 708	ZWP-8498	01>09.03	0019P	WP-441	PL	104 105 0500				
				WP-435	PP	105 105 1600				
					TL	N/A				
					TP	N/A				
				WP-585	CL	104 105 2650				
				WP-030	CP	105 105 3700				
VW Jetta										
Wszystkie modele All models Все модели Nr 16A0000001>1*-B-750000 *71 *73	ZWP-8418	08.79>07.81	0086P	WP-009	PL	105 105 0600				
				WP-027	PP	105 105 1250				
				WP-028	TL	105 105 0550				
				WP-028	TP	105 105 0550				
				WP-048	CL	105 105 2500				
				WP-021	CP	105 105 3600				
VW Jetta										
Wszystkie modele All models Все модели Nr 16A0000001>16-D-641909 *72 *73	ZWP-8420	08.79>07.83	0086P	WP-005	PL	105 105 0450				
				WP-003	PP	105 105 1400				
				WP-028	TL	105 105 0550				
				WP-028	TP	105 105 0550				
				WP-048	CL	105 105 2500				
				WP-021	CP	105 105 3600				
VW Jetta										
Wszystkie modele All models Все модели Nr 16A0000001>16-D-641909 *72 *74	ZWP-8419	08.79>07.83	0086P	WP-005	PL	105 105 0450				
				WP-003	PP	105 105 1400				
				WP-006	TL	105 105 0250				
				WP-039	TP	105 105 1550				
				WP-028	ZTL	105 105 0550				
				WP-028	ZTP	105 105 0550				
				WP-006	SPL	105 105 0250				
				WP-041	SPP	105 105 0350				
				WP-390	STL	105 105 2250				
				WP-048	STP	105 105 2500				
				VW Jetta						
				Wszystkie modele, bez ABS All models, without ABS Все модели, без ABS Nr 16-E-010001>1G-LW990000 *72 *73	ZWP-8421	08.83>07.90	0086P	WP-009	PL	105 105 0600
WP-196	PP	105 105 1300								
WP-018	ZTL	105 105 0650								
WP-018	ZTP	105 105 0650								
WP-048	CL	105 105 2500								
WP-046	CP	105 105 3500								
VW Jetta										
Wszystkie modele, bez ABS All models, without ABS Все модели, без ABS Nr 16-E-010001>1G-NW300000 *72 *74	ZWP-8422	0.83>07.92	0086P	WP-009	PL	105 105 0600				
				WP-196	PP	105 105 1300				
				WP-005	TL	105 105 0450				
				WP-196	TP	105 105 1300				
				WP-018	ZTL	105 105 0650				
				WP-018	ZTP	105 105 0650				
				WP-559	CL	105 105 2350				
				WP-706	CP	105 105 2450				
				VW Jetta						
				Wszystkie modele, z ABS All models, with ABS Все модели, с ABS Nr 16H-000001>16JW-990000	ZWP-8423	08.86>07.88	0086P	WP-009	PL	105 105 0600
WP-047	PP	105 105 1500								
WP-045	TL	105 105 0400								
WP-196	TP	105 105 1300								
WP-028	ZTL	105 105 0550								
WP-028	ZTP	105 105 0550								
WP-001	SP	105 105 0300								
WP-014	ST	105 105 2400								
VW Jetta										

MARKA SAMOCHODU
CAR MODEL
МОДЕЛЬ АВТОМБИЯ

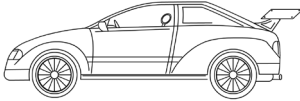

NUMER ZESTAWU
SET NUMBER
НОМЕР НАБОРА

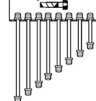

ROK PRODUKCJI
PRODUCTION YEAR
ГОД ВЫПУСКА АВТОМБИЯ



ODPOWIETRZNIK
BLEEDER SCREW
ШТУЦЕР ПРОКАЧКИ ТОРМОЗОВ

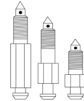

INDEKS
INDEX
ИНДЕКС



POŁOŻENIE
LOCATION
МЕСТО

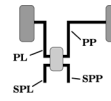

OPIS
DESCRIPTION
ОПИСАНИЕ

ZŁĄCZKA
FITTING
НАКОНЕЧНИК

ZŁĄCZKA
FITTING
НАКОНЕЧНИК

DŁUGOŚĆ
LENGTH
ДЛИНА

MARKA SAMOCHODU CAR MODEL МОДЕЛЬ АВТОМБИЯ	NUMER ZESTAWU SET NUMBER НОМЕР НАБОРА	ROK PRODUKCJI PRODUCTION YEAR ГОД ВЫПУСКА АВТОМБИЯ	ODPOWIETRZNIK BLEEDER SCREW ШТУЦЕР ПРОКАЧКИ ТОРМОЗОВ	INDEKS INDEX ИНДЕКС	POŁOŻENIE LOCATION МЕСТО	OPIS DESCRIPTION ОПИСАНИЕ				
VW Jetta										
Wszystkie modele, z ABS All models, with ABS Все модели, с ABS Nr 1G-KW-000001>1G-KW-200000	ZWP-8424	08.88>07.89	0086P	WP-028	PL	105 105 0550				
				WP-047	PP	105 105 1500				
				WP-045	TL	105 105 0400				
				WP-027	TP	105 105 1250				
				WP-017	ZTL	105 105 0500				
				WP-017	ZTP	105 105 0500				
				WP-001	SP	105 105 0300				
				WP-014	ST	105 105 2400				
			0033T							
VW Jetta										
Wszystkie modele, z ABS All models, with ABS Все модели, с ABS Nr 1G-LW-000001>1G-NW-300000	ZWP-8425	08.89>07.92	0086P	WP-028	PL	105 105 0550				
				WP-039	PP	105 105 1550				
				WP-045	TL	105 105 0400				
				WP-022	TP	105 105 1350				
				WP-009	ZTL	105 105 0600				
				WP-009	ZTP	105 105 0600				
				WP-041	SP	105 105 0350				
				WP-014	ST	105 105 2400				
			0033T							
*66										
VW Jetta										
Wszystkie modele, z ABS All models, with ABS Все модели, с ABS Nr 1G-LW-000001>1G-NW-300000	ZWP-8426	08.89>07.92	0086P	WP-028	PL	105 105 0550				
				WP-039	PP	105 105 1550				
				WP-045	TL	105 105 0400				
				WP-022	TP	105 105 1350				
				WP-017	ZTL	105 105 0500				
				WP-017	ZTP	105 105 0500				
				WP-001	SP	105 105 0300				
				WP-014	ST	105 105 2400				
			0033T							
*67										
VW Lupo										
Wszystkie modele All models Все модели	ZWP-8441	99>	0086P	WP-009	PL	105 105 0600				
				WP-035	PP	105 105 1100				
				WP-018	TL	105 105 0650				
				WP-024	TP	105 105 0800				
				WP-706	CL	105 105 2450				
				WP-048	CP	105 105 2500				
			0033T							
*66										
VW LT										
28, 31	ZWP-8442	75>96	0087P	WP-043	ZPL	105 105 0200				
				WP-043	ZPP	105 105 0200				
				WP-001	PL	105 105 0300				
				WP-252	PP	105 105 1050				
				WP-018	TL	105 105 0650				
				WP-196	TP	105 105 1300				
				WP-009	SPL	105 105 0600				
				WP-117	SPP	105 105 0750				
				WP-021	STL	105 105 3600				
				WP-048	STP	105 105 2500				
							0033T			
VW LT										
35 rozstaw osi 2500 mm wheel base 2500 mm колесная база 2500 мм	ZWP-8443	75>96	0087P	WP-043	ZPL	105 105 0200				
				WP-043	ZPP	105 105 0200				
				WP-001	PL	105 105 0300				
				WP-252	PP	105 105 1050				
				WP-005	TL	105 105 0450				
				WP-115	TP	105 105 1150				
				WP-009	SPL	105 105 0600				
				WP-117	SPP	105 105 0750				
				WP-030	STL	105 105 3700				
				WP-048	STP	105 105 2500				
							0033T			
VW LT										
35 rozstaw osi 2950 mm wheel base 2950 mm колесная база 2950 мм	ZWP-8444	75>96	0087P	WP-043	ZPL	105 105 0200				
				WP-043	ZPP	105 105 0200				
				WP-001	PL	105 105 0300				
				WP-252	PP	105 105 1050				
				WP-005	TL	105 105 0450				
				WP-115	TP	105 105 1150				
				WP-009	SPL	105 105 0600				
				WP-117	SPP	105 105 0750				
				WP-050	STL	105 105 4100				
				WP-016	STP	105 105 2900				
							0033T			
VW Lupo										
Wszystkie modele All models Все модели	ZWP-8441	99>12.05		WP-009	PL	105 105 0600				
				WP-035	PP	105 105 1100				
				WP-706	CL	105 105 2450				
				WP-048	CP	105 105 2500				
				WP-018	TL	105 105 0650				
				WP-024	TP	105 105 0800				
VW Passat										
Wszystkie modele All models Все модели	ZWP-8445	10.74>07.77	0086P	WP-009	PL	105 105 0600				
				WP-013	PP	105 105 0900				
				WP-017	TL	105 105 0500				
				WP-017	TP	105 105 0500				
				WP-015	CL	105 105 2700				
				WP-432	CP	105 105 3250				
			0013T							
			0033T							
*71										

MARKA SAMOCHODU
CAR MODEL
МОДЕЛЬ АВТОМБИЯ

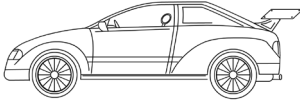

NUMER ZESTAWU
SET NUMBER
НОМЕР НАБОРА

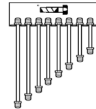

ROK PRODUKCJI
PRODUCTION YEAR
ГОД ВЫПУСКА АВТОМБИЯ



ODPOWIETRZNIK
BLEEDER SCREW
ШТУЦЕР ПРОКАЧКИ ТОРМОЗОВ

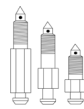

INDEKS
INDEX
ИНДЕКС



POŁOŻENIE
LOCATION
МЕСТО

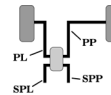

OPIS
DESCRIPTION
ОПИСАНИЕ

ZŁĄCZKA ZŁĄCZKA DŁUGOŚĆ
FITTING FITTING LENGTH
НАКОНЕЧНИК НАКОНЕЧНИК ДЛИНА

MARKA SAMOCHODU CAR MODEL МОДЕЛЬ АВТОМБИЯ	NUMER ZESTAWU SET NUMBER НОМЕР НАБОРА	ROK PRODUKCJI PRODUCTION YEAR ГОД ВЫПУСКА АВТОМБИЯ	ODPOWIETRZNIK BLEEDER SCREW ШТУЦЕР ПРОКАЧКИ ТОРМОЗОВ	INDEKS INDEX ИНДЕКС	POŁOŻENIE LOCATION МЕСТО	OPIS DESCRIPTION ОПИСАНИЕ
VW Passat						
Wszystkie modele All models Все модели	ZWP-8446	10.74>07.77	0086P	WP-117	PL	105 105 0750
				WP-019	PP	105 105 1000
				WP-017	TL	105 105 0500
				WP-017	TP	105 105 0500
*72			0013T	WP-708	CL	105 105 2850
*73			0033T	WP-020	CP	105 105 3400
VW Passat						
Wszystkie modele All models Все модели	ZWP-8447	10.74>07.77	0086P	WP-117	PL	105 105 0750
				WP-252	PP	105 105 1050
				WP-013	TL	105 105 0900
				WP-023	TP	105 105 1800
				WP-017	ZTL	105 105 0500
				WP-017	ZTP	105 105 0500
*72			0033T	WP-007	CL	105 105 3900
*74			0013T	WP-020	CP	105 105 3400
VW Passat						
Limousine bez Aut.	ZWP-8448	08.77>07.84	0086P	WP-024	PL	105 105 0800
				WP-035	PP	105 105 1100
				WP-009	ZTL	105 105 0600
				WP-009	ZTP	105 105 0600
*33			0033T	WP-533	CL	105 105 2750
*73			0013T	WP-358	CP	105 105 4000
VW Passat						
Limousine, Variant, Automatic	ZWP-8449	08.77>03.88	0086P	WP-024	PL	105 105 0800
				WP-035	PP	105 105 1100
				WP-017	TL	105 105 0500
				WP-196	TP	105 105 1300
				WP-018	ZTL	105 105 0650
				WP-018	ZTP	105 105 0650
				WP-404	CL	105 105 2550
*74			0033T	WP-015	CP	105 105 2700
VW Passat						
Limousine	ZWP-8450	08.84>03.88	0086P	WP-024	PL	105 105 0800
				WP-035	PP	105 105 1100
				WP-018	ZTL	105 105 0650
				WP-018	ZTP	105 105 0650
*33				WP-533	CL	105 105 2750
*73			0033T	WP-534	CP	105 105 3750
VW Passat						
Wszystkie modele, bez ABS All models, without ABS Все модели, без ABS	ZWP-8451	04.88>91	0086P	WP-043	ZPL	105 105 0200
				WP-043	ZPP	105 105 0200
				WP-013	PL	105 105 0900
				WP-356	PP	105 105 1450
				WP-045	TL	105 105 0400
				WP-024	TL	105 105 0800
				WP-047	TP	105 105 1500
				WP-013	TP	105 105 0900
				WP-048	CL	105 105 2500
*66			0013T	WP-048	CP	105 105 2500
VW Passat						
Wszystkie modele, bez ABS All models, without ABS Все модели, без ABS	ZWP-8452	04.88>91	0086P	WP-043	ZPL	105 105 0200
				WP-043	ZPP	105 105 0200
				WP-013	PL	105 105 0900
				WP-356	PP	105 105 1450
				WP-045	TL	105 105 0400
				WP-018	TL	105 105 0650
				WP-047	TP	105 105 1500
				WP-024	TP	105 105 0800
				WP-048	CL	105 105 2500
*67			0013T	WP-048	CP	105 105 2500
VW Passat						
Wszystkie modele, bez ABS All models, without ABS Все модели, без ABS Nr 31-LE123871>31-LB045032	ZWP-8453	04.88>11.89	0086P	WP-043	ZPL	105 105 0200
				WP-043	ZPP	105 105 0200
				WP-013	PL	105 105 0900
				WP-047	PP	105 105 1500
				WP-045	TL	105 105 0400
				WP-024	TL	105 105 0800
				WP-047	TP	105 105 1500
				WP-013	TP	105 105 0900
				WP-001	SP	105 105 0300
*66			0013T	WP-706	ST	105 105 2450

MARKA SAMOCHODU
CAR MODEL
МОДЕЛЬ АВТОМБИЯ

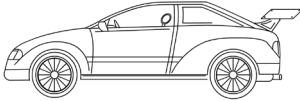

NUMER ZESTAWU
SET NUMBER
НОМЕР НАБОРА

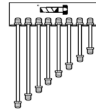

ROK PRODUKCJI
PRODUCTION YEAR
ГОД ВЫПУСКА АВТОМБИЯ



ODPOWIETRZNIK
BLEEDER SCREW
ШТУЦЕР ПРОКАЧКИ ТОРМОЗОВ

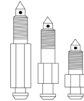

INDEKS
INDEX
ИНДЕКС



POŁOŻENIE
LOCATION
МЕСТО

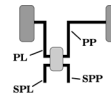

OPIS
DESCRIPTION
ОПИСАНИЕ

ZŁĄCZKA ZŁĄCZKA DŁUGOŚĆ
FITTING FITTING LENGTH
НАКОНЕЧНИК НАКОНЕЧНИК ДЛИНА

MARKA SAMOCHODU CAR MODEL МОДЕЛЬ АВТОМБИЯ	NUMER ZESTAWU SET NUMBER НОМЕР НАБОРА	ROK PRODUKCJI PRODUCTION YEAR ГОД ВЫПУСКА АВТОМБИЯ	ODPOWIETRZNIK BLEEDER SCREW ШТУЦЕР ПРОКАЧКИ ТОРМОЗОВ	INDEKS INDEX ИНДЕКС	POŁOŻENIE LOCATION МЕСТО	OPIS DESCRIPTION ОПИСАНИЕ				
VW Passat										
Wszystkie modele, z ABS All models, with ABS Все модели, с ABS Nr 31-LE123871>31-LB045032 *67	ZWP-8454	04.88>11.89	0086P	WP-043	ZPL	105 105 0200				
				WP-043	ZPP	105 105 0200				
				WP-013	PL	105 105 0900				
				WP-047	PP	105 105 1500				
				WP-045	TL	105 105 0400				
				WP-018	TL	105 105 0650				
				WP-047	TP	105 105 1500				
				WP-024	TP	105 105 0800				
				WP-006	SP	105 105 0250				
				WP-706	ST	105 105 2450				
VW Passat										
Wszystkie modele, z ABS All models, with ABS Все модели, с ABS Nr 31-LE123872>31LB045033 *66	ZWP-8455	12.89>07.91	0086P	WP-043	ZPL	105 105 0200				
				WP-043	ZPP	105 105 0200				
				WP-013	PL	105 105 0900				
				WP-047	PP	105 105 1500				
				WP-045	TL	105 105 0400				
				WP-024	TL	105 105 0800				
				WP-047	TP	105 105 1500				
				WP-013	TP	105 105 0900				
				WP-001	SP	105 105 0300				
				WP-048	ST	105 105 2500				
VW Passat										
Wszystkie modele, z ABS All models, with ABS Все модели, с ABS Nr 31LE123872>31-LB045033 *67	ZWP-8456	12.89>07.91	0086P	WP-043	ZPL	105 105 0200				
				WP-043	ZPP	105 105 0200				
				WP-013	PL	105 105 0900				
				WP-047	PP	105 105 1500				
				WP-045	TL	105 105 0400				
				WP-018	TL+	105 105 0650				
				WP-047	TP	105 105 1500				
				WP-024	TP+	105 105 0800				
				WP-006	SP	105 105 0250				
				WP-048	ST	105 105 2500				
VW Passat										
Wszystkie modele All models Все модели Nr 31NE000001, 31-NB000001>, 31-PR259865, 31-PB201227 *66 *74	ZWP-8457	08.91>10.93	0086P	WP-013	PL	105 105 0900				
				WP-356	PP	105 105 1450				
				WP-024	TL	105 105 0800				
				WP-013	TP	105 105 0900				
				WP-048	CL	105 105 2500				
				WP-048	CP	105 105 2500				
VW Passat										
Wszystkie modele All models Все модели Nr 31-NE000001, 31NB-000001>, 31PE259865, 31-PB201227 *67 *74	ZWP-8458	08.91>10.93	0086P	WP-013	PL	105 105 0900				
				WP-356	PP	105 105 1450				
				WP-018	TL	105 105 0650				
				WP-024	TP	105 105 0800				
				WP-048	CL	105 105 2500				
				WP-048	CP	105 105 2500				
VW Passat										
Wszystkie modele All models Все модели Nr 3A-RB000001>3A-VE300000 *66 *74	ZWP-8459	10.93>12.96	0086P	WP-265	PL	105 105 0950				
				WP-047	PP	105 105 1500				
				WP-024	TL	105 105 0800				
				WP-013	TP	105 105 0900				
				WP-706	CL	105 105 2450				
				WP-404	CP	105 105 2550				
VW Passat										
Wszystkie modele All models Все модели Nr 3A-RB000001>3A-VE300000 *67 *74	ZWP-8460	10.93>12.96	0019P	WP-265	PL	105 105 0950				
				WP-047	PP	105 105 1500				
				WP-018	TL	105 105 0650				
				WP-024	TP	105 105 0800				
				WP-706	CL	105 105 2450				
				WP-404	CP	105 105 2550				
				VW Passat						
				Wszystkie modele z ABS, od Nr 3B-V-000-001 All models with ABS, from no. 3B-V-000-001 Все модели с ABS, от нет. 3B-V-000-001	ZWP-84102	01.97>04.05	0039P	WP-006	ZPL	105 105 0250
WP-006	ZPP	105 105 0250								
WP-013	PL	105 105 0900								
WP-049	PP	105 105 1900								
	TL	N/A								
	TP	N/A								
WP-1691	SPL	106 106 0900								
WP-265	SPP	105 105 0950								
WP-717	STL	105 106 2300								
WP-029	STP	105 105 3200								
VW Polo										
Wszystkie modele All models Все модели *71 *73	ZWP-8406	75>08.81	0086P	WP-005	PL	105 105 0450				
				WP-003	P	105 105 1400				
				WP-001	TL	105 105 0300				
				WP-001	TP	105 105 0300				
				WP-008	CL	105 105 3000				
				WP-007	CP	105 105 3900				

MARKA SAMOCHODU
CAR MODEL
МОДЕЛЬ АВТОМБИЯ

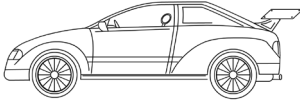

NUMER ZESTAWU
SET NUMBER
НОМЕР НАБОРА

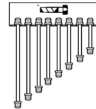

ROK PRODUKCJI
PRODUCTION YEAR
ГОД ВЫПУСКА АВТОМБИЯ



ODPOWIETRZNIK
BLEEDER SCREW
ШТУЦЕР ПРОКАЧКИ ТОРМОЗОВ

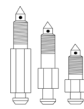

INDEKS
INDEX
ИНДЕКС



POŁOŻENIE
LOCATION
МЕСТО

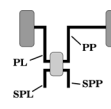

OPIS
DESCRIPTION
ОПИСАНИЕ

ZŁĄCZKA ZŁĄCZKA DŁUGOŚĆ
FITTING FITTING LENGTH
НАКОНЕЧНИК НАКОНЕЧНИК ДЛИНА

MARKA SAMOCHODU CAR MODEL МОДЕЛЬ АВТОМБИЯ	NUMER ZESTAWU SET NUMBER НОМЕР НАБОРА	ROK PRODUKCJI PRODUCTION YEAR ГОД ВЫПУСКА АВТОМБИЯ	ODPOWIETRZNIK BLEEDER SCREW ШТУЦЕР ПРОКАЧКИ ТОРМОЗОВ	INDEKS INDEX ИНДЕКС	POŁOŻENIE LOCATION МЕСТО	OPIS DESCRIPTION ОПИСАНИЕ
VW Polo						
Wszystkie modele All models Все модели *72 *73	ZWP-8407	75>08.81	0086P	WP-009	PL	105 105 0600
				WP-010	PP	105 105 1850
				WP-001	TL	105 105 0300
				WP-001	TP	105 105 0300
				WP-004	CL	105 105 3100
				WP-007	CP	105 105 3900
				VW Polo		
Wszystkie modele All models Все модели Nr 8672376929 *71 *74	ZWP-8408	11.76>08.81	0086P	WP-005	PL	105 105 0450
				WP-003	PP	105 105 1400
				WP-117	TL	105 105 0750
				WP-022	TP	105 105 1350
				WP-001	ZTL	105 105 0300
				WP-001	ZTP	105 105 0300
				WP-390	CL	105 105 2250
				WP-048	CP	105 105 2500
				VW Polo		
Wszystkie modele All models Все модели Nr 8672376929 *72 *74	ZWP-8409	11.76>08.81	0086P	WP-009	PL	105 105 0600
				WP-010	PP	105 105 1850
				WP-117	TL	105 105 0750
				WP-022	TP	105 105 1350
				WP-001	ZTL	105 105 0300
				WP-001	ZTP	105 105 0300
				WP-014	CL	105 105 2400
				WP-167	CP	105 105 2600
				VW Polo		
Wszystkie modele All models Все модели *71	ZWP-8410	09.81>07.84	0086P	WP-017	PL	105 105 0500
				WP-010	PP	105 105 1850
				WP-001	ZTL	105 105 0300
				WP-001	ZTP	105 105 0300
				WP-008	CL	105 105 3000
				WP-030	CP	105 105 3700
VW Polo						
Wszystkie modele All models Все модели *72 *74	ZWP-8466	09.81>07.84	0086P	WP-009	PL	105 105 0600
				WP-010	PP	105 105 1850
				WP-024	TL	105 105 0800
				WP-003	TP	105 105 1400
				WP-001	ZTL	105 105 0300
				WP-001	ZTP	105 105 0300
				WP-014	CL	105 105 2400
				WP-167	CP	105 105 2600
				VW Polo		
Wszystkie modele All models Все модели *72 *73	ZWP-8467	09.81>07.90	0086P	WP-009	PL	105 105 0600
				WP-010	PP	105 105 1850
				WP-001	ZTL	105 105 0300
				WP-001	ZTP	105 105 0300
				WP-004	CL	105 105 3100
				WP-571	CP	105 105 3850
VW Polo						
Wszystkie modele All models Все модели *72 *74	ZWP-8413	08.84>07.90	0086P	WP-009	PL	105 105 0600
				WP-010	PP	105 105 1850
				WP-013	TL	105 105 0900
				WP-039	TP	105 105 1550
				WP-001	ZTL	105 105 0300
				WP-001	ZTP	105 105 0300
				WP-014	CL	105 105 2400
				WP-048	CP	105 105 2500
VW Polo						
Wszystkie modele, bez ABS All models, without ABS Все модели, без ABS *72 *73	ZWP-8469	10.90>07.94	0086P	WP-028	PL	105 105 0550
				WP-435	PP	105 105 1600
				WP-001	TL	105 105 0300
				WP-001	TP	105 105 0300
				WP-008	CL	105 105 3000
				WP-534	CP	105 105 3750
VW Polo						
2-drzwi, bez ABS 2-doors, without ABS 2-двери, без ABS *66 *74	ZWP-8470	08.94>09.01	0086P	WP-028	PL	105 105 0550
				WP-035	PP	105 105 1100
				WP-017	TL	105 105 0500
				WP-009	TP	105 105 0600
				WP-015	SPL	105 105 2700
				WP-015	SPP	105 105 2700
				WP-006	STL	105 105 0250
				WP-042	STP	105 105 1700

MARKA SAMOCHODU
CAR MODEL
МОДЕЛЬ АВТОМБИЯ

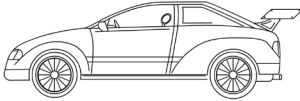

NUMER ZESTAWU
SET NUMBER
НОМЕР НАБОРА

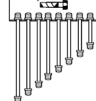

ROK PRODUKCJI
PRODUCTION YEAR
ГОД ВЫПУСКА АВТОМБИЯ



ODPOWIETRZNIK
BLEEDER SCREW
ШТУЦЕР ПРОКАЧКИ ТОРМОЗОВ

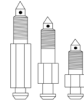

INDEKS
INDEX
ИНДЕКС



POŁOŻENIE
LOCATION
МЕСТО

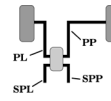

OPIS
DESCRIPTION
ОПИСАНИЕ

ZŁĄCZKA ZŁĄCZKA DŁUGOŚĆ
FITTING FITTING LENGTH
НАКОНЕЧНИК НАКОНЕЧНИК ДЛИНА

MARKA SAMOCHODU CAR MODEL МОДЕЛЬ АВТОМБИЯ	NUMER ZESTAWU SET NUMBER НОМЕР НАБОРА	ROK PRODUKCJI PRODUCTION YEAR ГОД ВЫПУСКА АВТОМБИЯ	ODPOWIETRZNIK BLEEDER SCREW ШТУЦЕР ПРОКАЧКИ ТОРМОЗОВ	INDEKS INDEX ИНДЕКС	POŁOŻENIE LOCATION МЕСТО	OPIS DESCRIPTION ОПИСАНИЕ
VW Polo						
4-drzwi, bez ABS 4-doors, without ABS 4-двери, без ABS *66 *74	ZWP-8471	11.95>09.01	0086P	WP-028	PL	105 105 0550
				WP-196	PP	105 105 1300
				WP-017	TL	105 105 0500
				WP-018	TP	105 105 0650
				WP-015	SPL	105 105 2700
				WP-533	SPP	105 105 2750
				WP-205	STL	105 105 0150
				WP-047	STP	105 105 1500
VW Polo						
2-drzwi, z ABS 2-doors, with ABS 2-двери, с ABS *66 *74	ZWP-8472	08.94>09.01	0086P	WP-264	PL	104 105 0750
				WP-022	PP	105 105 1350
				WP-017	TL	105 105 0500
				WP-009	TP	105 105 0600
				WP-585	CL	104 105 2650
				WP-358	CP	105 105 4000
VW Santana						
	ZWP-8473	83>85	0086P	WP-024	PL	105 105 0800
				WP-035	PP	105 105 1100
				WP-017	TL	105 105 0500
				WP-196	TP	105 105 1300
				WP-018	ZTL	105 105 0650
				WP-018	ZTP	105 105 0650
				WP-167	CL	105 105 2600
				WP-015	CP	105 105 2700
VW Scirocco						
Wszystkie modele All models Все модели	ZWP-8474	08.83>01.84	0086P	WP-028	PL	105 105 0550
				WP-039	PP	105 105 1550
				WP-009	ZTL	105 105 0600
				WP-009	ZTP	105 105 0600
				WP-043	SPL	105 105 0200
				WP-006	SPP	105 105 0250
				WP-404	STL	105 105 2550
				WP-030	STP	105 105 3700
VW Scirocco						
Wszystkie modele All models Все модели	ZWP-8475	02.84>90	0086P	WP-028	PL	105 105 0550
				WP-039	PP	105 105 1550
				WP-009	ZTL	105 105 0600
				WP-009	ZTP	105 105 0600
				WP-707	CL	105 105 2650
				WP-030	CP	105 105 3700
VW Sharan						
bez ABS without ABS без ABS	ZWP-8476	09.95>05.00	0086P	WP-024	PL	105 105 0800
				WP-012	PP	105 105 1650
				WP-024	TL	105 105 0800
				WP-024	TP	105 105 0800
				WP-042	SPL	105 105 1700
				WP-256	SPP	105 106 1750
				WP-023	STL	105 105 1800
				WP-023	STP	105 105 1800
VW Sharan						
z ABS with ABS с ABS Nr 7M-T-500 001 - 7M-W-020 917	ZWP-8477	09.95>06.97	0086P	WP-037	PL	105 107 0800
				WP-428	PP	105 105 2050
				WP-024	TL	105 105 0800
				WP-024	TP	105 105 0800
				WP-042	SPL	105 105 1700
				WP-256	SPP	105 106 1750
				WP-023	STL	105 105 1800
				WP-023	STP	105 105 1800
VW Sharan						
z ABS, od Nr 7M-W-020 917- with ABS, from no.7M-W-020 917- с ABS, от нет.7M-W-020 917-	ZWP-8478	01.97>		WP-309	PL	104 105 0700
				WP-266	PP	105 105 1900
				WP-024	TL	105 105 0800
				WP-024	TP	105 105 0800
				WP-587	SPL	105 105 2950
				WP-093	SPP	105 106 3000
				WP-197	STL	105 106 1750
				WP-042	STP	105 105 1700
VW Taro						
2WD	ZWP-8479	02.89>08.97	0017P	WP-578	ZPL	105 116 0300
				WP-578	ZPP	105 116 0300
				WP-002	PL	105 105 0850
				WP-001	PP	105 105 0300
				WP-839	TL	105 105X 1200
				WP-017	TP	105 105 0500
				WP-016	CL	105 105 2900
				WP-032	CP	105 105 2800

MARKA SAMOCHODU
CAR MODEL
МОДЕЛЬ АВТОМБИЯ

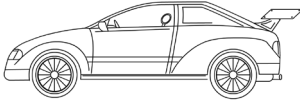

NUMER ZESTAWU
SET NUMBER
НОМЕР НАБОРА

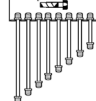

ROK PRODUKCJI
PRODUCTION YEAR
ГОД ВЫПУСКА АВТОМБИЯ



ODPOWIETRZNIK
BLEEDER SCREW
ШТУЦЕР ПРОКАЧКИ ТОРМОЗОВ

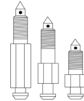

INDEKS
INDEX
ИНДЕКС



POŁOŻENIE
LOCATION
МЕСТО

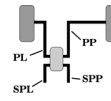

OPIS
DESCRIPTION
ОПИСАНИЕ

ZŁĄCZKA
FITTING
НАКОНЕЧНИК

ZŁĄCZKA
FITTING
НАКОНЕЧНИК

DŁUGOŚĆ
LENGTH
ДЛИНА

MARKA SAMOCHODU CAR MODEL МОДЕЛЬ АВТОМБИЯ	NUMER ZESTAWU SET NUMBER НОМЕР НАБОРА	ROK PRODUKCJI PRODUCTION YEAR ГОД ВЫПУСКА АВТОМБИЯ	ODPOWIETRZNIK BLEEDER SCREW ШТУЦЕР ПРОКАЧКИ ТОРМОЗОВ	INDEKS INDEX ИНДЕКС	POŁOŻENIE LOCATION МЕСТО	OPIS DESCRIPTION ОПИСАНИЕ
VW Taro						
2WD Pick-up	ZWP-8480	02.89>08.97	0017P	WP-578	ZPL	105 116 0300
				WP-578	ZPP	105 116 0300
				WP-002	PL	105 105 0850
				WP-001	PP	105 105 0300
				WP-839	TL	105 105X 1200
				WP-709	CL	105 105 3150
				WP-004	CP	105 105 3100
VW Taro						
4WD	ZWP-8481	02.89>08.97	0019P	WP-578	ZPL	105 116 0300
				WP-578	ZPP	105 116 0300
				WP-019	PL	105 105 1000
				WP-118	PP	116 116 0300
				WP-461	TL	105 116 1100
				WP-120	TP	116 116 0550
				WP-708	CL	105 105 2850
WP-433	CP	105 105 2950				
VW Taro						
4WD Pick-up	ZWP-8482	02.89>08.97	0019P	WP-019	PL	105 105 1000
				WP-578	PL	105 116 0300
				WP-005	PP	105 105 0450
				WP-579	PP	105 116 0400
				WP-557	TL	105 105X 1100
				WP-001	TP	105 105 0300
				WP-040	CL	105 105 3300
WP-040	CP	105 105 3300				
VW Transporter T2						
Wszystkie modele All models Все модели Nr 2132044832 *69 *72	ZWP-8483	72>07.79	0087P	WP-043	ZPL	105 105 0200
				WP-043	ZPP	105 105 0200
				WP-005	PL	105 105 0450
				WP-005	PP	105 105 0450
				WP-017	TP	105 105 0500
				WP-009	ZTL	105 105 0600
				WP-009	ZTP	105 105 0600
WP-428	CC	105 105 2050				
VW Transporter T3						
Wszystkie modele All models Все модели	ZWP-8484	08.79>07.83	0087P	WP-205	ZPL	105 105 0150
				WP-205	ZPP	105 105 0150
				WP-009	PL	105 105 0600
				WP-034	PP	105 105 1200
				WP-018	TL	105 105 0650
				WP-041	TP	105 105 0350
				WP-028	ZTL	105 105 0550
WP-028	ZTP	105 105 0550				
WP-708	CC	105 105 2850				
VW Transporter T3						
Wszystkie modele All models Все модели	ZWP-8485	08.83>07.85	0087P	WP-205	ZPL	105 105 0150
				WP-205	ZPP	105 105 0150
				WP-018	PL	105 105 0650
				WP-196	PP	105 105 1300
				WP-018	TL	105 105 0650
				WP-001	TP	105 105 0300
				WP-009	ZTL	105 105 0600
WP-009	ZTP	105 105 0600				
WP-049	SP	105 105 1900				
WP-031	ST	105 105 2200				
VW Transporter T3						
Wszystkie modele, bez ABS All models, without ABS Все модели, без ABS Nr 24G-000001>24N-015000	ZWP-8486	08.85>07.92	0087P	WP-001	ZL	105 105 0300
				WP-001	ZPP	105 105 0300
				WP-205	PL	105 105 0150
				WP-019	PP	105 105 1000
				WP-018	TL	105 105 0650
				WP-001	TP	105 105 0300
				WP-009	ZTL	105 105 0600
WP-009	ZTP	105 105 0600				
WP-571	CC	105 105 3850				
VW Transporter T4						
Wszystkie modele, bez ABS, rozstaw osi 2920 mm All models, without ABS, wheel base 2920 mm Все модели, без ABS, колесная база 2920 мм Nr 70-SH200000>70-SX140000	ZWP-8487	09.90>07.95	0039P	WP-705	ZPL	105 105 0100
				WP-705	ZPP	105 105 0100
				WP-482	PL	105 105 1950
				WP-390	PP	105 105 2250
				WP-115	TL	105 105 1150
				WP-115	TP	105 105 1150
				WP-559	SPL	105 105 2350
WP-011	SPP	105 105 2300				
WP-042	STL	105 105 1700				
WP-042	STP	105 105 1700				

MARKA SAMOCHODU
CAR MODEL
МОДЕЛЬ АВТОМБИЯ

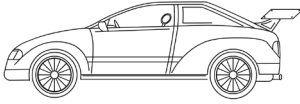

NUMER ZESTAWU
SET NUMBER
НОМЕР НАБОРА

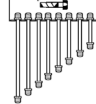

ROK PRODUKCJI
PRODUCTION YEAR
ГОД ВЫПУСКА АВТОМБИЯ



ODPOWIETRZNIK
BLEEDER SCREW
ШТУЦЕР ПРОКАЧКИ ТОРМОЗОВ

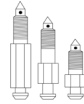

INDEKS
INDEX
ИНДЕКС



POŁOŻENIE
LOCATION
МЕСТО

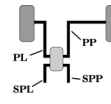

OPIS
DESCRIPTION
ОПИСАНИЕ

ZŁĄCZKA
FITTING
НАКОНЕЧНИК

ZŁĄCZKA
FITTING
НАКОНЕЧНИК

DŁUGOŚĆ
LENGTH
ДЛИНА

MARKA SAMOCHODU CAR MODEL МОДЕЛЬ АВТОМБИЯ	NUMER ZESTAWU SET NUMBER НОМЕР НАБОРА	ROK PRODUKCJI PRODUCTION YEAR ГОД ВЫПУСКА АВТОМБИЯ	ODPOWIETRZNIK BLEEDER SCREW ШТУЦЕР ПРОКАЧКИ ТОРМОЗОВ	INDEKS INDEX ИНДЕКС	POŁOŻENIE LOCATION МЕСТО	OPIS DESCRIPTION ОПИСАНИЕ
VW Transporter T4						
Wszystkie modele, bez ABS, rozstaw osi 3320 mm All models, without ABS, wheel base 3320 mm Все модели, без ABS, колесная база 3320 мм Nr 70-SH200000>70-SX140000	ZWP-8488	09.90>07.95	0039P	WP-705	ZPL	105 105 0100
				WP-705	ZPP	105 105 0100
				WP-482	PL	105 105 1950
				WP-390	PP	105 105 2250
				WP-115	TL	105 105 1150
				WP-115	TP	105 105 1150
				WP-559	SPL	105 105 2350
				WP-011	SPP	105 105 2300
				WP-036	STL	105 105 2100
				WP-036	STP	105 105 2100
VW Transporter T4						
Wszystkie modele, z ABS, rozstaw osi 2920 mm All models, with ABS, wheel base 2920 mm Все модели, с ABS, колесная база 2920 мм Nr 70-SH200000>7-SX140000	ZWP-8489	09.90>07.95	0039P	WP-705	ZPL	105 105 0100
				WP-705	ZPP	105 105 0100
				WP-049	PL	105 105 1900
				WP-011	PP	105 105 2300
				WP-115	TL	105 105 1150
				WP-115	TP	105 105 1150
				WP-559	SPL	105 105 2350
				WP-011	SPP	105 105 2300
				WP-042	STL	105 105 1700
				WP-042	STP	105 105 1700
VW Transporter T4						
Wszystkie modele, z ABS, rozstaw osi 3320 mm All models, with ABS, wheel base 3320 mm Все модели, с ABS, колесная база 3320 мм Nr 70-SH200000>70-SX140000	ZWP-8490	09.90>07.95	0039P	WP-705	ZPL	105 105 0100
				WP-705	ZPP	105 105 0100
				WP-049	PL	105 105 1900
				WP-011	PP	105 105 2300
				WP-115	TL	105 105 1150
				WP-115	TP	105 105 1150
				WP-559	SPL	105 105 2350
				WP-011	SPP	105 105 2300
				WP-036	STL	105 105 2100
				WP-036	STP	105 105 2100
VW Transporter T4						
bez ABS without ABS без ABS Nr 70-TH200001	ZWP-8491	01.96>03.03	0039P	WP-705	ZPL	105 105 0100
				WP-705	ZPP	105 105 0100
				WP-428	PL	105 105 2050
				WP-011	PP	105 105 2300
				WP-117	TL	105 105 0750
				WP-117	TP	105 105 0750
				WP-559	SPL	105 105 2350
				WP-014	SPP	105 105 2400
				WP-042	STL	105 105 1700
				WP-042	STP	105 105 1700
VW Transporter T4						
z ABS, rozstaw osi 2920 mm with ABS, wheel base 2920 mm с ABS, колесная база 2920 mm	ZWP-8492	01.96>03.03	0039P	WP-705	ZPL	105 105 0100
				WP-705	ZPP	105 105 0100
				WP-023	PL	105 105 1800
				WP-390	PP	105 105 2250
				WP-117	TL	105 105 0750
				WP-117	TP	105 105 0750
				WP-440	SPL	105 105 2150
				WP-390	SPP	105 105 2250
				WP-042	STL	105 105 1700
				WP-042	STP	105 105 1700
VW Transporter T4						
z ABS, rozstaw osi 3320 mm with ABS, wheel base 3320 mm с ABS, колесная база 3320 mm	ZWP-8493	01.96>03.03	0039P	WP-705	ZPL	105 105 0100
				WP-705	ZPP	105 105 0100
				WP-023	PL	105 105 1800
				WP-390	PP	105 105 2250
				WP-117	TL	105 105 0750
				WP-117	TP	105 105 0750
				WP-440	SPL	105 105 2150
				WP-390	SPP	105 105 2250
				WP-036	STL	105 105 2100
				WP-428	STP	105 105 2050
VW Vento						
Wszystkie modele, bez ABS All models, without ABS Все модели, без ABS *66 *73	ZWP-8427	11.91>07.97	0086P	WP-005	PL	105 105 0450
				WP-022	PP	105 105 1350
				WP-024	TL	105 105 0800
				WP-013	TP	105 105 0900
				WP-707	CL	105 105 2650
				WP-534	CP	105 105 3750
VW Vento						
Wszystkie modele, bez ABS All models, without ABS Все модели, без ABS Nr 1H-N-000001 *66 *74	ZWP-8428	11.91>07.97	0086P	WP-005	PL	105 105 0450
				WP-022	PP	105 105 1350
				WP-024	TL	105 105 0800
				WP-013	TP	105 105 0900
				WP-707	CL	105 105 2650
				WP-533	CP	105 105 2750

MARKA SAMOCHODU
CAR MODEL
МОДЕЛЬ АВТОМБИЯ

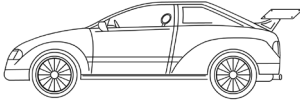

NUMER ZESTAWU
SET NUMBER
НОМЕР НАБОРА

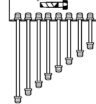

ROK PRODUKCJI
PRODUCTION YEAR
ГОД ВЫПУСКА АВТОМБИЯ



ODPOWIETRZNIK
BLEEDER SCREW
ШТУЦЕР ПРОКАЧКИ ТОРМОЗОВ

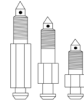

INDEKS
INDEX
ИНДЕКС



POŁOŻENIE
LOCATION
МЕСТО

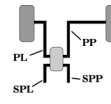

OPIS
DESCRIPTION
ОПИСАНИЕ

ZŁĄCZKA
FITTING
НАКОНЕЧНИК

ZŁĄCZKA
FITTING
НАКОНЕЧНИК

DŁUGOŚĆ
LENGTH
ДИЛИНА

MARKA SAMOCHODU CAR MODEL МОДЕЛЬ АВТОМБИЯ	NUMER ZESTAWU SET NUMBER НОМЕР НАБОРА	ROK PRODUKCJI PRODUCTION YEAR ГОД ВЫПУСКА АВТОМБИЯ	ODPOWIETRZNIK BLEEDER SCREW ШТУЦЕР ПРОКАЧКИ ТОРМОЗОВ	INDEKS INDEX ИНДЕКС	POŁOŻENIE LOCATION МЕСТО	OPIS DESCRIPTION ОПИСАНИЕ
VW Vento						
Wszystkie modele, bez ABS All models, without ABS Все модели, без ABS	ZWP-8429	11.91>07.97	0086P	WP-005	PL	105 105 0450
				WP-022	PP	105 105 1350
				WP-018	TL	105 105 0650
				WP-024	TP	105 105 0800
				WP-707	CL	105 105 2650
				WP-533	CP	105 105 2750
*67			0019T			
*74			0013T			
Wartburg 353 W						
Sedan, Tourist, Pick-up	ZWP-8501	74>89	0100P	WP-041	PL	105 105 0350
				WP-041	PL	105 105 0350
				WP-002	PP	105 105 0850
				WP-002	PP	105 105 0850
				WP-018	TL	105 105 0650
				WP-018	TL	105 105 0650
WP-004	CC	105 105 3100				
Wartburg						
	ZWP-8502		0100P	WP-029	CC	105 105 3200
				WP-117	PP ROZ I OBW	105 105 0750
				WP-001	PL ROZ II OBW	105 105 0300
				WP-018	TL	105 105 0650
				WP-018	TP	105 105 0650
				WP-028	POM-ROZ I OBW	105 105 0550
				WP-017	POM-ROZ II OBW	105 105 0500
				WP-045	KOR-TRÓJ	105 105 0400
				WP-006	PL I OBW	105 105 0250
				WP-117	PP II OBW	105 105 0750
Zastawa Yugo						
45	ZWP-8601	83>90	0100P	WP-153	PL	112 112 0650
				WP-052	PP	112 112 1050
				WP-411	TL	112 112 0800
				WP-150	TP	112 112 0400
				WP-789	CC	112 112 2800
			0100T			
Zastawa Yugo						
45	ZWP-8602	91>	0100P	WP-730	PL	105 112 0600
				WP-733	PP	105 112 1350
				WP-411	TL	112 112 0800
				WP-411	TP	112 112 0800
				WP-415	SPL	105 112 0200
				WP-394	SPP	105 112 0550
				WP-149	STL	112 112 1100
				WP-420	STP	105 112 2000
Zastawa Yugo						
511	ZWP-8603	81>90	0100P	WP-150	PL	112 112 0400
				WP-163	PP	112 112 1450
				WP-162	TL	112 112 0450
				WP-152	TP	112 112 1250
				WP-154	SP	112 112 0950
				WP-161	ST	112 112 2400
			0100T			
Žuk						
	ZWP-8701			WP-471	CC	105 109 1900
				WP-482	PP	105 105 1950
				WP-117	PL	105 105 0750
				WP-034	TP	105 105 1200
				WP-009	TL	105 105 0600
				WP-473	POM-SYG D	105 109 0250
				WP-472	POM-SYG K	105 109 0200
				WP-053	ZPP	112 112 0500
				WP-053	ZPL	112 112 0500
				WP-474	SYG-KOS	105 109 0300

Zestawy przewodów hamulcowych

Brake lines sets

Наборы тормозных трубок

Citroen BX bez / without / без ABS

Przewody hamulcowe / Brake lines / Тормозные трубки

Zestaw do 89' / Set to 89' / Набор до 89'

ZWP-5324

INDEKS INDEX ИНДЕКС	ŚREDNICA DIAMETER ДИАМЕТР	DŁUGOŚĆ W MM LENGHT IN MM ДЛИНА В MM
WP-1970	Ø3,50	0425
WP-1971	Ø3,50	0630
WP-1972	Ø3,50	3050
WP-1973	Ø3,50	0505
WP-1974	Ø3,50	1110
WP-1975	Ø3,50	1800
WP-1976	Ø3,50	2200
WP-1979	Ø3,50	3420

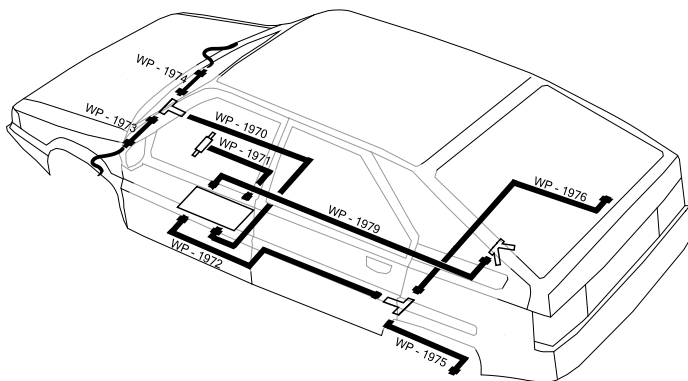

Zestaw od 89' / Set from 89' / Набор от 89'

ZWP-5324C

INDEKS INDEX ИНДЕКС	ŚREDNICA DIAMETER ДИАМЕТР	DŁUGOŚĆ W MM LENGHT IN MM ДЛИНА В MM
WP-1970	Ø3,50	0425
WP-1971	Ø3,50	0630
WP-1972	Ø3,50	3050
WP-1973	Ø3,50	0505
WP-1974	Ø3,50	1110
WP-1975	Ø3,50	1800
WP-1976	Ø3,50	2200
WP-1979C	Ø3,50	3100

ODPOWIETRZNIK / BLEEDER SCREW / ШТУЦЕР ПРОКАЧКИ ТОРМОЗОВ

PRZÓD / FRONT / ФРОНТ: **0086**

TYŁ / REAR / ЗАД: **0086**

Przewody hydrauliczne / Hydraulic lines / Гидравлические трубки

Zestaw / Set / Набор

ZWP-5327

INDEKS INDEX ИНДЕКС	ŚREDNICA DIAMETER ДИАМЕТР	DŁUGOŚĆ W MM LENGHT IN MM ДЛИНА В MM
WP-1980	Ø3,50	0945
WP-1981	Ø3,50	0460
WP-1982	Ø3,50	3205
WP-1983	Ø3,50	1955
WP-1984	Ø3,50	1385
WP-1985	Ø3,50	0750
WP-1986	Ø3,50	0865
WP-1987	Ø3,50	0330
WP-1989	Ø3,50	3785

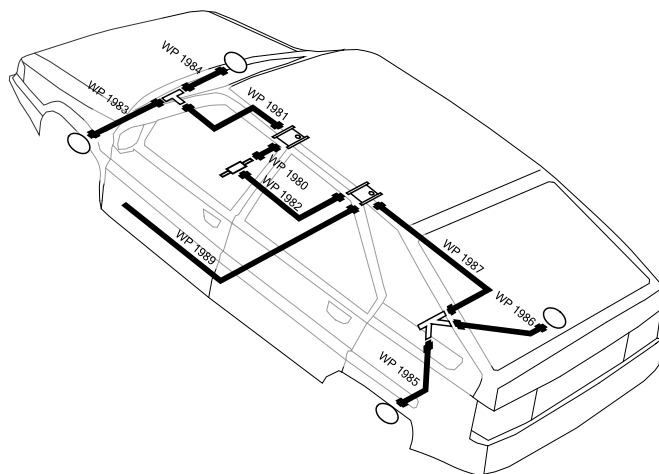

Citroen BX z / with / с ABS

Przewody hamulcowe / Brake lines / Тормозные трубки

Zestaw od 10.1988 do 01.1991

Set from 10.1988 to 01.1991

Набор от 10.1988 до 01.1991

ZWP-5326

INDEKS INDEX ИНДЕКС	ŚREDNICA DIAMETER ДИАМЕТР	DŁUGOŚĆ W MM LENGHT IN MM ДЛИНА В MM
WP-1975	Ø3,50	1800
WP-1976	Ø3,50	2200
WP-1979	Ø3,50	3420
WP-1990	Ø3,50	0425
WP-1991	Ø3,50	0360
WP-1992	Ø4,50	3320
WP-1993	Ø4,50	0820
WP-1994	Ø4,50	1665
WP-1998	Ø3,50	0830
WP-1998C	Ø3,50	0830
WP-1998D	Ø4,50	0775
WP-1998E	Ø4,50	0750
WP-1998F	Ø4,50	0750

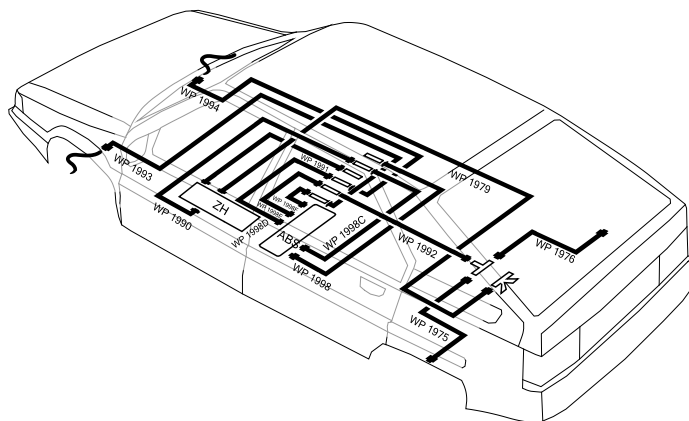

ODPOWIETRZNIK / BLEEDER SCREW / ШТУЦЕР ПРОКАЧКИ ТОРМОЗОВ

PRZÓD / FRONT / ФРОНТ: **0053**

TYŁ / REAR / ЗАД: **0092**

Przewody hydrauliczne / Hydraulic lines / Гидравлические трубки

Zestaw / Set / Набор

ZWP-5325

INDEKS INDEX ИНДЕКС	ŚREDNICA DIAMETER ДИАМЕТР	DŁUGOŚĆ W MM LENGHT IN MM ДЛИНА В MM
WP-1980	Ø3,50	0945
WP-1981	Ø3,50	0460
WP-1982	Ø3,50	3205
WP-1983	Ø3,50	1955
WP-1984	Ø3,50	1385
WP-1985	Ø3,50	0750
WP-1986	Ø3,50	0865
WP-1987	Ø3,50	0330
WP-1989	Ø3,50	3785

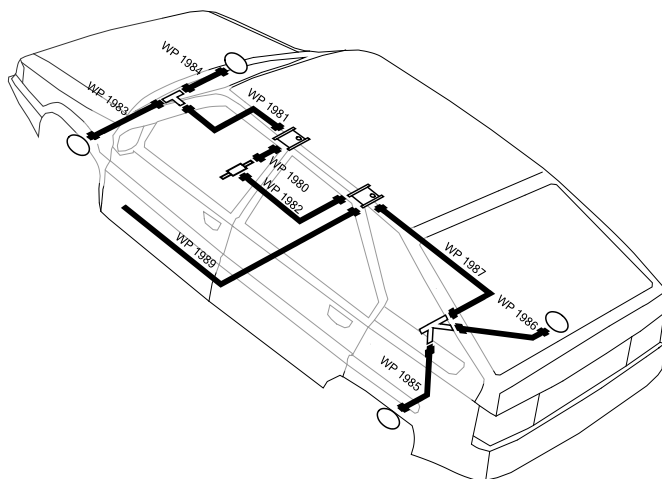

Citroen XANTIA

Przewody hamulcowe / Brake lines / Тормозные трубки

Zestaw / Set / Набор

ZWP-5332

INDEKS INDEX ИНДЕКС	ŚREDNICA DIAMETER ДИАМЕТР	DŁUGOŚĆ W MM LENGHT IN MM ДЛИНА В ММ
WP-2970	Ø3,50	0335
WP-2971	Ø3,50	0792
WP-2971A	Ø3,50	0391
WP-2973	Ø4,75	0786
WP-2974	Ø4,75	1578
WP-2975	Ø3,50	1938
WP-2976	Ø3,50	2462
WP-2977	Ø3,50	0586
WP-2979	Ø3,50	3985
WP-2992	Ø4,50	3307

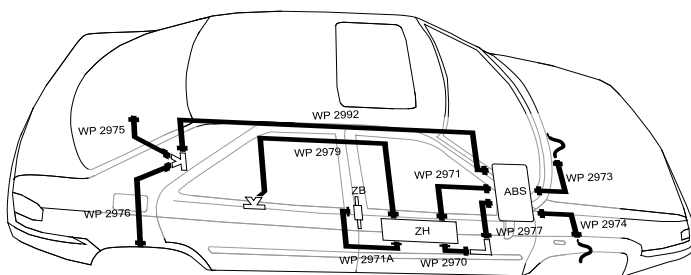

ODPOWIETRZNIK / BLEEDER SCREW / ШТУЦЕР ПРОКАЧКИ ТОРМОЗОВ

PRZÓD / FRONT / ФРОНТ: **0069**

TYŁ / REAR / ЗАД: **0092**

Przewody hydrauliczne / Hydraulic lines / Гидравлические трубки

Zestaw / Set / Набор

ZWP-5333

INDEKS INDEX ИНДЕКС	ŚREDNICA DIAMETER ДИАМЕТР	DŁUGOŚĆ W MM LENGHT IN MM ДЛИНА В ММ
WP-2980	Ø3,50	0568
WP-2981	Ø3,50	0925
WP-2981A	Ø3,50	1147
WP-2981B	Ø3,50	1006
WP-2982	Ø3,50	3690
WP-2983	Ø3,50	1020
WP-2984	Ø3,50	2201
WP-2985	Ø3,50	0951
WP-2986	Ø3,50	1085
WP-2987	Ø3,50	0339
WP-2988	Ø3,50	0440
WP-2988A	Ø3,50	0271
WP-2988B	Ø3,50	0201
WP-2989	Ø3,50	3763
WP-2990	Ø3,50	0541

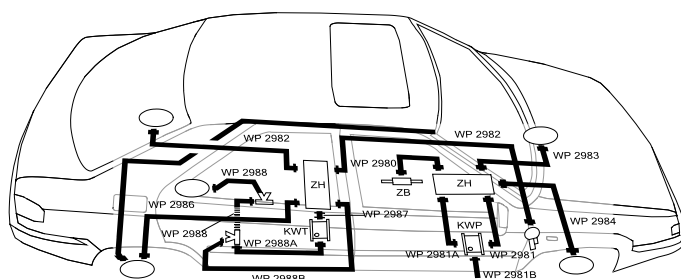

Citroen 2CV

Przewody hamulcowe / Brake lines / Тормозные трубки

Zestaw / Set / Набор

ZWP-5330

HAMULCE BĘBNOWE / DRUM BRAKES / ТОРМОЗА БАРАБАНЫЕ

INDEKS INDEX ИНДЕКС	ŚREDNICA DIAMETER ДИАМЕТР	DŁUGOŚĆ W MM LENGHT IN MM ДЛИНА В MM
WP-1901	Ø3,50	1500
WP-1902	Ø3,50	2450
WP-1903	Ø3,50	0240
WP-1904	Ø3,50	0230
WP-1905	Ø3,50	2570
WP-1906	Ø3,50	2530
WP-1907	Ø3,50	0440

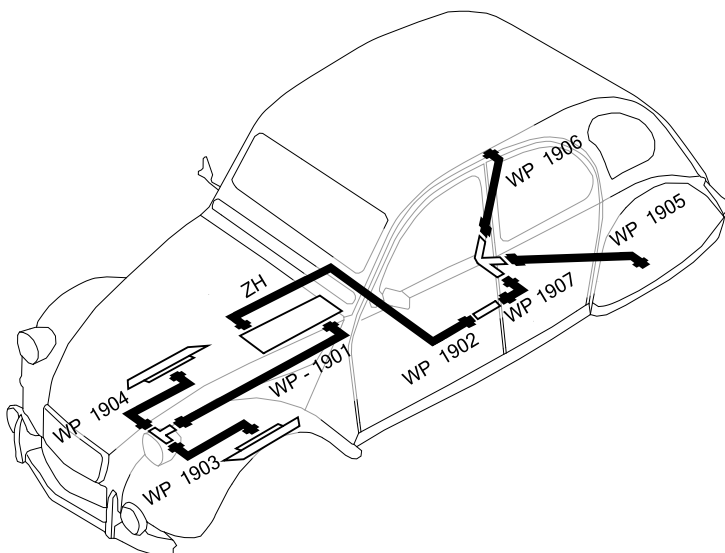

Zestaw / Set / Набор

ZWP-5331

HAMULCE TARCZOWE / DISC BRAKES / ТОРМОЗА ДИСКОВЫЕ БАРАБАНЫЕ

INDEKS INDEX ИНДЕКС	ŚREDNICA DIAMETER ДИАМЕТР	DŁUGOŚĆ W MM LENGHT IN MM ДЛИНА В MM
WP-1902	Ø3,50	2450
WP-1905	Ø3,50	2570
WP-1906	Ø3,50	2530
WP-1907	Ø3,50	0440
WP-1911	Ø3,50	1600
WP-1913	Ø3,50	0345

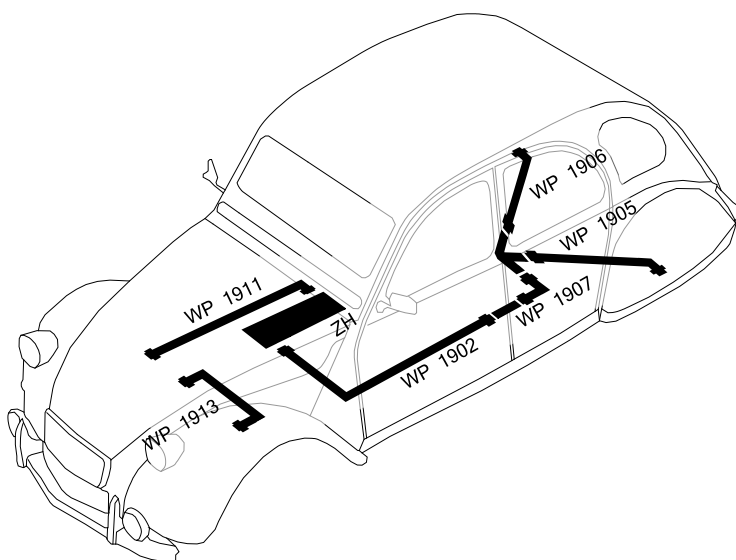

ODPWIETRZNIK / BLEEDER SCREW / ШТУЦЕР ПРОКАЧКИ ТОРМОЗОВ

PRZÓD / FRONT / ФРОНТ: **0053, 0039**

TYŁ / REAR / ЗАД: **0053**

Citroen CX

Przewody hamulcowe / Brake lines / Тормозные трубки

Zestaw / Set / Набор

ZWP-5328

INDEKS INDEX ИНДЕКС	ŚREDNICA DIAMETER ДИАМЕТР	DŁUGOŚĆ W MM LENGHT IN MM ДЛИНА В MM
WP-1832	Ø3,50	2635
WP-1833	Ø3,50	0510
WP-1834C	Ø3,50	1100
WP-1835Y	Ø3,50	1960
WP-1836	Ø3,50	1085
WP-1836Y	Ø3,50	1980
WP-1839	Ø3,50	3185

Zestaw / Set / Набор

ZWP-5328C - COMBI

INDEKS INDEX ИНДЕКС	ŚREDNICA DIAMETER ДИАМЕТР	DŁUGOŚĆ W MM LENGHT IN MM ДЛИНА В MM
WP-1832	Ø3,50	2635
WP-1833	Ø3,50	0510
WP-1834C	Ø3,50	1100
WP-1835Y	Ø3,50	1960
WP-1836	Ø3,50	1085
WP-1836Y	Ø3,50	1980
WP-1839	Ø3,50	3185

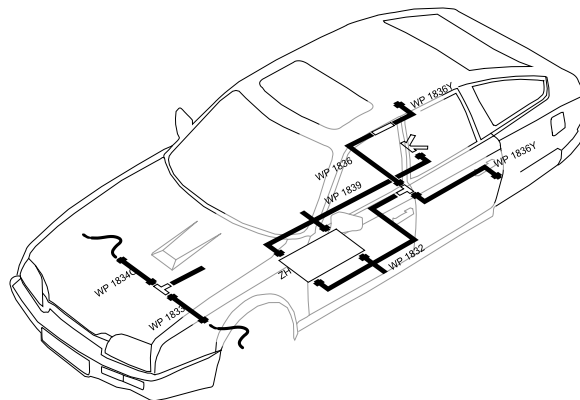

ODPOWIETRZNIK / BLEEDER SCREW / ШТУЦЕР ПРОКАЧКИ ТОРМОЗОВ

PRZÓD / FRONT / ФРОНТ: **0053**

TYŁ / REAR / ЗАД: **0092**

Przewody hydrauliczne / Hydraulic lines / Гидравлические трубки

Zestaw / Set / Набор

ZWP-5329

INDEKS INDEX ИНДЕКС	ŚREDNICA DIAMETER ДИАМЕТР	DŁUGOŚĆ W MM LENGHT IN MM ДЛИНА В MM
WP-1842	Ø3,50	2970
WP-1845	Ø3,50	0940
WP-1846	Ø3,50	0595
WP-1847	Ø3,50	0310
WP-1849	Ø3,50	2820

Zestaw / Set / Набор

ZWP-5329C - COMBI

INDEKS INDEX ИНДЕКС	ŚREDNICA DIAMETER ДИАМЕТР	DŁUGOŚĆ W MM LENGHT IN MM ДЛИНА В MM
WP-1842a	Ø3,50	3300
WP-1845	Ø3,50	0940
WP-1846	Ø3,50	0595
WP-1847	Ø3,50	0310
WP-1849	Ø3,50	2820

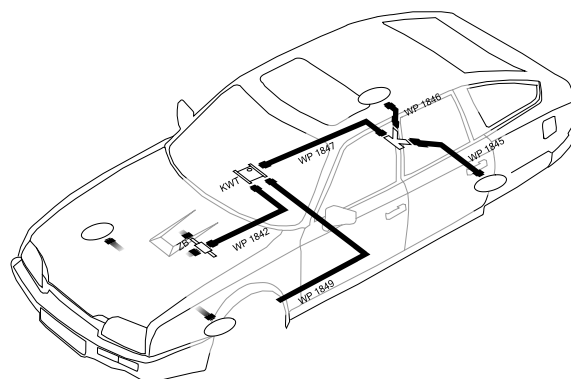

PRZEWODY AKUMULATOROWE / ACCUMULATION BRAKES / КАБЕЛЬ АККУМУЛЯТОРНЫЙ

WP-1830	Ø4,50	1045
WP-1831	Ø3,50	0955
WP-1838	Ø3,50	0465

Do samochodów niemieckich

For german cars / Для немецких автомобилей

Index: **ZESTAW1**

INDEKS INDEX ИНДЕКС	ZŁĄCZKA FITTING НАКОНЕЧНИК	ZŁĄCZKA FITTING НАКОНЕЧНИК	DŁUGOŚĆ W MM LENGHT IN MM ДЛИНА В ММ	ILOŚĆ QUANTITY КОЛИЧЕСТВО
WP-205	105	105	150	5 szt/pcs/шт.
WP-043	105	105	200	5 szt/pcs/шт.
WP-006	105	105	250	5 szt/pcs/шт.
WP-001	105	105	300	5 szt/pcs/шт.
WP-041	105	105	350	5 szt/pcs/шт.
WP-045	105	105	400	5 szt/pcs/шт.
WP-005	105	105	450	5 szt/pcs/шт.
WP-017	105	105	500	5 szt/pcs/шт.
WP-028	105	105	550	5 szt/pcs/шт.
WP-009	105	105	600	5 szt/pcs/шт.
WP-018	105	105	650	5 szt/pcs/шт.
WP-033	105	105	700	5 szt/pcs/шт.
WP-117	105	105	750	5 szt/pcs/шт.
WP-024	105	105	800	5 szt/pcs/шт.
WP-002	105	105	850	5 szt/pcs/шт.
WP-013	105	105	900	5 szt/pcs/шт.
WP-265	105	105	950	5 szt/pcs/шт.
WP-019	105	105	1000	5 szt/pcs/шт.
WP-035	105	105	1100	5 szt/pcs/шт.
WP-034	105	105	1200	5 szt/pcs/шт.
WP-196	105	105	1300	5 szt/pcs/шт.
WP-003	105	105	1400	5 szt/pcs/шт.
WP-047	105	105	1500	5 szt/pcs/шт.

ŁĄCZNIK CONNECTOR ПЕРЕХОДНИК	5-600-121	10/1 - 10/1	5 szt/ pcs/шт.
ŁĄCZNIK CONNECTOR ПЕРЕХОДНИК	5-600-123	10/1 - 10/1,25	5 szt/ pcs/шт.
ŁĄCZNIK CONNECTOR ПЕРЕХОДНИК	5-600-131	10/1 - 12/1	5 szt/ pcs/шт.
REDUKCJA REDUCTOR РЕДУКТОР	5-600-129	10/1 - 12/1	5 szt/ pcs/шт.
WIESZAK HANGER ВЕШАЛКА	5-700		1 szt/ pcs/шт.



Do samochodów francuskich

For french cars / Для французских автомобилей

Index: **ZESTAW2**

INDEKS INDEX ИНДЕКС	ZŁĄCZKA FITTING НАКОНЕЧНИК	ZŁĄCZKA FITTING НАКОНЕЧНИК	DŁUGOŚĆ W MM LENGHT IN MM ДЛИНА В ММ	ILOŚĆ QUANTITY КОЛИЧЕСТВО
WP-453	104	105	250	5 szt/pcs/шт.
WP-457	104	105	400	5 szt/pcs/шт.
WP-441	104	105	500	5 szt/pcs/шт.
WP-283	104	105	550	5 szt/pcs/шт.
WP-499	104	105	650	5 szt/pcs/шт.
WP-043	105	105	200	5 szt/pcs/шт.
WP-041	105	105	350	5 szt/pcs/шт.
WP-045	105	105	400	5 szt/pcs/шт.
WP-005	105	105	450	5 szt/pcs/шт.
WP-017	105	105	500	5 szt/pcs/шт.
WP-028	105	105	550	5 szt/pcs/шт.
WP-009	105	105	600	5 szt/pcs/шт.
WP-018	105	105	650	5 szt/pcs/шт.
WP-024	105	105	800	5 szt/pcs/шт.
WP-013	105	105	800	5 szt/pcs/шт.
WP-019	105	105	1000	5 szt/pcs/шт.
WP-286	109	109	150	5 szt/pcs/шт.
WP-287	109	109	600	5 szt/pcs/шт.
WP-296	109	109	700	5 szt/pcs/шт.
WP-057	109	109	1100	5 szt/pcs/шт.
WP-269	115	115	400	5 szt/pcs/шт.
WP-273	115	115	600	5 szt/pcs/шт.
WP-267	115	115	900	5 szt/pcs/шт.

ŁĄCZNIK CONNECTOR ПЕРЕХОДНИК	5-600-121	10/1 - 10/1	5 szt/ pcs/шт.
ŁĄCZNIK CONNECTOR ПЕРЕХОДНИК	5-600-123	10/1 - 10/1,25	5 szt/ pcs/шт.
ŁĄCZNIK CONNECTOR ПЕРЕХОДНИК	5-600-131	10/1 - 12/1	5 szt/ pcs/шт.
REDUKCJA REDUCTOR РЕДУКТОР	5-600-129	10/1 - 12/1	5 szt/ pcs/шт.
WIESZAK HANGER ВЕШАЛКА	5-700		1 szt/ pcs/шт.



Do samochodów włoskich

For italian cars / Для итальянских автомобилей

Index: **ZESTAW3**

INDEKS INDEX ИНДЕКС	ZŁĄCZKA FITTING НАКОНЕЧНИК	ZŁĄCZKA FITTING НАКОНЕЧНИК	DŁUGOŚĆ W MM LENGHT IN MM ДЛИНА В ММ	ILOŚĆ QUANTITY КОЛИЧЕСТВО
WP-045	105	105	400	5 szt/pcs/шт.
WP-005	105	105	450	5 szt/pcs/шт.
WP-017	105	105	500	5 szt/pcs/шт.
WP-028	105	105	550	5 szt/pcs/шт.
WP-009	105	105	600	5 szt/pcs/шт.
WP-018	105	105	650	5 szt/pcs/шт.
WP-024	105	105	800	5 szt/pcs/шт.
WP-013	105	105	900	5 szt/pcs/шт.
WP-019	105	105	1000	5 szt/pcs/шт.
WP-034	105	105	1200	5 szt/pcs/шт.
WP-027	105	105	1250	5 szt/pcs/шт.
WP-196	105	105	1300	5 szt/pcs/шт.
WP-022	105	105	1350	5 szt/pcs/шт.
WP-056	112	112	300	5 szt/pcs/шт.
WP-151	112	112	350	5 szt/pcs/шт.
WP-150	112	112	400	5 szt/pcs/шт.
WP-162	112	112	450	5 szt/pcs/шт.
WP-053	112	112	500	5 szt/pcs/шт.
WP-153	112	112	650	5 szt/pcs/шт.
WP-054	112	112	900	5 szt/pcs/шт.
WP-160	112	112	1150	5 szt/pcs/шт.
WP-152	112	112	1250	5 szt/pcs/шт.
WP-523	104X	105	1000	5 szt/pcs/шт.

ŁĄCZNIK CONNECTOR ПЕРЕХОДНИК	5-600-121	10/1 - 10/1	5 szt/ pcs/шт.
ŁĄCZNIK CONNECTOR ПЕРЕХОДНИК	5-600-123	10/1 - 10/1,25	5 szt/ pcs/шт.
ŁĄCZNIK CONNECTOR ПЕРЕХОДНИК	5-600-131	10/1 - 12/1	5 szt/ pcs/шт.
REDUKCJA REDUCTOR РЕДУКТОР	5-600-129	10/1 - 12/1	5 szt/ pcs/шт.
WIESZAK HANGER ВЕШАЛКА	5-700		1 szt/ pcs/шт.



Do samochodów japońskich

For japan cars / Для японских автомобилей

Index: **ZESTAW4**

INDEKS INDEX ИНДЕКС	ZŁĄCZKA FITTING НАКОНЕЧНИК	ZŁĄCZKA FITTING НАКОНЕЧНИК	DŁUGOŚĆ W MM LENGHT IN MM ДЛИНА В ММ	ILOŚĆ QUANTITY КОЛИЧЕСТВО
WP-578	105	116	300	5 szt/pcs/шт.
WP-354	105	116	350	5 szt/pcs/шт.
WP-579	105	116	400	5 szt/pcs/шт.
WP-353	105	116	950	5 szt/pcs/шт.
WP-461	105	116	1100	5 szt/pcs/шт.
WP-355	105	116	1150	5 szt/pcs/шт.
WP-580	105	116	1300	5 szt/pcs/шт.
WP-130	116	116	250	5 szt/pcs/шт.
WP-118	116	116	300	5 szt/pcs/шт.
WP-138	116	116	350	5 szt/pcs/шт.
WP-144	116	116	400	5 szt/pcs/шт.
WP-134	116	116	500	5 szt/pcs/шт.
WP-141	116	116	600	5 szt/pcs/шт.
WP-131	116	116	700	5 szt/pcs/шт.
WP-136	116	116	850	5 szt/pcs/шт.
WP-126	116	116	900	5 szt/pcs/шт.
WP-429	116	116	1000	5 szt/pcs/шт.
WP-132	116	116	1050	5 szt/pcs/шт.
WP-133	116	116	1100	5 szt/pcs/шт.
WP-129	116	116	1200	5 szt/pcs/шт.
WP-124	116	116	13500	5 szt/pcs/шт.
WP-581	116	116	1400	5 szt/pcs/шт.
WP-140	116	116	1500	5 szt/pcs/шт.

ŁĄCZNIK CONNECTOR ПЕРЕХОДНИК	5-600-121	10/1 - 10/1	5 szt/ pcs/шт.
ŁĄCZNIK CONNECTOR ПЕРЕХОДНИК	5-600-123	10/1 - 10/1,25	5 szt/ pcs/шт.
ŁĄCZNIK CONNECTOR ПЕРЕХОДНИК	5-600-131	10/1 - 12/1	5 szt/ pcs/шт.
REDUKCJA REDUCTOR РЕДУКТОР	5-600-129	10/1 - 12/1	5 szt/ pcs/шт.
WIESZAK HANGER ВЕШАЛКА	5-700		1 szt/ pcs/шт.



Rurka hamulcowa w zwojach

Brake tube in coils

Тормозная трубка в бухтах

Rura Miedziana Cu

Copper tube Cu / Медная труба

INDEX INDEX ИНДЕКС	DŁUGOŚĆ LENGHT ДЛИНА	ŚREDNICA RURY DIAMETER ДИАМЕТР ТРУБЫ	GRUBOŚĆ ŚCIANKI WALL THICKNESS ТОЛЩИНА СТЕНКИ	INDEX INDEX ИНДЕКС	DŁUGOŚĆ LENGHT ДЛИНА	ŚREDNICA RURY DIAMETER ДИАМЕТР ТРУБЫ	GRUBOŚĆ ŚCIANKI WALL THICKNESS ТОЛЩИНА СТЕНКИ
1-3.50-5	5,00 m	3,50 mm	0,90 mm	1-6.00-5	5,00 m	6,00 mm	0,80 mm
1-3.50-7.62	7,62 m			1-6.00-7.62	7,62 m		
1-3.50-10	10,00 m			1-6.00-10	10,00 m		
1-3.50-15	15,00 m			1-6.00-15	15,00 m		
1-3.50-20	20,00 m			1-6.00-20	20,00 m		
1-3.50-25	25,00 m			1-6.00-25	25,00 m		
1-3.50-30	30,00 m			1-6.00-30	30,00 m		
1-3.50-40	40,00 m			1-6.00-40	40,00 m		
1-3.50-50	50,00 m			1-6.00-50	50,00 m		
1-4.50-5	5,00 m			4,50 mm	0,90 mm		
1-4.50-7.62	7,62 m	1-6.35-7.62	7,62 m				
1-4.50-10	10,00 m	1-6.35-10	10,00 m				
1-4.50-15	15,00 m	1-6.35-15	15,00 m				
1-4.50-20	20,00 m	1-6.35-20	20,00 m				
1-4.50-25	25,00 m	1-6.35-25	25,00 m				
1-4.50-30	30,00 m	1-6.35-30	30,00 m				
1-4.50-40	40,00 m	1-6.35-40	40,00 m				
1-4.50-50	50,00 m	1-6.35-50	50,00 m				
1-4.75-5	5,00 m	4,75 mm	0,90 mm			1-6.35-100	100,00 m
1-4.75-7.62	7,62 m			1-8.00-5	5,00 m		
1-4.75-10	10,00 m			1-8.00-7.62	7,62 m		
1-4.75-15	15,00 m			1-8.00-10	10,00 m		
1-4.75-20	20,00 m			1-8.00-15	15,00 m		
1-4.75-25	25,00 m			1-8.00-20	20,00 m		
1-4.75-30	30,00 m			1-8.00-25	25,00 m		
1-4.75-40	40,00 m			1-8.00-30	30,00 m		
1-4.75-50	50,00 m			1-8.00-50	50,00 m		
1-4.75-100	100,00 m			1-10.00-5	5,00 m	10,00 mm	1,00 mm
1-4.75-112	112,00 m	1-10.00-7.50	7,50 m				
1-5.00-5	5,00 m	1-10.00-7.62	7,62 m				
1-5.00-7.62	7,62 m	1-10.00-10	10,00 m				
1-5.00-10	10,00 m	1-10.00-15	15,00 m				
1-5.00-15	15,00 m	1-10.00-20	20,00 m				
1-5.00-20	20,00 m	1-10.00-25	25,00 m				
1-5.00-25	25,00 m	1-10.00-30	30,00 m				
1-5.00-30	30,00 m	1-12.00-5	5,00 m	12,00 mm	1,00 mm		
1-5.00-40	40,00 m	1-12.00-7.60	7,62 m				
1-5.00-50	50,00 m	1-12.00-10	10,00 m				
1-5.00-112	112,00 m	1-12.00-15	15,00 m				
		1-12.00-20	20,00 m				
		1-12.00-25	25,00 m				



Rura miedziano-niklowa CuNi

Copper-nickel tube CuNi / Медно-никелевая труба

INDEX INDEX ИНДЕКС	DŁUGOŚĆ LENGHT ДЛИНА	ŚREDNICA RURY DIAMETER ДИАМЕТР ТРУБЫ	GRUBOŚĆ ŚCIANKI WALL THICKNESS ТОЛЩИНА СТЕНКИ	INDEX INDEX ИНДЕКС	DŁUGOŚĆ LENGHT ДЛИНА	ŚREDNICA RURY DIAMETER ДИАМЕТР ТРУБЫ	GRUBOŚĆ ŚCIANKI WALL THICKNESS ТОЛЩИНА СТЕНКИ
CN-3.50-5	5,00 m	3,50 mm	0,71 mm	CN-6.35-5	5,00 m	6,35 mm	0,71 mm
CN-3.50-7.50	7,50 m			CN-6.35-7.50	7,50 m		
CN-3.50-10	10,00 m			CN-6.35-7.62	7,62 m		
CN-3.50-25	25,00 m			CN-6.35-10	10,00 m		
CN-3.50-30	30,00 m			CN-6.35-15	15,00 m		
CN-3.50-50	50,00 m	CN-6.35-20		20,00 m			
CN-4.50-5	5,00 m	4,50 mm		CN-6.35-25	25,00 m		
CN-4.50-7.50	7,50 m			CN-6.35-50	50,00 m		
CN-4.50-7.62	7,62 m			CN-8.00-5	5,00 m		
CN-4.50-10	10,00 m			CN-8.00-7.50	7,50 m		
CN-4.50-15	15,00 m			CN-8.00-7.62	7,62 m		
CN-4.50-20	20,00 m			CN-8.00-10	10,00 m		
CN-4.50-25	25,00 m			CN-8.00-15	15,00 m		
CN-4.50-30	30,00 m	4,75 mm		CN-8.00-20	20,00 m		
CN-4.50-40	40,00 m			CN-8.00-25	25,00 m		
CN-4.50-50	50,00 m			CN-10.00-5	5,00 m		
CN-4.75-5	5,00 m			CN-10.00-7.50	7,50 m		
CN-4.75-7.50	7,50 m			CN-10.00-7.62	7,62 m		
CN-4.75-7.62	7,62 m			CN-10.00-10	10,00 m		
CN-4.75-10	10,00 m			CN-10.00-15	15,00 m		
CN-4.75-15	15,00 m	6,00 mm	CN-10.00-20	20,00 m			
CN-4.75-20	20,00 m		CN-10.00-25	25,00 m			
CN-4.75-25	25,00 m						
CN-4.75-30	30,00 m						
CN-4.75-40	40,00 m						
CN-4.75-50	50,00 m						
CN-6.00-5	5,00 m						
CN-6.00-7.50	7,50 m						
CN-6.00-7.62	7,62 m						
CN-6.00-10	10,00 m						
CN-6.00-15	15,00 m						
CN-6.00-20	20,00 m						
CN-6.00-25	25,00 m						
CN-6.00-50	50,00 m						



Rura stalowa w powłoce PVF

Steel tube in PVP coating / Стальная труба в оболочке ПРХ

INDEX INDEX ИНДЕКС	DŁUGOŚĆ LENGHT ДЛИНА	ŚREDNICA RURY DIAMETER ДИАМЕТР ТРУБЫ	GRUBOŚĆ ŚCIANKI WALL THICKNESS ТОЛЩИНА СТЕНКИ	INDEX INDEX ИНДЕКС	DŁUGOŚĆ LENGHT ДЛИНА	ŚREDNICA RURY DIAMETER ДИАМЕТР ТРУБЫ	GRUBOŚĆ ŚCIANKI WALL THICKNESS ТОЛЩИНА СТЕНКИ
2-4.75-5	5,00 m	4,75 mm	0,71 mm	2-6.35-5	5,00 m	6,35 mm	0,71 mm
2-4.75-7.62	7,62 m			2-6.35-7.62	7,62 m		
2-4.75-10	10,00 m			2-6.35-10	10,00 m		
2-4.75-15	15,00 m			2-6.35-15	15,00 m		
2-4.75-20	20,00 m			2-6.35-20	20,00 m		
2-4.75-25	25,00 m			2-6.35-25	25,00 m		
2-4.75-30	30,00 m			8,00 mm	2-8.00-5	5,00 m	
2-4.75-31.50	31,50 m				2-8.00-10	10,00 m	
2-4.75-40	40,00 m				2-8.00-15	15,00 m	
2-4.75-50	50,00 m				2-8.00-20	20,00 m	
2-6.00-5	5,00 m				2-8.00-25	25,00 m	
2-6.00-7.62	7,62 m	6,00 mm					
2-6.00-10	10,00 m						
2-6.00-15	15,00 m						
2-6.00-20	20,00 m						
2-6.00-25	25,00 m						
2-6.00-30	30,00 m						



Drobne elementy
układu hamulcowego

Small parts
of braking system

Мелкие детали
тормозной системы

INDEX INDEX ИНДЕКС	ZDJĘCIE PHOTO ФОТО	SCHEMAT SCHEME СХЕМА	INDEX INDEX ИНДЕКС	ZDJĘCIE PHOTO ФОТО	SCHEMAT SCHEME СХЕМА
5-100-102			5-100-105D		
5-100-102X			5-100-105S		
5-100-103			5-100-105X		
5-100-103X			5-100-106		
5-100-103L			5-100-107		
5-100-104			5-100-107X		
5-100-104X			5-100-108		
5-100-105			5-100-108S		
5-100-105A			5-100-109		

Złączki

Fittings / Наконечники

INDEX INDEX ИНДЕКС	ZDJĘCIE PHOTO ФОТО	SCHEMAT SCHEME СХЕМА	INDEX INDEX ИНДЕКС	ZDJĘCIE PHOTO ФОТО	SCHEMAT SCHEME СХЕМА
5-100-110			5-100-116		
5-100-110X			PRZEWODY Z TĄ ZŁĄCZKĄ SĄ ZAWSZE ZAKOŃCZONE SPĘCZKĄ DF !!! BRAKE LINES INCLUDING THIS FITTING ARE ALWAYS DOUBLE FLARED !!! ЭТОТ НАКОНЕЧНИК ПРИМЕНЯЕТСЯ ЧАЩЕ В ЯПОНСКИХ И КОРЕЙСКИХ АВТОМОБИЛЯХ С РАЗВАЛЬЦОВОЙ ТРУБКИ В ВИДЕ ВОРОНКИ !!!		
5-100-111			5-100-116X		
5-100-112			5-100-117		
5-100-113			5-100-118		
5-100-114			5-100-119		
5-100-114S			5-100-120		
5-100-114X			5-100-131		
5-100-115			5-100-160		

INDEX INDEX ИНДЕКС	ZDJĘCIE PHOTO ФОТО	SCHEMAT SCHEME СХЕМА	INDEX INDEX ИНДЕКС	ZDJĘCIE PHOTO ФОТО	SCHEMAT SCHEME СХЕМА
5-100-161			5-100-170		
5-100-162			5-100-170X		
5-100-163			5-100-171		
5-100-164			5-100-171X		
5-100-165			5-100-172		
5-100-166			5-100-173		
5-100-167			5-100-174		
5-100-168			5-100-175		
5-100-169			5-100-500 ZAŚLEPKA / PLUG / ПРОБКА		

Zestaw Duży

Big set / Набор наконечников (Большой)

Index / Index / Индекс: 5-100-01

INDEX INDEX ИНДЕКС	ILOŚĆ QUANTITY КОЛИЧЕСТВО
5-100-103	20 szt/pcs/шт.
5-100-104	25 szt/pcs/шт.
5-100-104X	15 szt/pcs/шт.
5-100-105	100 szt/pcs/шт.
5-100-106	25 szt/pcs/шт.
5-100-107	10 szt/pcs/шт.
5-100-109	20 szt/pcs/шт.
5-100-110	15 szt/pcs/шт.
5-100-110X	10 szt/pcs/шт.
5-100-112	30 szt/pcs/шт.
5-100-115	20 szt/pcs/шт.
5-100-116	50 szt/pcs/шт.



Zestaw Mały

Small set / Набор наконечников (Малый)

Index / Index / Индекс: 5-100-02











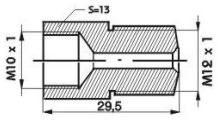

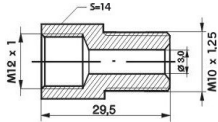

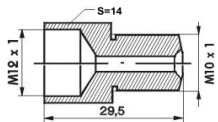

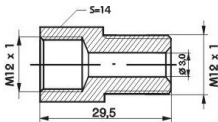

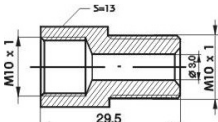

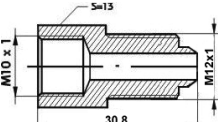

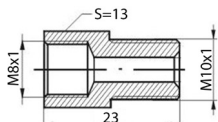

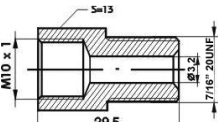

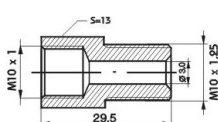

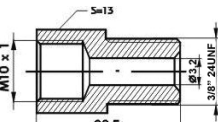

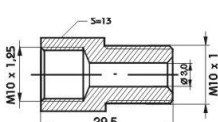

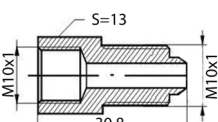
INDEX INDEX ИНДЕКС	ILOŚĆ QUANTITY КОЛИЧЕСТВО
5-100-103	10 szt/pcs/шт.
5-100-104	15 szt/pcs/шт.
5-100-105	50 szt/pcs/шт.
5-100-106	15 szt/pcs/шт.
5-100-107	10 szt/pcs/шт.
5-100-109	15 szt/pcs/шт.
5-100-112	15 szt/pcs/шт.
5-100-116	30 szt/pcs/шт.

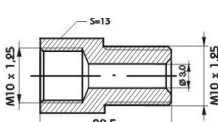

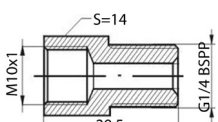
INDEX INDEX ИНДЕКС	ZDJĘCIE PHOTO ФОТО	SCHEMAT SCHEME СХЕМА	INDEX INDEX ИНДЕКС	ZDJĘCIE PHOTO ФОТО	SCHEMAT SCHEME СХЕМА
5-600-121			5-600-142		
5-600-122			5-600-143		
5-600-123			5-600-145		
5-600-124			5-600-148		
5-600-130			5-600-149		
5-600-131			5-600-301		
5-600-133			5-600-302		
5-600-134					

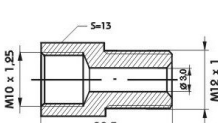

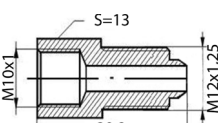

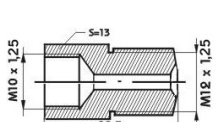



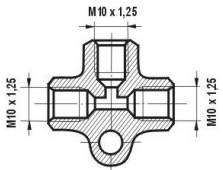

Redukcje

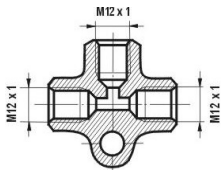
Reducers / Редукторы

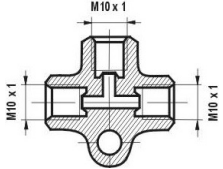
INDEX INDEX ИНДЕКС	ZDJĘCIE PHOTO ФОТО	SCHEMAT SCHEME СХЕМА	INDEX INDEX ИНДЕКС	ZDJĘCIE PHOTO ФОТО	SCHEMAT SCHEME СХЕМА
5-600-129			5-600-146		
5-600-132			5-600-147		
5-600-135			5-600-229		
5-600-135X			5-600-230		
5-600-136			5-600-231		
5-600-137			5-600-232		
5-600-138			5-600-233		
5-600-139			5-600-234		
5-600-144					

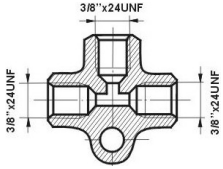

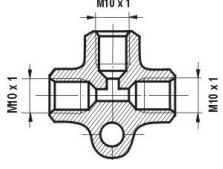

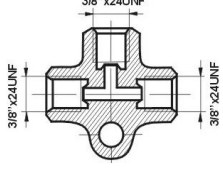



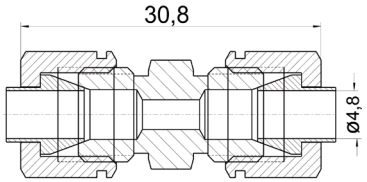
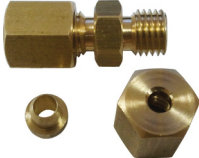
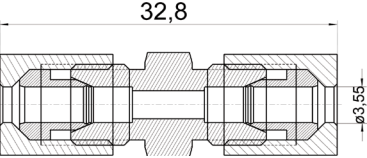

Trójniki

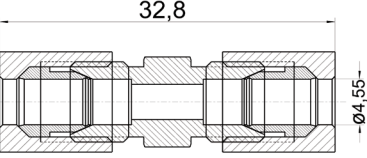
T-connectors / Тройники

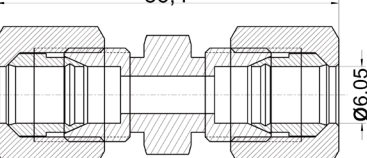
INDEX INDEX ИНДЕКС	ZDJĘCIE PHOTO ФОТО	SCHEMAT SCHEME СХЕМА	INDEX INDEX ИНДЕКС	ZDJĘCIE PHOTO ФОТО	SCHEMAT SCHEME СХЕМА
5-800-125			5-800-128		
5-800-126			5-800-140		
5-800-127			5-800-141		

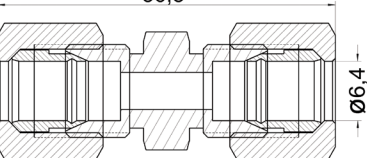
Łączniki do rur

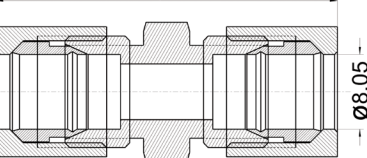

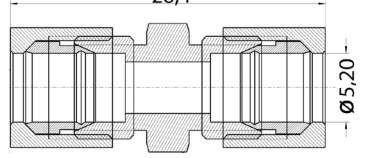







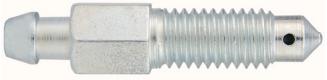
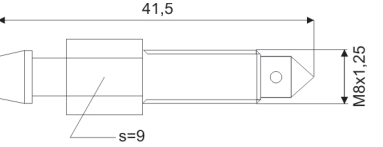
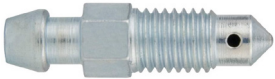
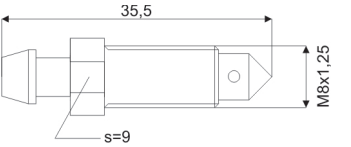

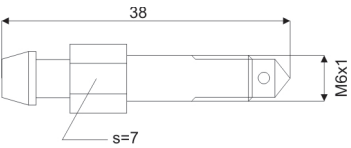

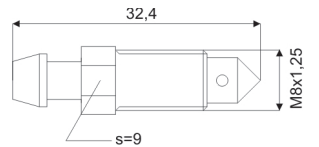

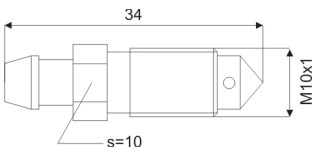
CONNECTORS FOR TUBE / ПЕРЕХОДНИКИ ДЛЯ ТРУБОК

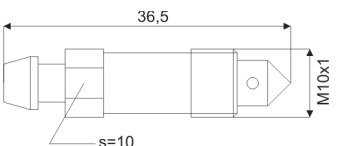
INDEX INDEX ИНДЕКС	ZDJĘCIE PHOTO ФОТО	SCHEMAT SCHEME СХЕМА
5-600-150		
5-600-151		
5-600-152		
5-600-153		
5-600-154		
5-600-155		
5-600-156		

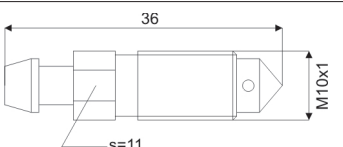
**TYLKO DO RURY MIEDZIANEJ
ONLY FOR THE COPPER TUBES / ТОЛЬКО МЕДНАЯ ТРУБА**

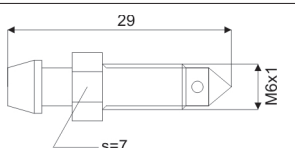

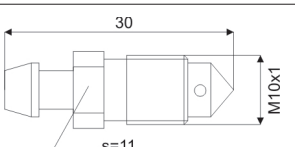
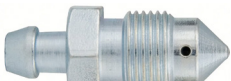
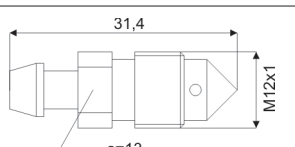

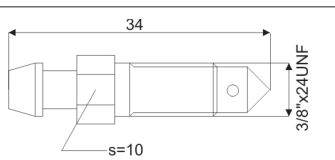





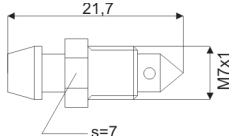

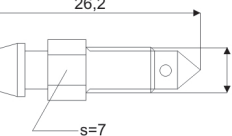

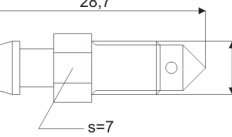

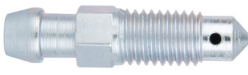
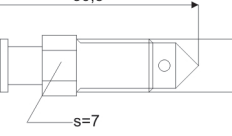
Odpowietrzniki

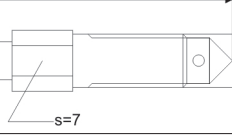
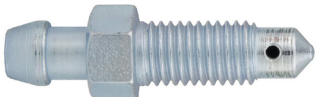
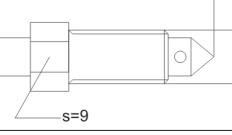
Bleeder screws / Штуцеры прокачки

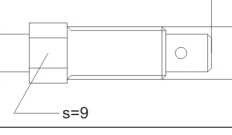
INDEX INDEX ИНДЕКС	ZDJĘCIE PHOTO ФОТО	SCHEMAT SCHEME СХЕМА	ZASTOSOWANIE USE МАРКА АВТОМОБИЛЯ
5-300-0010			MERCEDES-BENZ, OPEL, VAUXHALL
5-300-0011			MERCEDES-BENZ, OPEL, VAUXHALL, SAAB, SKODA, VOLVO
5-300-0013			AUDI, SUBARU, VW
5-300-0015			CITROEN, HONDA, MERCEDES-BENZ, OPEL, SKODA, VAUXHALL
5-300-0017			DAIHATSU, HONDA, MITSUBISHI, NISSAN-DATSUN, ROVER, SUBARU, SUZUKI, TOYOTA, VANDEN-PLAS, VW
5-300-0018			BLMC, FIAT, FORD, OM, TALBOT-SIMCA, TRIUMPH, VOLVO
5-300-0019			FORD, TOYOTA, VW
5-300-0033			AUDI, BMW, SAAB, VW
5-300-0039			ALFA ROMEO, BLMC, CITROEN, FIAT, FORD, HYUNDAI, MERCEDES-BENZ, OM, PEUGEOT, PRINCESS, SAAB, VOLVO, VW
5-300-0040			FORD
5-300-0049			BLMC, FORD, HILLMAN, HUMBER, SINGER, SUNBEAM, TALBOT-SIMCA, VAUXHALL, VOLVO

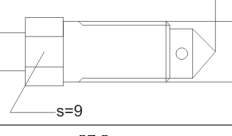

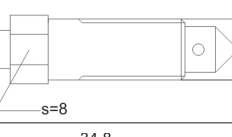

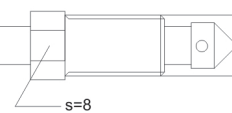





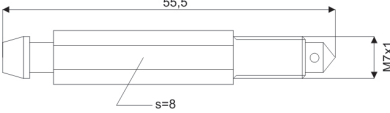

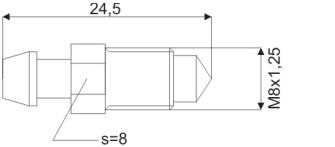
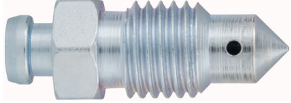
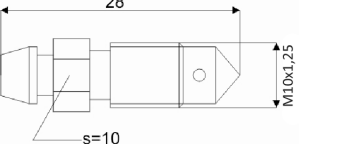

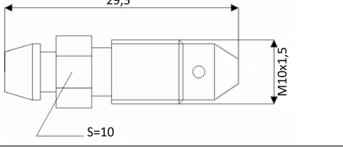
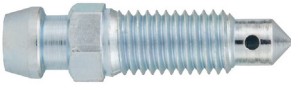
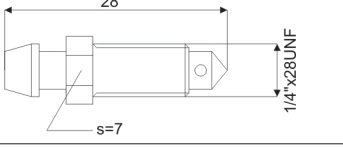
Odpowietrzniki

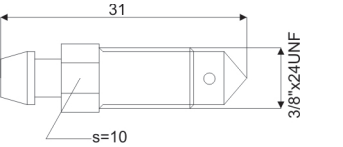
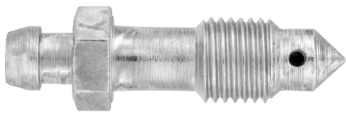
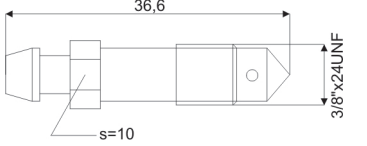
Bleeder screws / Штуцеры прокачки

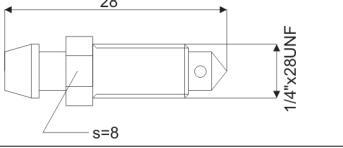
INDEX INDEX ИНДЕКС	ZDJĘCIE PHOTO ФОТО	SCHEMAT SCHEME СХЕМА	ZASTOSOWANIE USE МАРКА АВТОМОБИЛЯ
5-300-0053			ALFA ROMEO, BLMC, BMW, CITROEN, DACIA, DAIHATSU, FORD, ISUZU, MAZDA, NISSAN-DATSUN, PEUGEOT, RENAULT, SEAT, TALBOT-SIMCA, VOLVO, VW
5-300-0053X			ALFA ROMEO, BLMC, BMW, CITROEN, DACIA, DAIHATSU, FORD, ISUZU, MAZDA, NISSAN-DATSUN, PEUGEOT, RENAULT, SEAT, TALBOT-SIMCA, VOLVO, VW
5-300-0069			ALFA ROMEO, BLMC, FORD, MAZDA, PEUGEOT, RENAULT, TALBOT-SIMCA, TOYOTA, VOLVO
5-300-0085			FORD, MERCEDES-BENZ
5-300-0086			ALFA ROMEO, AUDI, BMW, CITROEN, DAF, DAIHATSU, FIAT, FORD, MAZDA, MITSUBISHI, PEUGEOT, RENAULT, SAAB, SUBARU, TALBOT-SIMCA, TOYOTA, VOLVO, VW
5-300-0087			ALFA ROMEO, AUDI, BMW, CITROEN, DAIHATSU, OPEL, PEUGEOT, SUBARU, TALBOT-SIMCA, VAUXHALL, VOLVO, VW
5-300-0088			MERCEDES-BENZ, MITSUBISHI, OPEL, SAAB, TALBOT-SIMCA, TOYOTA, VAUXHALL
5-300-0089			FORD, MAZDA
5-300-0090			MAZDA, OPEL, VAUXHALL
5-300-0091			MAZDA
5-300-0092			CITROEN

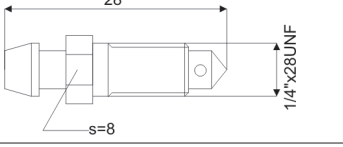
Odpowietrzniki

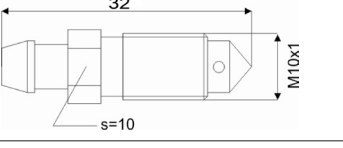
Bleeder screws / Штуцеры прокачки

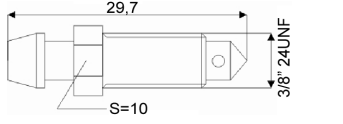
INDEX INDEX ИНДЕКС	ZDJĘCIE PHOTO ФОТО	SCHEMAT SCHEME СХЕМА	ZASTOSOWANIE USE МАРКА АВТОМОБИЛЯ
5-300-0094			FORD
5-300-0100			ALFA ROMEO, AUTOBIANCHI, CITROEN, FIAT, HONDA, LADA, LANCIA, PEUGEOT, POLMO, ROVER, SEAT, TALBOT-SIMCA, VANDEN PLAS, ZASTAWA
5-300-0101			HONDA
5-300-0103			OPEL, VAUXHALL
5-300-0105			BLMC, VAUXHALL
5-300-0107			BLMC, FORD, MG, RILEY, VANDEN PLAS, WOLSELEY
5-300-0108			BLMC, FORD, HILLMAN, JAGUAR, LOTUS, MORGAN, ROVER, SAAB, SUNBEAM, TALBOT-SIMCA, TRIUMPH, VAUXHALL
5-300-0120			IVECO, VOLVO
5-300-0120X			SPECIAL FOR REBUILDING VOLVO
5-300-0131			ŽUK, TICO
5-300-0132			PONTIAC

Zestaw Odpowietrzników

Bleeder screws set / Набор шуцеров прокачки







Index / Index / Индекс: **000Z02**

INDEX INDEX ИНДЕКС	ILOŚĆ QUANTITY КОЛИЧЕСТВО
5-300-0011	10 szt/pcs/шт.
5-300-0013	10 szt/pcs/шт.
5-300-0015	15 szt/pcs/шт.
5-300-0017	15 szt/pcs/шт.
5-300-0019	15 szt/pcs/шт.
5-300-0033	10 szt/pcs/шт.
5-300-0039	15 szt/pcs/шт.
5-300-0053	10 szt/pcs/шт.
5-300-0053x	10 szt/pcs/шт.
5-300-0069	15 szt/pcs/шт.
5-300-0086	20 szt/pcs/шт.
5-300-0087	15 szt/pcs/шт.
5-300-0088	10 szt/pcs/шт.
5-300-0090	10 szt/pcs/шт.
5-300-0100	15 szt/pcs/шт.

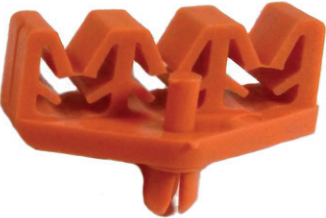

Mocowania do przewodów hamulcowych

Brake line holder / Клипсы крепления тормозных трубок

INDEX INDEX ИНДЕКС	ZDJĘCIE PHOTO ФОТО	ZAKRES ŚREDNIC DIAMETER RANGE ДИАПАЗОН ДИАМЕТРОВ
MPH-60558		4,8 - 6,35 mm
MPH-60559		4,8 - 6,35 mm
MPH-60560		4,8 mm
MPH-60561		4,8 - 8,0 mm
MPH-60562		4,8 - 6,35 mm
MPH-60563		4,8 mm

Specjalistyczne narzędzia

Special tools

Приборы

<p>Stacjonarny przyrząd do spęczania miedzianych przewodów hamulcowych o średnicach: 4,75 mm (3/16") oraz 6,35 mm (1/4"). Urządzenie umożliwia wykonanie dwóch rodzajów spęczeń: pojedyncze SF (gł. do samochodów europejskich) i podwójne DF (do samochodów azjatyckich). Istnieje możliwość poszerzenia zestawu o szczęki do rury o średnicy 6,00 mm oraz 8,00 mm (5/16") i zakuwaki do rury o średnicy 8,00 mm (5/16").</p>	<p>Zestaw zawiera:</p> <ul style="list-style-type: none"> - pudełko, - instrukcję obsługi, - przyrząd do spęczania, - szczęki do rury o średnicy 4,75 mm (3/16"); - szczęki do rury o średnicy 6,35 mm (1/4"); - zakuwaki do rury o średnicy 4,75 mm (3/16"); - zakuwaki do rury o średnicy 6,35 mm (1/4"); - zderzak ustawiający rurkę. <p>Zapytaj o części zamienne.</p>
<p>Stationary flaring tool for copper tubes, operates with following tube diameters: 4,75 mm (3/16") and 6,35 mm (1/4"). Two flare types can be made with this device: single flare (mostly used in european cars) and double flare (mostly used in asian cars). There is a possibility of extending set with clamps for tube diameter: 6,00 mm, 8,00 mm (5/16") and punches for tube diameter: 8,00 mm (5/16")</p>	<p>Set contains:</p> <ul style="list-style-type: none"> - box, - user's manual, - flaring tool, - clamps for tube diameter 4,75 mm (3/16"); - clamps for tube diameter 6,35 mm (1/4"); - punches for tube diameter 4,75 mm (3/16"); - punches for tube diameter 6,35 mm (1/4"); - spacer. <p>Ask for spare parts.</p>
<p>Стационарное прибор развальцовывает медные трубки с диаметром 4,75 мм(3/16") и 6,35 мм(1/4") с высадками в виде грибка (главным образом для европейских автомобилей) и в виде воронки (для азиатских автомобилей). Существует возможность отдельного приобретения планки для зажима трубы и высадки для трубы диаметром 6,00 мм, 8,00 мм (5/16").</p>	<p>В комплекте с прибором используются:</p> <ul style="list-style-type: none"> - коробка - инструкция по эксплуатации - Прибор развальцовывает, - планки для зажима трубы диаметром 4,75 мм (3/16"); - планки для зажима трубы диаметром 6,35 мм (1/4"); - высадки для трубы диаметром 4,75 мм (3/16"); - высадки для трубы диаметром 6,35 мм (1/4"); - фиксирующий трубу упор. <p>Спросите запасных частей.</p>

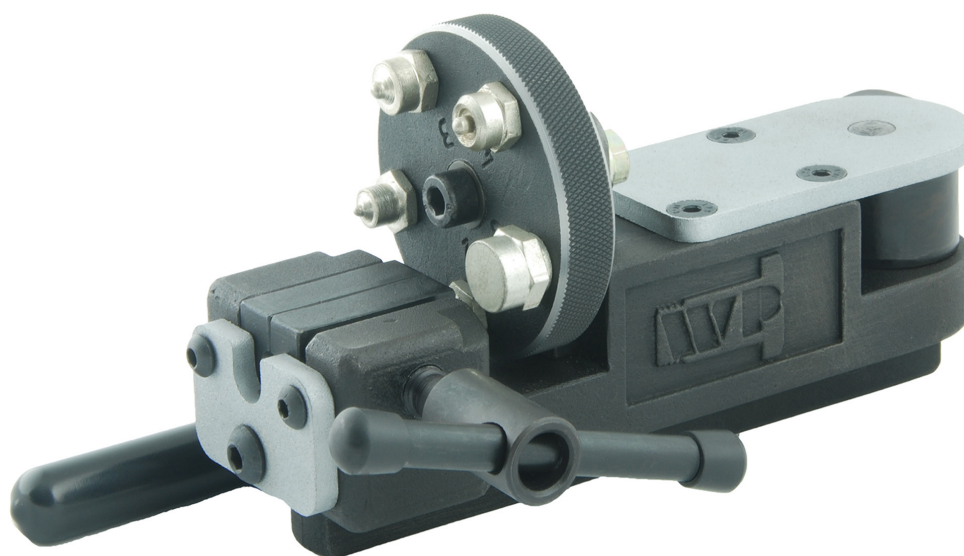

AUTOMATIC 0103

Index: 5-500

Stacjonarny przyrząd do spęczania miedzianych przewodów hamulcowych o średnicach: 4,75 mm (3/16") oraz 6,35 mm (1/4"). Urządzenie umożliwia wykonanie dwóch rodzajów spęczeń: pojedyncze SF (gł. do samochodów europejskich) i podwójne DF (do samochodów azjatyckich).

Zestaw zawiera:

- pudełko,
- instrukcję obsługi,
- przyrząd do spęczania,
- szczęki do rury o średnicy 4,75 mm (3/16");
- szczęki do rury o średnicy 6,35 mm (1/4");
- zakuwaki do rury o średnicy 4,75 mm (3/16");
- zakuwaki do rury o średnicy 6,35 mm (1/4");
- zderzak ustawiający rurkę.

Zapytaj o części zamienne.

Stationary flaring tool for copper tubes, operates with following tube diameters: 4,75 mm (3/16") and 6,35 mm (1/4"). Two flare types can be made with this device: single flare (mostly used in european cars) and double flare (mostly used in asian cars).

Set contains:

- box,
- user's manual,
- flaring tool,
- clamps for tube diameter 4,75 mm (3/16");
- clamps for tube diameter 6,35 mm (1/4");
- punches for tube diameter 4,75 mm (3/16");
- punches for tube diameter 6,35 mm (1/4");
- spacer.

Ask for spare parts.

Стационарное прибор развальцовывает медные трубки с диаметром 4,75 мм(3/16") и 6,35 мм(1/4") с высадками в виде грибка (главным образом для европейских автомобилей) и в виде воронки (для азиатских автомобилей).

В комплекте с прибором используются:

- коробка
- инструкция по эксплуатации
- Прибор развальцовывает,
- планки для зажима трубы диаметром 4,75 мм (3/16");
- планки для зажима трубы диаметром 6,35 мм (1/4");
- высадки для трубы диаметром 4,75 мм (3/16");
- высадки для трубы диаметром 6,35 мм (1/4");
- фиксирующий трубу упор.

Спросите запасных частей.



<p>Stacjonarny przyrząd do spęczniania miedzianych przewodów hamulcowych o średnicach: 4,75 mm (3/16"), 6,00 mm, 6,35 mm (1/4"), 8,00 mm (5/16") oraz 9,52 mm (3/8"). Urządzenie umożliwia wykonanie dwóch rodzajów spęczeń: pojedyncze SF (gł. do samochodów europejskich) i podwójne DF (do samochodów azjatyckich).</p>	<p>Zestaw zawiera:</p> <ul style="list-style-type: none"> - pudełko, - instrukcję obsługi, - przyrząd do spęczniania, - szczęki do rury o średnicy 4,75 mm (3/16"); - szczęki do rury o średnicy 6,00 mm; - szczęki do rury o średnicy 6,35 mm (1/4"); - szczęki do rury o średnicy 8,00 mm (5/16"); - szczęki do rury o średnicy 9,52 mm (3/8"); - komplet zakuwaków na bębnie - 4,75 mm (3/16"), 6,00 mm, 6,35 mm (1/4"), 8,00 mm (5/16"), 9,52 mm (3/8"). <p>Zapytaj o części zamienne.</p>
<p>Stationary flaring tool for copper tubes, operates with following tube diameters: 4,75 mm (3/16"), 6,00 mm, 6,35 mm (1/4"), 8,00 mm (5/16"), 9,52 mm (3/8"). Two flare types can be made with this device: single flare (mostly used in european cars) and double flare (mostly used in asian cars).</p>	<p>Set contains:</p> <ul style="list-style-type: none"> - box, - user's manual, - flaring tool, - clamps for tube diameter 4,75 mm (3/16"); - clamps for tube diameter 6,00 mm; - clamps for tube diameter 6,35 mm (1/4"); - clamps for tube diameter 8,00 mm (5/16"); - clamps for tube diameter 9,52 mm (3/8"); - set of punches on drum - 4,75 mm (3/16"), 6,00 mm, 6,35 mm (1/4"), 8,00 mm (5/16"), 9,52 mm (3/8"). <p>Ask for spare parts.</p>
<p>Стационарное прибор развальцовывает медные трубки с диаметром 4,75 mm (3/16"), 6,00 mm, 6,35 mm (1/4"), 8,00 mm (5/16"), 9,52 mm (3/8"). с высадками в виде грибка (главным образом для европейских автомобилей) и в виде воронки (для азиатских автомобилей).</p>	<p>В комплекте с прибором используются:</p> <ul style="list-style-type: none"> - коробка - инструкция по эксплуатации - Прибор развальцовывает, - планки для зажима трубы диаметром 4,75 mm (3/16"); - планки для зажима трубы диаметром 6,00 mm; - планки для зажима трубы диаметром 6,35 mm (1/4"); - планки для зажима трубы диаметром 8,00 mm (5/16"); - планки для зажима трубы диаметром 9,52 mm (3/8"); - комплект высадок в барабане - 4,75 mm (3/16"), 6,00 mm, 6,35 mm (1/4"), 8,00 mm (5/16"), 9,52 mm (3/8"). <p>Спросите запасных частей.</p>

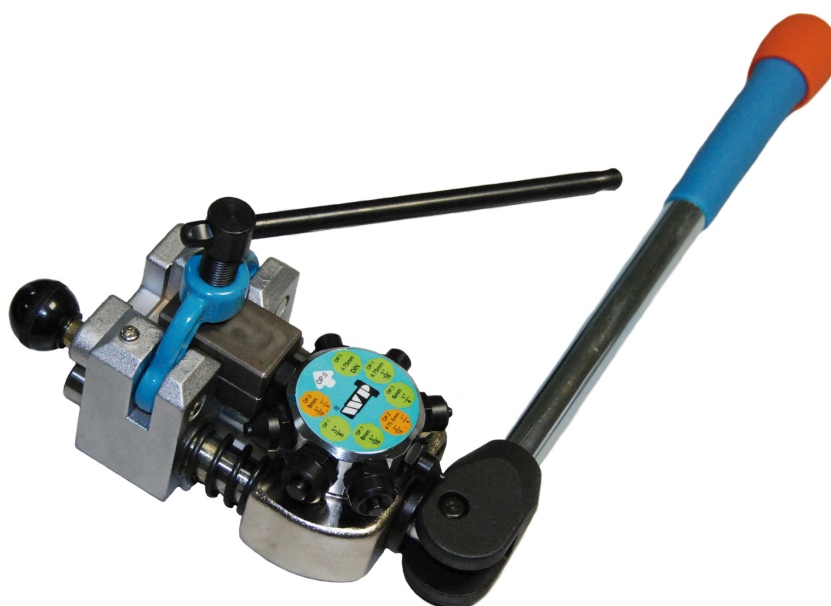

FTD 414

Index: 5-FTD-414

Przyrząd do spęczenia miedzianych przewodów hamulcowych o średnicach: 4,75 mm (3/16"), 6,00 mm oraz 6,35 mm (1/4"). Urządzenie umożliwia wykonanie dwóch rodzajów spęczeń: pojedyncze SF (gł. do samochodów europejskich) i podwójne DF (do samochodów azjatyckich).

Zestaw zawiera:

- pudełko,
- instrukcję obsługi,
- przyrząd do spęczenia,
- szczęki do rury o średnicy 4,75 mm (3/16");
- szczęki do rury o średnicy 6,00 mm;
- szczęki do rury o średnicy 6,35 mm (1/4");
- zakuwak do rury o średnicy 4,75 mm (3/16");
- zakuwak do rury o średnicy 6,00 mm;
- zakuwak do rury o średnicy 6,35 mm (1/4");
- gradownik do rur.

Zapytaj o części zamienne.

Flaring tool for copper tubes, operates with following tube diameters: 4,75 mm (3/16"), 6,00 mm, 6,35 mm (1/4"). Two flare types can be made with this device: single flare (mostly used in european cars) and double flare (mostly used in asian cars).

Set contains:

- box,
- user's manual,
- flaring tool,
- clamps for tube diameter 4,75 mm (3/16");
- clamps for tube diameter 6,00 mm;
- clamps for tube diameter 6,35 mm (1/4");
- punch for tube diameter 4,75 mm (3/16");
- punch for tube diameter 6,00 mm;
- punch for tube diameter 6,35 mm (1/4");
- deburring tool.

Ask for spare parts.

Прибор развальцовывает медные трубки с диаметром 4,75 мм (3/16"), 6,00 мм, 6,35 мм (1/4"). с высадками в виде грибка (главным образом для европейских автомобилей) и в виде воронки (для азиатских автомобилей).

В комплекте с прибором используются:

- коробка
- инструкция по эксплуатации,
- Прибор развальцовывает,
- планки для зажима трубы диаметром 4,75 мм (3/16");
- планки для зажима трубы диаметром 6,00 мм;
- планки для зажима трубы диаметром 6,35 мм (1/4");
- высадки для трубы диаметром 4,75 мм (3/16");
- высадки для трубы диаметром 6,00 мм;
- высадки для трубы диаметром 6,35 мм (1/4");
- приспособление для снятия заусенцев.

Спросите запасных частей.

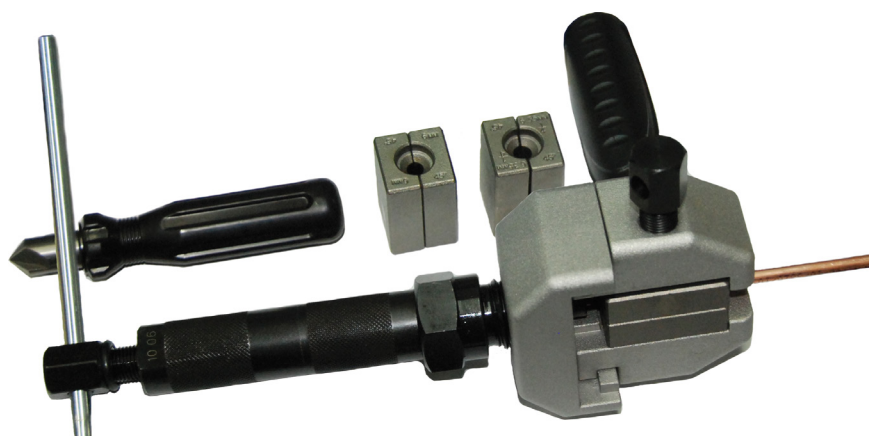

<p>Przyrząd do spęczania miedzianych przewodów hamulcowych o średnicach: 4,75 mm (3/16"), 6,35 mm (1/4"), 8 mm (5/16"), 9,52 mm (3/8"), 11,11 mm (7/16"), 12,70 mm (1/2"), 15,88 mm (5/8"). Urządzenie umożliwia wykonanie dwóch rodzajów spęczeń: pojedyncze SF (gł. do samochodów europejskich) i podwójne DF (do samochodów azjatyckich).</p>	<p>Zestaw zawiera:</p> <ul style="list-style-type: none"> - pudełko, - instrukcję obsługi, - przyrząd do spęczania, - komplet zakuwaków - 4,75 mm (3/16"), 6,35 mm (1/4"), 8 mm (5/16"), 9,52 mm (3/8"), 11,11 mm (7/16"), 12,70 mm (1/2"), 15,88 mm (5/8"); - mini przecinak do rur miedzianych; - gradownik do rur. <p>Zapytaj o części zamienne.</p>
<p>Flaring tool for copper tubes, operates with following tube diameters: 4,75 mm (3/16"), 6,35 mm (1/4"), 8 mm (5/16"), 9,52 mm (3/8"), 11,11 mm (7/16"), 12,70 mm (1/2"), 15,88 mm (5/8"). Two flare types can be made with this device: single flare (mostly used in european cars) and double flare (mostly used in asian cars).</p>	<p>Set contains:</p> <ul style="list-style-type: none"> - box, - user's manual, - flaring tool, - set of punches - 4,75 mm (3/16"), 6,35 mm (1/4"), 8 mm (5/16"), 9,52 mm (3/8"), 11,11 mm (7/16"), 12,70 mm (1/2"), 15,88 mm (5/8"); - mini cutter for copper tubes; - inner reamer for tubes. <p>Ask for spare parts.</p>
<p>Прибор развальцовывает медные трубки с диаметром: 4,75 мм (3/16"), 6,35 мм (1/4"), 8 мм (5/16"), 9,52 мм (3/8"), 11,11 мм (7/16"), 12,70 мм (1/2"), 15,88 мм (5/8"). с высадками в виде грибка (главным образом для европейских автомобилей) и в виде воронки (для азиатских автомобилей).</p>	<p>В комплекте с прибором используются:</p> <ul style="list-style-type: none"> - коробка - инструкция по эксплуатации, - Прибор развальцовывает, - комплект высадок - 4,75 мм (3/16"), 6,35 мм (1/4"), 8 мм (5/16"), 9,52 мм (3/8"), 11,11 мм (7/16"), 12,70 мм (1/2"), 15,88 мм (5/8"); - мини резак для медных трубок; - приспособление для снятия заусенцев. <p>Спросите запасных частей.</p>



FTC 03 CIT

Specjalny do Citroena/Special for Citroen/Специально для Citroen

Index: 5-FTC03-CIT

<p>Stacjonarny przyrząd do spęczania miedzianych przewodów hamulcowych oraz hydraulicznych o średnicach: 3,50 mm, 4,50 mm, 6,35 mm (1/4") do samochodów marki Citroen (2CV, BX, CX, XM, XANTIA).</p>	<p>W zestawie z przyrządem znajdują się:</p> <ul style="list-style-type: none">- pudełko,- instrukcję obsługi,- przyrząd do spęczania,- szczęki do rury o średnicy 3,50 mm;- szczęki do rury o średnicy 4,50 mm;- szczęki do rury o średnicy 6,35 mm (1/4");- zakuwak do rury o średnicy 3,50 mm;- zakuwak do rury o średnicy 4,50 mm;- zakuwak do rury o średnicy 6,35 mm (1/4"). <p>Zapytaj o części zamienne.</p>
<p>Stationary flaring tool for copper Brake and hydraulic tubes, operates with following tube diameters: 3,50 mm, 4,50 mm, 6,35 mm (1/4") - dedicated to Citroen vehicles (2CV, BX, CX, XM, XANTIA).</p>	<p>Set contains:</p> <ul style="list-style-type: none">- box,- user's manual,- flaring tool,- clamps for tube diameter 3,50 mm;- clamps for tube diameter 4,50 mm;- clamps for tube diameter 6,35 mm (1/4");- punch for tube diameter 3,50 mm;- punch for tube diameter 4,50 mm;- punch for tube diameter 6,35 mm (1/4"). <p>Ask for spare parts.</p>
<p>Стационарное прибор для заготовки тормозных и гидравлических трубок диаметром 3,50 мм, 4,50 мм, 6,35 мм (1/4") для автомобилей Citroen (2CV, BX, CX, XM, XANTIA).</p>	<p>В комплекте с прибором используются:</p> <ul style="list-style-type: none">- коробка- инструкция по эксплуатации,- Прибор развальцовывает,- планки для зажима трубы диаметром 3,50 мм;- планки для зажима трубы диаметром 4,50 мм;- планки для зажима трубы диаметром 6,35 мм (1/4");- высадки для трубы диаметром 3,50 мм (3/16");- высадки для трубы диаметром 4,50 мм;- высадки для трубы диаметром 6,35 мм (1/4"). <p>Спросите запасных частей.</p>

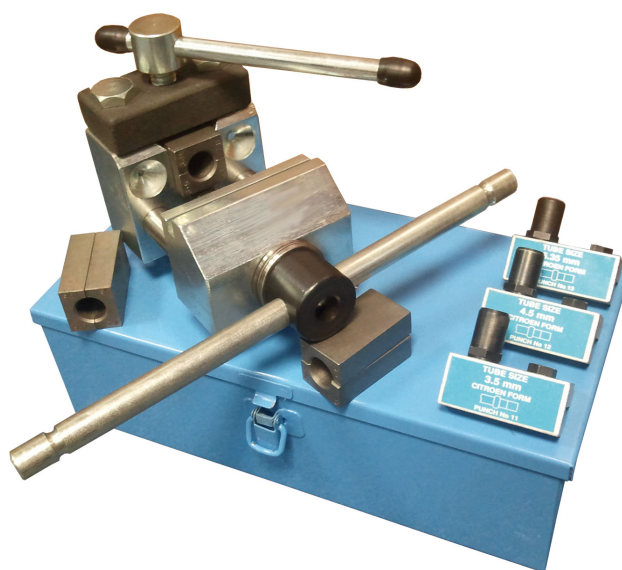

TB 346

Index: 5-TB-346

Giętarka ręczna do rur o średnicy 3 - 6mm.
Kąt gięcia 0 - 90°.

Tubing bender for sizes 3 - 6mm.
Bend angle 0 - 90°.

Ручной трубогиб для трубок диаметром 3 - 6 мм.
Угол гибки 0 - 90°.



TB 312M

Index: 5-TB-312M

Giętarka ręczna do rur o średnicy 6 - 10 mm.
Kąt gięcia 0 - 180°.

Tubing bender for sizes 6 - 10 mm.
Bend angle 0 - 180°.

Ручной трубогиб для трубок диаметром 6 - 10 мм.
Угол гибки 0 - 180°.



TB 410

Index: 5-TB-410

Giętarka ręczna do rur o średnicy: 4,75 - 10 mm.
Kąt gięcia 0 - 90°.

Tubing bender for sizes: 4,75 - 10 mm.
Bend angle 0 - 90°.

Ручной трубогиб для трубок диаметром: 4,75 - 10 мм.
Угол гибки 0 - 90°.



DT 601

Index: 5-DT601

Gradownik do rur.

Inner reamer for tubes.

Приспособление для снятия заусенцев.



TCM 130D

Index: 5-TCM-130D

Mini przecinarka do rur miedzianych o średnicy 3 - 16 mm.

Mini cutter for copper tubes for sizes 3 - 16 mm.

Мини резак для медных трубок диаметром 3 - 16 мм.



TCM 110A

Index: 5-TCM-110A

Przecinarka do rur miedzianych o średnicy 3 - 28 mm.

Cutter for copper tubes for sizes 3 - 28 mm.

Резак для медных трубок диаметром 3 - 28 мм.



Przyrząd do odpowietrzania układu hamulcowego

Brake lines bleeding tool / Прибор для прокачки тормозов

Index: 5-TCM-110A

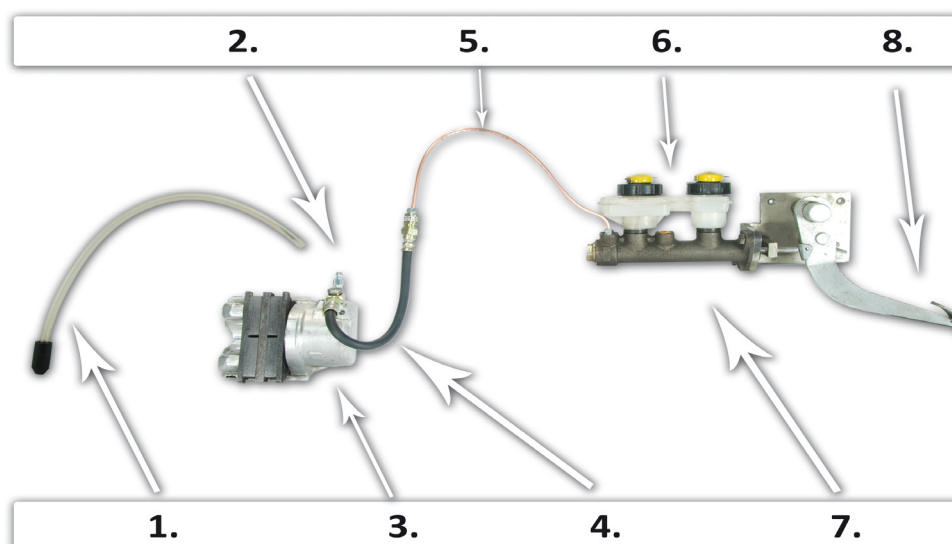

1.	Przyrząd do odpowietrzania	Brake lines bleeding tool	Прибор для прокачки тормозов
2.	Odpowietrznik	Bleeder Screw	Штуцер прокачки
3.	Zacisk	Brake caliper	Клемма
4.	Przewód hamulcowy elastyczny	Brake hose	Тормозный шланг
5.	Przewód hamulcowy	Brake line	Тормозная трубка
6.	Zbiorniczek na płyn hamulcowy	Brake fluid supply tank	Ёмкость для слива тормозной жидкости
7.	Pompa hamulcowa	Brake master cylinder	Тормозный насос
8.	Pedał hamulca	Brake pedal	Педаль тормоза







Rozpieracze, samoregulatory

Adjusters, selfregulators



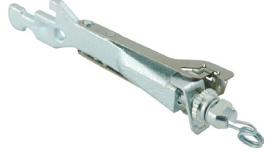

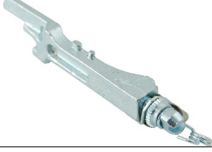
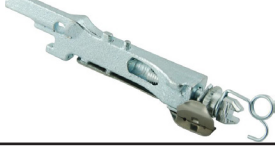

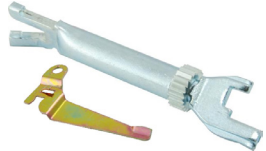

Саморегулирующиеся
и распорные планки

INDEKS INDEX ИНДЕКС	POŁOŻENIE* LOCATION* РАСПОЛОЖЕНИЕ	MARKA/MODEL BRAND/MODEL МАРКА АВТОМОБИЛЯ	ROK PRODUKCJI PRODUCTION YEAR ГОД ВЫПУСКА	WYMIARY BĘBNA DRUM SIZE РАЗМЕРЫ БАРАБАНА	REFERENCJE REFERENCES ПРОИЗВОДИТЕЛЬ	ZDJĘCIE PHOTO ФОТО
WPS-1.949	TP	FIAT Tempra PEUGEOT 405 RENAULT Express		Daico nr 49.92.2197 BENDIX R.A.D. Trusting nr BI 23		
WPS-1.950	TL					
WPS-1.1052	TP	DAEWOO Matiz	04.98>02.05	180x31	DAEWOO	
WPS-1.1053	TL					
WPS-1.1072	TP	RENAULT Clio		180x40	VARGA	
WPS-1.1073	TL					
WPS-1.1076	TP	CITROEN Xsara ZX PEUGEOT 205 306 306(N5) -DAM8210 309	02.96>10.00 03.91>10.97	180x30 180x30; 180x40	LUCAS	
WPS-1.1077	TL					03.83>12.97 05.93>08.95 04.97>04.99 09.85>94
WPS-1.1078	TP	RENAULT Espace II Express/Rapid	01.91>10.96 07.85>03.98	229x42	LUCAS	
WPS-1.1079	TL					
WPS-1.1082	TP	MERCEDES 180D			LUCAS	
WPS-1.1083	TL					

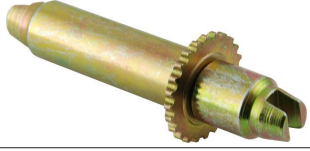



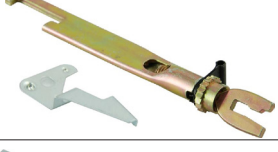
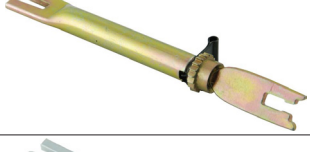

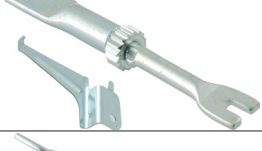
* - TP = Tył prawy / Rear right / Зад Правый, TL = Tył lewy / Rear left / Зад Левый

INDEKS INDEX ИНДЕКС	POŁOŻENIE* LOCATION* РАСПОЛОЖЕНИЕ	MARKA/MODEL BRAND/MODEL МАРКА АВТОМОБИЛЯ	ROK PRODUKCJI PRODUCTION YEAR ГОД ВЫПУСКА	WYMIARY BĘBNA DRUM SIZE РАЗМЕРЫ БАРАБАНА	REFERENCJE REFERENCES ПРОИЗВОДИТЕЛЬ	ZDJĘCIE PHOTO ФОТО
WPS-1.1086	TP	OPEL Astra Corsa Tigra	92>98 07.84>91 94>	200x30	OPEL	
WPS-1.1087	TL					
WPS-1.1100	TP	CITROEN ZX FIAT Punto Tempra Tipo LANCIA Debra -ABS PEUGEOT 206 306(N3) 306(N5) RENAULT Clio I Clio II Express/Rapid R11 - Turbo R19 R21 Sedan R5 Super R9 Twingo	03.91>10.97 01.93>12.97 11.89>08.96 88>95 01.90>07.99 09.98>08.01 09.95>03.97 04.97>04.02	180x30 180x30 180x30 180x30	Bendix	
	WPS-1.1101					TL
WPS-1.1106	TP/TL	FIAT Punto II	1999-	180x40		
WPS-1.1114	TP	PEUGEOT 206 RENAULT 19		Daico nr 49.92.2196 System Bendix Trusting nr BI 22.1A		
WPS-1.1115	TL					
WPS-1.1129	TL	ALFA ROMEO 33 145 146 CITROEN Dispatch Evasion Jumpy Synergie Xsara ZX FIAT Brava Bravo Marea PEUGEOT 306(N5) DAM 8211- 405 Sedan ch.71407667-	83>08.94 07.94>02.01 07.94>02.01 10.95>08.00 06.94>07.02 10.95>12.06 10.95>08.00 11.00>08.05 03.91>10.97 09.95>10.01 09.95>10.01 10.98>08.02	203x38 255x60 255x60 255x60 229x40 229x40 203x38	Bendix	
						RENAULT Clio II Express/Rapid Kangoo Megane I R19 SMART Cabrio City-Coupe Crossblade Fortwo Roadstar
WPS-1.1130	TP				Bosch	

* - TP = Tył prawy / Rear right / Зад Правый, TL = Tył lewy / Rear left / Зад Левый

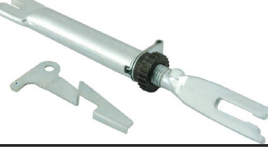
INDEKS INDEX ИНДЕКС	POŁOŻENIE* LOCATION* РАСПОЛОЖЕНИЕ	MARKA/MODEL BRAND/MODEL МАРКА АВТОМОБИЛЯ	ROK PRODUKCJI PRODUCTION YEAR ГОД ВЫПУСКА	WYMIARY BĘBNA DRUM SIZE РАЗМЕРЫ БАРАБАНА	REFERENCJE REFERENCES ПРОИЗВОДИТЕЛЬ	ZDJĘCIE PHOTO ФОТО
WPS-1.1284	TP	FIAT Palio Siena	04.96> 04.95>	185x29	ATE	
WPS-1.1285	TL					
WPS-1.1302	TP	MERCEDES Sprinter				
WPS-1.1303	TL					
WPS-1.1358	TP	PEUGEOT 405 kombi Partner	87>95 97>	228x40	LUCAS	
WPS-1.1359	TL					
WPS-1.1397	TP	CITROEN C2 C3 PEUGEOT 1007 RENAULT Laguna	09.03> 02.02>	203x38	LUCAS	
WPS-1.1398	TL		04.05> 11.93>02.01	203x38 202x37		
WPS-1.1399	TP	RENAULT Laguna Megane I Scenic	11.93>02.01 01.96>10.02 10.99>05.03	229x38	LUCAS	
WPS-1.1400	TL					
WPS-1.1401	TP	CITROEN Jumper Realy FIAT Ducato PEUGEOT Boxer	02.94>03.02	254x57	LUCAS	
WPS-1.1402	TL					

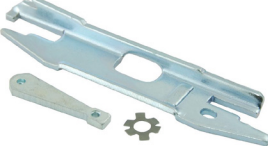
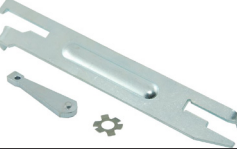
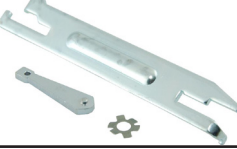





* - TP = Tył prawy / Rear right / Зад Правый, TL = Tył lewy / Rear left / Зад Левый

INDEKS INDEX ИНДЕКС	POŁOŻENIE* LOCATION* РАСПОЛОЖЕНИЕ	MARKA/MODEL BRAND/MODEL МАРКА АВТОМОБИЛЯ	ROK PRODUKCJI PRODUCTION YEAR ГОД ВЫПУСКА	WYMIARY BĘBNA DRUM SIZE РАЗМЕРЫ БАРАБАНА	REFERENCJE REFERENCES ПРОИЗВОДИТЕЛЬ	ZDJĘCIE PHOTO ФОТО
WPS-1.1462	TP	CITROEN Xsara ZX FIAT Punto Tempra Tipo PEUGEOT 206	96>00 91>98 93> 89>96 88>93	180x30	LUCAS	
WPS-1.1463	TL	RENAULT Clio R11 R19 R21 R21 R5 Super R9 Twingo	90>96 86>87 92>96 86>87 91>94 87>91 86>87 93>98			
WPS-1.1530	TP	CITROEN Jumper Realy FIAT Ducato PEUGEOT Boxer	02.94>03.02	254x57	LUCAS	
WPS-1.1531	TL					
WPS-1.1601	TP	AUDI 80 90 A2 SEAT Arosa Cordoba Ibiza II Ibiza III Toledo I SKODA Fabia Favorit Felicja VW Caddy II Fox Golf Golf IV Lupo Passat Limousine Polo Vento	02.89>08.90 02.89>08.90 06.00>08.05 05.97>06.04 06.99>06.02 01.93>07.99 08.99>02.02 07.91>03.99 12.99> 01.93>09.94 10.94>08.01 11.95>02.04 10.03> 11.91>09.97 10.97>06.05 10.98>07.05 04.88>09.89 02.96> 11.91>09.98	200x40	VW	
WPS-1.1602	TL					
WPS-1.1603	TP	SKODA Octavia Roomster	09.96>05.04 09.06>	230X32	ATE	
WPS-1.1604	TL					
WPS-1.1611	TP	OPEL Astra G Vectra B Zafira VAUXHALL Astra G Vectra Zafira	04.98>10.05 09.95>07.03 04.99>06.05 03.98>05 09.95>03.02 04.99>06.05	228,6x42	LUCAS	
WPS-1.1612	TL					

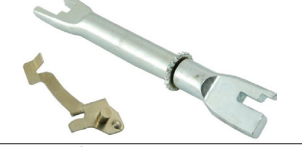
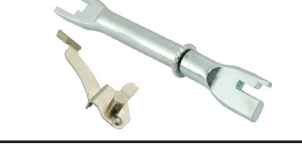
* - TP = Tył prawy / Rear right / Зад Правый, TL = Tył lewy / Rear left / Зад Левый

INDEKS INDEX ИНДЕКС	POŁOŻENIE* LOCATION* РАСПОЛОЖЕНИЕ	MARKA/MODEL BRAND/MODEL МАРКА АВТОМОБИЛЯ	ROK PRODUKCJI PRODUCTION YEAR ГОД ВЫПУСКА	WYMIARY BĘBNA DRUM SIZE РАЗМЕРЫ БАРАБАНА	REFERENCJE REFERENCES ПРОИЗВОДИТЕЛЬ	ZDJĘCIE PHOTO ФОТО
WPS-1.1621	TP	MERCEDES A (W 168)	09.97>08.04	180x49	LUCAS	
WPS-1.1622	TL					
WPS-1.1631	TP	TOYOTA Carina E Corolla	02.92>09.97 08.98>01.02	200x37	LUCAS	
WPS-1.1632	TL					
WPS-1.1641	TP	NISSAN Micra	08.92>12.02	180x25	LUCAS	
WPS-1.1642	TL					
WPS-1.1651	TP	OPEL Agila VAUXHALL Agila	03.00> 09.00>	180x26	OPEL	
WPS-1.1652	TL					
WPS-1.1711	TP	TOYOTA Corolla	05.83>04.97	200x35	SUMITAMO	
WPS-1.1712	TL					
WPS-1.1721	TP	TOYOTA RAV 4 II	05.00>02.06	228,6x40	SUMITAMO	
WPS-1.1722	TL					

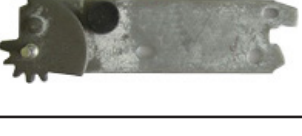
* - TP = Tył prawy / Rear right / Зад Правый, TL = Tył lewy / Rear left / Зад Левый

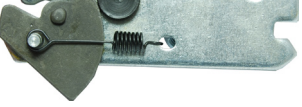
INDEKS INDEX ИНДЕКС	POŁOŻENIE* LOCATION* РАСПОЛОЖЕНИЕ	MARKA/MODEL BRAND/MODEL МАРКА АВТОМОБИЛЯ	ROK PRODUKCJI PRODUCTION YEAR ГОД ВЫПУСКА	WYMIARY BĘBNA DRUM SIZE РАЗМЕРЫ БАРАБАНА	REFERENCJE REFERENCES ПРОИЗВОДИТЕЛЬ	ZDJĘCIE PHOTO ФОТО
WPS-1.1731	TP	TOYOTA Yaris Yaris Verso	01.99>12.05 08.99>12.05	207x30	TOYOTA	
WPS-1.1732	TL					
WPS-1.1811	TP	HYUNDAI Accent (X-3) Atos Exel Getz(TB) Pony (X-2)	07.93>12.99 02.98> 08.09>08.99 09.02> 08.89>08.99	180x37 180x32 180x37 180x32 180x37	SUMITAMO MANDO SUMITAMO MANDO SUMITAMO	
WPS-1.1812	TL					
WPS-1.F010	TP	FORD Escort Orion	90>93	203x38	LUCAS	
WPS-1.F011	TL					
WPS-1.F020	TP	FORD Focus	08.98>04.05	202x37	LUCAS	
WPS-1.F021	TL					
WPS-1.F030	TP	FORD Mondeo	01.93>10.00	228x44	LUCAS	
WPS-1.F031	TL					
WPS-1.F040	TP	FORD Escort Fiesta Ka Puma MAZDA 121 III	91> 09.95> 96> 97> 04.96>10.02	180x30	LUCAS	
WPS-1.F041	TL					

* - TP = Tył prawy / Rear right / Зад Правый, TL = Tył lewy / Rear left / Зад Левый

INDEKS INDEX ИНДЕКС	POŁOŻENIE* LOCATION* РАСПОЛОЖЕНИЕ	MARKA/MODEL BRAND/MODEL МАРКА АВТОМОБИЛЯ	ROK PRODUKCJI PRODUCTION YEAR ГОД ВЫПУСКА	WYMIARY BĘBNA DRUM SIZE РАЗМЕРЫ БАРАБАНА	REFERENCJE REFERENCES ПРОИЗВОДИТЕЛЬ	ZDJĘCIE PHOTO ФОТО
WPS-1.F050	TP	FORD Transit	03.00>06.06	254X52 280X64	BOSCH	
WPS-1.F051	TL					
WPS-1.IV01	TP/TL	IVECO DAILY	96-			
WPS-1.IV02	TP/TL	IVECO DAILY				
WPS-1.IV03	TP/TL	IVECO DAILY 65C13/15				
WPS.BAS127	LH	MERCEDES Sprinter Cdi (901,902,903,906) Vito Cdi (W639) VW Crafter (30-50)	04.2000> 09.2003> 04.2006>			
WPS.BAS128	TP/TL	MERCEDES Sprinter Cdi (901,902,903,906) VW Crafter (30-50)	04.2000> 04.2006>			
WPS.BAS129	TP/TL	MERCEDES Vito Cdi (W639)	09.2003>			
WPB 1.1040	TP/TL	FIAT Brava Bravo Panda Punto FORD Escort Fiesta Ka Puma LANCIA Y MAZDA 121 III	09.95>10.01 09.95>10.01 09.03> 11.93>05.03 01.95>08.00 12.94>02.02 09.96> 05.97>02.00 11.95>09.03 04.96>10.02	180x30 180x32 180x30 180x32	AP LOCKHEED	

* - TP = Tył prawy / Rear right / Зад Правый, TL = Tył lewy / Rear left / Зад Левый











Blaszki do rozpieraczy

Adjuster levers











Пластинки для распорных планок

INDEKS INDEX ИНДЕКС	POŁOŻENIE* LOCATION* РАСПОЛОЖЕНИЕ	ZASTOSOWANIE APPLICATION ПРИЛОЖЕНИЕ	REFERENCJE REFERENCES ПРОИЗВОДИТЕЛЬ	ZDJĘCIE PHOTO ФОТО
WPB-1.963	TP	WPS-1.1076	CITROEN Xsara ZX PEUGEOT 205 306 306(NS) 309	
WPB-1.964	TL	WPS-1.1077		
WPB-1.1080	TP	WPS-1.1078	RENAULT Espace II Express/Rapid	
WPB-1.1081	TL	WPS-1.1079		
WPB-1.1084	TP	WPS-1.1082	MERCEDES Mercedes Benz 180D	
WPB-1.1085	TL	WPS-1.1083		
WPB-1.1088	TP	WPS-1.1052 WPS-1.1086 WPS-1.1611	DAEWOO Matiz OPEL Astra Corsa Tigra Astra G Vectra B Zafira	
WPB-1.1089	TL	WPS-1.1053 WPS-1.1087 WPS-1.1612		
WPB-1.1126	TP	WPS-1.1072	RENAULT Clio	
WPB-1.1127	TL	WPS-1.1073		





* - TP = Tył prawy / Rear right / Зад Правый, TL = Tył lewy / Rear left / Зад Левый

INDEKS INDEX ИНДЕКС	POŁOŻENIE* LOCATION* РАСПОЛОЖЕНИЕ	ZASTOSOWANIE APPLICATION ПРИЛОЖЕНИЕ	REFERENCJE REFERENCES ПРОИЗВОДИТЕЛЬ	ZDJĘCIE PHOTO ФОТО
WPB-16.1173	TP	WPS-1.1129	RENAULT 19 RT PEUGEOT 405	
WPB-16.1174	TL	WPS-1.1130		
WPB-1.1286	TP	WPS-1.1284	FIAT Palio Siena	
WPB-1.1287	TL	WPS-1.1285		
WPB-1.1314	TP	WPS-1.1358 WPS-1.1400	PEUGEOT Partner 05 kombi RENAULT Laguna Megane I Scenic	
WPB-1.1315	TL	WPS-1.1359 WPS-1.1399		
WPB-1.1395	TP	WPS-1.1399 WPS-1.1622 WPS-1.1633 WPS-1.1642	CITROEN C2 C3 PEUGEOT 1007 RENAULT Laguna MERCEDES W 168 TOYOTA Carina E Corolla NISSAN Micra	
WPB-1.1396	TL	WPS-1.1398 WPS-1.1621 WPS-1.1631 WPS-1.1641		
WPB-1.1403	TP	WPS-1.1401	CITROEN Jumper Realy FIAT Ducato PEUGEOT Boxer	
WPB-1.1404	TL	WPS-1.1402		

* - TP = Tył prawy / Rear right / Зад Правый, TL = Tył lewy / Rear left / Зад Левый

INDEKS INDEX ИНДЕКС	POŁOŻENIE* LOCATION* РАСПОЛОЖЕНИЕ	ZASTOSOWANIE APPLICATION ПРИЛОЖЕНИЕ	REFERENCJE REFERENCES ПРОИЗВОДИТЕЛЬ	ZDJĘCIE PHOTO ФОТО	
WPB-1.1532	TP	WPS-1.1530	CITROEN Jumper Realy FIAT Ducato PEUGEOT Boxer	LUCAS	
WPB-1.1533	TL	WPS-1.1531			
WPB-1.1653	TP	WPS-1.1651	OPEL Agila	OPEL	
WPB-1.1654	TL	WPS-1.1652			
WPB-1.1713	TP	WPS-1.1711	TOYOTA Corolla	SUMITAMO	
WPB-1.1714	TL	WPS-1.1712			
WPB-1.1723	TP	WPS-1.1721	TOYOTA RAV 4 II	SUMITAMO	
WPB-1.1724	TL	WPS-1.1722			
WPB-1.1733	TP	WPS-1.1731	TOYOTA Yaris Yaris Verso	TOYOTA	
WPB-1.1734	TL	WPS-1.1732			

* - TP = Tył prawy / Rear right / Зад Правый, TL = Tył lewy / Rear left / Зад Левый

INDEKS INDEX ИНДЕКС	POŁOŻENIE* LOCATION РАСПОЛОЖЕНИЕ	ZASTOSOWANIE APPLICATION ПРИЛОЖЕНИЕ	REFERENCJE REFERENCES ПРОИЗВОДИТЕЛЬ	ZDJĘCIE PHOTO ФОТО
WPB-1.1813	TP	WPS-1.1811	HYUNDAI Accent (X-3) Atos Exel Getz(TB) Pony (X-2)	
WPB-1.1814	TL	WPS-1.1812		
WPB-1.F052	TP	WPS-1.F050	FORD Transit	
WPB-1.F053	TL	WPS-1.F051		

* - TP = Tył prawy / Rear right / Зад Правый, TL = Tył lewy / Rear left / Зад Левый

MARKA/MODEL BRAND/MODEL МАРКА АВТОМОБИЛЯ	INDEKS INDEX ИНДЕКС	POŁOŻENIE* LOCATION РАСПОЛОЖЕНИЕ	REFERENCJE REFERENCES ПРОИЗВОДИТЕЛЬ	ZASTOSOWANIE APPLICATION ПРИЛОЖЕНИЕ	MARKA/MODEL BRAND/MODEL МАРКА АВТОМОБИЛЯ	INDEKS INDEX ИНДЕКС	POŁOŻENIE* LOCATION РАСПОЛОЖЕНИЕ	REFERENCJE REFERENCES ПРОИЗВОДИТЕЛЬ	ZASTOSOWANIE APPLICATION ПРИЛОЖЕНИЕ
CITROEN					PEUGEOT				
C2	WPB-1.1395	TL	LUCAS	WPS-1.1399	05 kombi	WPB-1.1314	TP	LUCAS	WPS-1.1358
C2	WPB-1.1396	TP	LUCAS	WPS-1.1398	05 kombi	WPB-1.1315	TL	LUCAS	WPS-1.1359
C3	WPB-1.1395	TL	LUCAS	WPS-1.1399	205	WPB-1.963	TP	LUCAS	WPS-1.1076
C3	WPB-1.1396	TP	LUCAS	WPS-1.1398	205	WPB-1.964	TP	LUCAS	WPS-1.1077
Jumper	WPB-1.1403	TL	LUCAS	WPS-1.1401	306	WPB-1.963	TP	LUCAS	WPS-1.1076
Jumper	WPB-1.1404	TP	LUCAS	WPS-1.1402	306	WPB-1.964	TP	LUCAS	WPS-1.1077
Jumper	WPB-1.1532	TP	LUCAS	WPS-1.1530	306(N5)	WPB-1.963	TP	LUCAS	WPS-1.1076
Jumper	WPB-1.1533	TL	LUCAS	WPS-1.1531	306(N5)	WPB-1.964	TP	LUCAS	WPS-1.1077
Realy	WPB-1.1403	TL	LUCAS	WPS-1.1401	309	WPB-1.963	TP	LUCAS	WPS-1.1076
Realy	WPB-1.1404	TP	LUCAS	WPS-1.1402	309	WPB-1.964	TP	LUCAS	WPS-1.1077
Realy	WPB-1.1532	TP	LUCAS	WPS-1.1530	405	WPB-16.1173	TL	BENDIX	WPS-1.1129
Realy	WPB-1.1533	TL	LUCAS	WPS-1.1531	405	WPB-16.1174	TP	BENDIX	WPS-1.1130
Xsara	WPB-1.963	TP	LUCAS	WPS-1.1076	1007	WPB-1.1395	TL	LUCAS	WPS-1.1399
Xsara	WPB-1.964	TL	LUCAS	WPS-1.1077	1007	WPB-1.1396	TP	LUCAS	WPS-1.1398
ZX	WPB-1.963	TP	LUCAS	WPS-1.1076	Boxer	WPB-1.1403	TL	LUCAS	WPS-1.1401
ZX	WPB-1.964	TL	LUCAS	WPS-1.1077	Boxer	WPB-1.1404	TP	LUCAS	WPS-1.1402
DAEWOO					Boxer	WPB-1.1532	TP	LUCAS	WPS-1.1530
Matiz	WPB-1.1088	TP	DAEWOO	WPS-1.1052	Boxer	WPB-1.1533	TL	LUCAS	WPS-1.1531
Matiz	WPB-1.1089	TL	DAEWOO	WPS-1.1053	Partner	WPB-1.1314	TP	LUCAS	WPS-1.1358
FIAT					Partner	WPB-1.1315	TL	LUCAS	WPS-1.1359
Ducato	WPB-1.1403	TL	LUCAS	WPS-1.1401	RENAULT				
Ducato	WPB-1.1404	TP	LUCAS	WPS-1.1402	19 RT	WPB-16.1173	TL	BENDIX	WPS-1.1129
Ducato	WPB-1.1532	TP	LUCAS	WPS-1.1530	19 RT	WPB-16.1174	TP	BENDIX	WPS-1.1130
Ducato	WPB-1.1533	TL	LUCAS	WPS-1.1531	Clio	WPB-1.1126	TP	VARGA	WPS-1.1072
Palio	WPB-1.1286	TP	ATE	WPS-1.1284	Clio	WPB-1.1127	TL	VARGA	WPS-1.1073
Palio	WPB-1.1287	TL	ATE	WPS-1.1285	Espace II	WPB-1.1080	TP	LUCAS	WPS-1.1078
Siena	WPB-1.1286	TP	ATE	WPS-1.1284	Espace II	WPB-1.1081	TL	LUCAS	WPS-1.1079
Siena	WPB-1.1287	TL	ATE	WPS-1.1285	Express/Rapid	WPB-1.1080	TP	LUCAS	WPS-1.1078
FORD					Express/Rapid	WPB-1.1081	TL	LUCAS	WPS-1.1079
FORD Transit	WPB-1.F052	TP	BOSCH	WPS-1.F050	Laguna	WPB-1.1314	TP	LUCAS	WPS-1.1400
FORD Transit	WPB-1.F053	TL	BOSCH	WPS-1.F051	Laguna	WPB-1.1315	TL	LUCAS	WPS-1.1399
HYUNDAI					Laguna	WPB-1.1395	TL	LUCAS	WPS-1.1399
Accent (X-3)	WPB-1.1814	TL	SUMITAMO	WPS-1.1812	Laguna	WPB-1.1396	TP	LUCAS	WPS-1.1398
Accent (X-3)	WPB-1.1813	TP	SUMITAMO	WPS-1.1811	Megane I	WPB-1.1314	TP	LUCAS	WPS-1.1400
Atos	WPB-1.1814	TL	MANDO	WPS-1.1812	Megane I	WPB-1.1315	TL	LUCAS	WPS-1.1399
Atos	WPB-1.1813	TP	MANDO	WPS-1.1811	Scenic	WPB-1.1314	TP	LUCAS	WPS-1.1400
Exel	WPB-1.1814	TL	SUMITAMO	WPS-1.1812	Scenic	WPB-1.1315	TL	LUCAS	WPS-1.1399
Exel	WPB-1.1813	TP	SUMITAMO	WPS-1.1811	TOYOTA				
Getz (TB)	WPB-1.1814	TL	MANDO	WPS-1.1812	Carina E	WPB-1.1395	TL	LUCAS	WPS-1.1633
Getz (TB)	WPB-1.1813	TP	MANDO	WPS-1.1811	Carina E	WPB-1.1396	TP	LUCAS	WPS-1.1631
Pony (X-2)	WPB-1.1814	TL	SUMITAMO	WPS-1.1812	Corolla	WPB-1.1713	TP	SUMITAMO	WPS-1.1711
Pony (X-2)	WPB-1.1813	TP	SUMITAMO	WPS-1.1811	Corolla	WPB-1.1714	TL	SUMITAMO	WPS-1.1712
MERCEDES					Corolla	WPB-1.1395	TL	LUCAS	WPS-1.1633
180D	WPB-1.1084	TP	LUCAS	WPS-1.1082	Corolla	WPB-1.1396	TP	LUCAS	WPS-1.1631
180D	WPB-1.1085	TL	LUCAS	WPS-1.1083	RAV 4 II	WPB-1.1723	TP	SUMITAMO	WPS-1.1721
W 168	WPB-1.1395	TL	LUCAS	WPS-1.1622	RAV 4 II	WPB-1.1724	TL	SUMITAMO	WPS-1.1722
W 168	WPB-1.1396	TP	LUCAS	WPS-1.1621	Yaris	WPB-1.1734	TL	TOYOTA	WPS-1.1732
NISSAN					Yaris	WPB-1.1733	TP	TOYOTA	WPS-1.1731
Micra	WPB-1.1395	TL	LUCAS	WPS-1.1642	Yaris Verso	WPB-1.1734	TL	TOYOTA	WPS-1.1732
Micra	WPB-1.1396	TP	LUCAS	WPS-1.1641	Yaris Verso	WPB-1.1733	TP	TOYOTA	WPS-1.1731
OPEL									
Agila	WPB-1.1653	TP	Opel	WPS-1.1651					
Agila	WPB-1.1654	TL	Opel	WPS-1.1652					
Astra	WPB-1.1088	TP	OPEL	WPS-1.1086					
Astra	WPB-1.1089	TL	OPEL	WPS-1.1087					
Astra G	WPB-1.1088	TP	LUCAS	WPS-1.1611					
Astra G	WPB-1.1089	TL	LUCAS	WPS-1.1612					
Corsa	WPB-1.1088	TP	OPEL	WPS-1.1086					
Corsa	WPB-1.1089	TL	OPEL	WPS-1.1087					
Tigra	WPB-1.1088	TP	OPEL	WPS-1.1086					
Tigra	WPB-1.1089	TL	OPEL	WPS-1.1087					
Vectra B	WPB-1.1088	TP	LUCAS	WPS-1.1611					
Vectra B	WPB-1.1089	TL	LUCAS	WPS-1.1612					
Zafira	WPB-1.1088	TP	LUCAS	WPS-1.1611					
Zafira	WPB-1.1089	TL	LUCAS	WPS-1.1612					

* - TP = Tył prawy / Rear right / Зад Правый, TL = Tył lewy / Rear left / Зад Левый

Przewody hamulcowe
posortowane według indeksu „WP”

Brake lines

sorted by „WP” index

Выбор тормозных трубок
по коду WP

INDEKS
INDEX
ИНДЕКС

ZŁĄCZKA
FITTING
НАКОНЕЧНИК

ZŁĄCZKA
FITTING
НАКОНЕЧНИК

DŁUGOŚĆ W MM
LENGHT IN MM
ДЛИНА В ММ

ŚREDNICA RURY
DIAMETER
ДИАМЕТР ТРУБЫ

INDEKS
INDEX
ИНДЕКС

ZŁĄCZKA
FITTING
НАКОНЕЧНИК

ZŁĄCZKA
FITTING
НАКОНЕЧНИК

DŁUGOŚĆ W MM
LENGHT IN MM
ДЛИНА В ММ

ŚREDNICA RURY
DIAMETER
ДИАМЕТР ТРУБЫ



WP-001

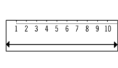
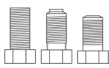

WP-001

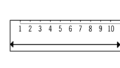
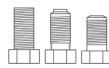
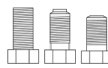

INDEKS INDEX ИНДЕКС	ZŁĄCZKA FITTING НАКОНЕЧНИК	ZŁĄCZKA FITTING НАКОНЕЧНИК	DŁUGOŚĆ W MM LENGHT IN MM ДЛИНА В ММ	ŚREDNICA RURY DIAMETER ДИАМЕТР ТРУБЫ
WP-001	105	105	300	4,75
WP-002	105	105	850	4,75
WP-003	105	105	1400	4,75
WP-004	105	105	3100	4,75
WP-005	105	105	450	4,75
WP-006	105	105	250	4,75
WP-007	105	105	3900	4,75
WP-008	105	105	3000	4,75
WP-009	105	105	600	4,75
WP-010	105	105	1850	4,75
WP-011	105	105	2300	4,75
WP-012	105	105	1650	4,75
WP-013	105	105	900	4,75
WP-014	105	105	2400	4,75
WP-015	105	105	2700	4,75
WP-016	105	105	2900	4,75
WP-017	105	105	500	4,75
WP-018	105	105	650	4,75
WP-019	105	105	1000	4,75
WP-020	105	105	3400	4,75
WP-021	105	105	3600	4,75
WP-022	105	105	1350	4,75
WP-023	105	105	1800	4,75
WP-024	105	105	800	4,75
WP-025	105	105	4300	4,75
WP-026	105	105	4400	4,75
WP-027	105	105	1250	4,75
WP-028	105	105	550	4,75
WP-029	105	105	3200	4,75
WP-030	105	105	3700	4,75
WP-031	105	105	2200	4,75
WP-032	105	105	2800	4,75
WP-033	105	105	700	4,75
WP-034	105	105	1200	4,75
WP-035	105	105	1100	4,75
WP-036	105	105	2100	4,75
WP-037	105	107	800	4,75
WP-038	105	105	3800	4,75
WP-039	105	105	1550	4,75
WP-040	105	105	3300	4,75
WP-041	105	105	350	4,75
WP-042	105	105	1700	4,75
WP-043	105	105	200	4,75
WP-044	105	105	4800	4,75
WP-045	105	105	400	4,75
WP-046	105	105	3500	4,75
WP-047	105	105	1500	4,75
WP-048	105	105	2500	4,75
WP-049	105	105	1900	4,75
WP-050	105	105	4100	4,75
WP-051	112	112	550	4,75
WP-052	112	112	1050	4,75
WP-053	112	112	500	4,75
WP-054	112	112	900	4,75
WP-055	112	112	2100	4,75
WP-056	112	112	300	4,75
WP-057	109	109	1100	4,75
WP-058	109	109	450	4,75
WP-059	109	110	650	4,75
WP-060	109	110	150	4,75
WP-061	109	110	300	4,75
WP-062	109	109	2600	4,75
WP-063	109	110	700	4,75
WP-064	109	110	200	4,75
WP-065	109	109	800	4,75
WP-066	109	114	450	4,75
WP-067	109	110	2500	4,75
WP-068	110	114	3000	4,75
WP-069	109	114	2600	4,75
WP-070	116	116	200	4,75
WP-071	109	114	3100	4,75
WP-072	109	110	1500	4,75
WP-073	109	110	550	4,75
WP-074	109	110	1100	4,75
WP-075	109	109	1700	4,75
WP-076	109	110	1350	4,75
WP-077	109	110	1750	4,75
WP-078	109	110	800	4,75
WP-079	109	109	1400	4,75
WP-080	109	110	3300	4,75
WP-081	110	114	1400	4,75
WP-082	110	114	850	4,75
WP-083	109	110	3500	4,75

INDEKS INDEX ИНДЕКС	ZŁĄCZKA FITTING НАКОНЕЧНИК	ZŁĄCZKA FITTING НАКОНЕЧНИК	DŁUGOŚĆ W MM LENGHT IN MM ДЛИНА В ММ	ŚREDNICA RURY DIAMETER ДИАМЕТР ТРУБЫ
WP-084	109	110	900	4,75
WP-085	109	110	450	4,75
WP-086	109	110	750	4,75
WP-087	109	109	3200	4,75
WP-088	105	106	150	4,75
WP-089	104	106	950	4,75
WP-090	105	106	650	4,75
WP-091	105	106	250	4,75
WP-092	104	106	2700	4,75
WP-093	105	106	3000	4,75
WP-094	109	110	1200	4,75
WP-095	109	110	600	4,75
WP-096	109	110	2300	4,75
WP-097	109	110	850	4,75
WP-098	109	110	1000	4,75
WP-099	110	114	750	4,75
WP-100	116	116	2300	4,75
WP-101	105	106	200	4,75
WP-102	105	106	800	4,75
WP-103	104	106	1400	4,75
WP-104	105	106	1000	4,75
WP-105	104	106	750	4,75
WP-106	106	106	2300	4,75
WP-107	105	106	1300	4,75
WP-108	105	106	400	4,75
WP-109	105	106	1100	4,75
WP-110	105	106	550	4,75
WP-111	105	106	300	4,75
WP-112	105	106	1550	4,75
WP-113	105	106	1850	4,75
WP-114	105	106	350	4,75
WP-115	105	105	1150	4,75
WP-116	106	106	2400	4,75
WP-117	105	105	750	4,75
WP-118	116	116	300	4,75
WP-119	116	116	950	4,75
WP-120	116	116	550	4,75
WP-121	116	116	2800	4,75
WP-122	116	116	3700	4,75
WP-123	116	116	450	4,75
WP-124	116	116	1350	4,75
WP-125	116	116	750	4,75
WP-126	116	116	900	4,75
WP-127	116	116	2600	4,75
WP-128	116	116	3600	4,75
WP-129	116	116	1200	4,75
WP-130	116	116	250	4,75
WP-131	116	116	700	4,75
WP-132	116	116	1050	4,75
WP-133	116	116	1100	4,75
WP-134	116	116	500	4,75
WP-135	116	116	150	4,75
WP-136	116	116	850	4,75
WP-137	116	116	2400	4,75
WP-138	116	116	350	4,75
WP-139	116	116	3100	4,75
WP-140	116	116	1500	4,75
WP-141	116	116	600	4,75
WP-142	116	116	2500	4,75
WP-143	116	116	3300	4,75
WP-144	116	116	400	4,75
WP-145	116	116	1850	4,75
WP-146	116	116	2100	4,75
WP-147	116	116	2000	4,75
WP-148	116	116	800	4,75
WP-149	112	112	1100	4,75
WP-150	112	112	400	4,75
WP-151	112	112	350	4,75
WP-152	112	112	1250	4,75
WP-153	112	112	650	4,75
WP-154	112	112	950	4,75
WP-155	112	112	3500	4,75
WP-156	112	112	1700	4,75
WP-157	112	112	3000	4,75
WP-158	112	112	3600	4,75
WP-159	112	112	850	4,75
WP-160	112	112	1150	4,75
WP-161	112	112	2400	4,75
WP-162	112	112	450	4,75
WP-163	112	112	1450	4,75
WP-164	112	112	2300	4,75
WP-165	112	112	1400	4,75
WP-166	112	112	3300	4,75

INDEKS
INDEX
ИНДЕКС

ZŁĄCZKA
FITTING
НАКОНЕЧНИК

ZŁĄCZKA
FITTING
НАКОНЕЧНИК

DŁUGOŚĆ W MM
LENGHT IN MM
ДЛИНА В ММ

ŚREDNICA RURY
DIAMETER
ДИАМЕТР ТРУБЫ

INDEKS
INDEX
ИНДЕКС

ZŁĄCZKA
FITTING
НАКОНЕЧНИК

ZŁĄCZKA
FITTING
НАКОНЕЧНИК

DŁUGOŚĆ W MM
LENGHT IN MM
ДЛИНА В ММ

ŚREDNICA RURY
DIAMETER
ДИАМЕТР ТРУБЫ

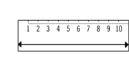
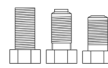
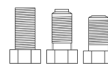
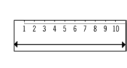
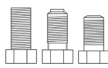
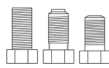

INDEKS INDEX ИНДЕКС	ZŁĄCZKA FITTING НАКОНЕЧНИК	ZŁĄCZKA FITTING НАКОНЕЧНИК	DŁUGOŚĆ W MM LENGHT IN MM ДЛИНА В ММ	ŚREDNICA RURY DIAMETER ДИАМЕТР ТРУБЫ
WP-167	105	105	2600	4,75
WP-168	112	112	1600	4,75
WP-169	109	110	250	4,75
WP-170	109	110	3200	4,75
WP-171	110	114	250	4,75
WP-172	110	114	1500	4,75
WP-173	109	110	3000	4,75
WP-174	105	106	750	4,75
WP-175	105	106	2000	4,75
WP-176	105	106	3700	4,75
WP-177	109	110	1300	4,75
WP-178	109	110	350	4,75
WP-179	109	109	1300	4,75
WP-180	109	110	400	4,75
WP-181	109	110	2800	4,75
WP-182	110	110	2300	4,75
WP-183	109	110	1150	4,75
WP-184	109	110	3600	4,75
WP-185	110	114	1200	4,75
WP-186	105	106	1150	4,75
WP-187	105	106	2200	4,75
WP-188	105	106	1250	4,75
WP-189	106	109	500	4,75
WP-190	105	106	1700	4,75
WP-191	105	106	3100	4,75
WP-192	105	106	3400	4,75
WP-193	105	106	2100	4,75
WP-194	105	106	1400	4,75
WP-195	105	106	700	4,75
WP-196	105	105	1300	4,75
WP-197	105	106	1750	4,75
WP-198	105	106	1350	4,75
WP-199	105	106	900	4,75
WP-200	105	106	1900	4,75
WP-201	104	106	4000	4,75
WP-202	104	106	3500	4,75
WP-203	105	106	4000	4,75
WP-204	105	106	3500	4,75
WP-205	105	105	150	4,75
WP-206	104	105	100	4,75
WP-207	105	106	1600	4,75
WP-208	104	105	3100	4,75
WP-209	104	105	3000	4,75
WP-210	104	105	1550	4,75
WP-211	106	106	450	4,75
WP-212	106	106	1850	4,75
WP-213	105	107	3300	4,75
WP-214	106	106	600	4,75
WP-215	104	105	3200	4,75
WP-216	105	106	1450	4,75
WP-217	104	106	300	4,75
WP-218	116	116	1800	4,75
WP-219	116	116	4100	4,75
WP-220	116	116	1700	4,75
WP-221	116	116	3500	4,75
WP-222	116	116	1650	4,75
WP-223	116	116	1550	4,75
WP-224	116	116	1450	4,75
WP-225	116	116	3900	4,75
WP-226	112	112	3100	4,75
WP-227	112	112	1850	4,75
WP-228	112	112	750	4,75
WP-229	112	112	250	4,75
WP-230	113	113	700	4,75
WP-231	113	113	1100	4,75
WP-232	113	113	3000	4,75
WP-233	113	113	850	4,75
WP-234	113	113	550	4,75
WP-235	116	116	2200	4,75
WP-236	116	116	3200	4,75
WP-237	113	113	300	4,75
WP-238	113	113	350	4,75
WP-239	113	113	1200	4,75
WP-240	113	113	650	4,75
WP-241	113	113	2400	4,75
WP-242	113	113	1050	4,75
WP-243	113	113	450	4,75
WP-244	113	113	1000	4,75
WP-245	113	113	2600	4,75
WP-246	113	113	200	4,75
WP-247	113	113	1950	4,75
WP-248	113	113	1600	4,75
WP-249	113	113	2900	4,75

INDEKS INDEX ИНДЕКС	ZŁĄCZKA FITTING НАКОНЕЧНИК	ZŁĄCZKA FITTING НАКОНЕЧНИК	DŁUGOŚĆ W MM LENGHT IN MM ДЛИНА В ММ	ŚREDNICA RURY DIAMETER ДИАМЕТР ТРУБЫ
WP-250	116	116	1900	4,75
WP-251	116	116	1600	4,75
WP-252	105	105	1050	4,75
WP-253	105	105	4200	4,75
WP-254	104	105	1150	4,75
WP-255	104	105	3600	4,75
WP-256	105	105	1750	4,75
WP-257	105	105	4500	4,75
WP-258	104	105	450	4,75
WP-259	104	105	4800	4,75
WP-260	104	105	850	4,75
WP-261	104	105	600	4,75
WP-262	104	105	4500	4,75
WP-263	104	104	4800	4,75
WP-264	104	105	750	4,75
WP-265	105	105	950	4,75
WP-266	104	105	1900	4,75
WP-267	115	115	900	4,75
WP-268	115	115	1300	4,75
WP-269	115	115	400	4,75
WP-270	115	115	500	4,75
WP-271	115	115	1850	4,75
WP-272	115	115	350	4,75
WP-273	115	115	600	4,75
WP-274	115	115	2500	4,75
WP-275	115	115	1050	4,75
WP-276	115	115	2300	4,75
WP-277	115	115	650	4,75
WP-278	115	115	750	4,75
WP-279	109	115	300	4,75
WP-280	115	115	950	4,75
WP-281	114	115	2300	4,75
WP-282	115	115	450	4,75
WP-283	104	105	550	4,75
WP-284	104	105	300	4,75
WP-285	109	109	1550	4,75
WP-286	109	109	150	4,75
WP-287	109	109	600	4,75
WP-288	109	109	2800	4,75
WP-289	109	114	950	4,75
WP-290	109	114	1950	4,75
WP-291	109	109	2900	4,75
WP-292	109	109	3000	4,75
WP-293	109	109	950	4,75
WP-294	109	109	1950	4,75
WP-295	109	114	3000	4,75
WP-296	109	109	700	4,75
WP-297	109	109	2100	4,75
WP-298	109	109	300	4,75
WP-299	109	109	3300	4,75
WP-300	109	109	750	4,75
WP-301	109	109	1150	4,75
WP-302	109	109	1800	4,75
WP-303	104	109	3100	4,75
WP-304	109	109	3500	4,75
WP-305	109	109	1450	4,75
WP-306	109	114	3600	4,75
WP-307	104	109	3200	4,75
WP-308	104	105	3700	4,75
WP-309	104	105	700	4,75
WP-310	104	105	2800	4,75
WP-311	109	109	3600	4,75
WP-312	104	105	5000	4,75
WP-313	104	105	4900	4,75
WP-314	104	105	1000	4,75
WP-315	104	105	1950	4,75
WP-316	104	105	5400	4,75
WP-317	109	109	200	4,75
WP-318	109	110	1950	4,75
WP-319	109	109	900	4,75
WP-320	109	110	1600	4,75
WP-321	109	109	1000	4,75
WP-322	109	109	350	4,75
WP-323	109	110	950	4,75
WP-324	109	110	2400	4,75
WP-325	109	110	1450	4,75
WP-326	109	110	2200	4,75
WP-327	109	109	1200	4,75
WP-328	105	106	3200	4,75
WP-329	109	109	2200	4,75
WP-330	109	109	1900	4,75
WP-331	105	105	2000	4,75
WP-332	109	110	1850	4,75

INDEKS
INDEX
ИНДЕКС

ZŁĄCZKA
FITTING
НАКОНЕЧНИК

ZŁĄCZKA
FITTING
НАКОНЕЧНИК

DŁUGOŚĆ W MM
LENGHT IN MM
ДЛИНА В ММ

ŚREDNICA RURY
DIAMETER
ДИАМЕТР ТРУБЫ

INDEKS
INDEX
ИНДЕКС

ZŁĄCZKA
FITTING
НАКОНЕЧНИК

ZŁĄCZKA
FITTING
НАКОНЕЧНИК

DŁUGOŚĆ W MM
LENGHT IN MM
ДЛИНА В ММ

ŚREDNICA RURY
DIAMETER
ДИАМЕТР ТРУБЫ



WP- 001

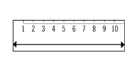
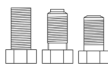

WP- 001

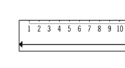
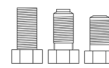
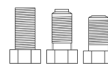

INDEKS INDEX ИНДЕКС	ZŁĄCZKA FITTING НАКОНЕЧНИК	ZŁĄCZKA FITTING НАКОНЕЧНИК	DŁUGOŚĆ W MM LENGHT IN MM ДЛИНА В ММ	ŚREDNICA RURY DIAMETER ДИАМЕТР ТРУБЫ
WP-333	109	110	500	4,75
WP-334	110	114	1750	4,75
WP-335	110	114	300	4,75
WP-336	109	109	1500	4,75
WP-337	105	110	1650	4,75
WP-338	105	110	250	4,75
WP-339	105	110	2500	4,75
WP-340	115	115	700	4,75
WP-341	115	115	250	4,75
WP-342	115	115	550	4,75
WP-343	115	115	2700	4,75
WP-344	115	115	2200	4,75
WP-345	115	115	1550	4,75
WP-346	105	116	900	4,75
WP-347	105	116	3500	4,75
WP-348	105	116	4500	4,75
WP-349	105	116	3700	4,75
WP-350	105	116	4600	4,75
WP-351	105	116	1450	4,75
WP-352	105	116	3800	4,75
WP-353	105	116	950	4,75
WP-354	105	116	350	4,75
WP-355	105	116	1150	4,75
WP-356	105	105	1450	4,75
WP-357	105	116	150	4,75
WP-358	105	105	4000	4,75
WP-359	111	115	350	4,75
WP-360	111	115	300	4,75
WP-361	111	115	800	4,75
WP-362	111	115	500	4,75
WP-363	111	115	950	4,75
WP-364	115	115	2800	4,75
WP-365	115	115	3000	4,75
WP-366	115	115	1000	4,75
WP-367	115	115	800	4,75
WP-368	115	115	1100	4,75
WP-369	115	115	200	4,75
WP-370	109	111	300	4,75
WP-371	109	111	800	4,75
WP-372	109	111	950	4,75
WP-373	109	111	700	4,75
WP-374	111	115	700	4,75
WP-375	111	111	250	4,75
WP-376	111	115	400	4,75
WP-377	111	115	1050	4,75
WP-378	111	115	550	4,75
WP-379	111	115	1700	4,75
WP-380	111	115	1850	4,75
WP-381	111	115	1100	4,75
WP-382	111	115	900	4,75
WP-383	111	115	850	4,75
WP-384	105	106	500	4,75
WP-385	105	106	450	4,75
WP-386	105	106	1050	4,75
WP-387	105	106	1200	4,75
WP-388	105	108	450	4,75
WP-389	105	108	1050	4,75
WP-390	105	105	2250	4,75
WP-391	105	105	5800	4,75
WP-392	105	105	5000	4,75
WP-393	106	106	150	4,75
WP-394	105	112	550	4,75
WP-395	105	112	1100	4,75
WP-396	105	106	600	4,75
WP-397	105	112	4000	4,75
WP-398	104	105	2100	4,75
WP-399	104	105	2300	4,75
WP-400	104	105	2500	4,75
WP-401	104	105	2700	4,75
WP-402	109	109	400	4,75
WP-403	105	112	900	4,75
WP-404	105	105	2550	4,75
WP-405	104	105	4000	4,75
WP-406	116	116X	300	4,75
WP-407	109	109	500	4,75
WP-408	104	104	700	4,75
WP-409	112	112	1750	4,75
WP-410	112	112	1000	4,75
WP-411	112	112	800	4,75
WP-412	112	112	600	4,75
WP-413	112	112	3700	4,75
WP-414	105	112	3500	4,75
WP-415	105	112	200	4,75

INDEKS INDEX ИНДЕКС	ZŁĄCZKA FITTING НАКОНЕЧНИК	ZŁĄCZKA FITTING НАКОНЕЧНИК	DŁUGOŚĆ W MM LENGHT IN MM ДЛИНА В ММ	ŚREDNICA RURY DIAMETER ДИАМЕТР ТРУБЫ
WP-416	105	118	900	4,75
WP-417	105	118	2400	4,75
WP-418	105	118	1100	4,75
WP-419	105	118	1600	4,75
WP-420	105	112	2000	4,75
WP-421	112	112	1200	4,75
WP-422	112	112	1300	4,75
WP-423	118	118	750	4,75
WP-424	118	118	1300	4,75
WP-425	118	118	1050	4,75
WP-426	118	118	650	4,75
WP-427	118	118	3700	4,75
WP-428	105	105	2050	4,75
WP-429	116	116	1000	4,75
WP-430	116	116	4200	4,75
WP-431	116	116	650	4,75
WP-432	105	105	3250	4,75
WP-433	105	105	2950	4,75
WP-434	116	116	4000	4,75
WP-435	105	105	1600	4,75
WP-436	105	105	4900	4,75
WP-437	104	105	4100	4,75
WP-438	105	105	4450	4,75
WP-439	104	105	2900	4,75
WP-440	105	105	2150	4,75
WP-441	104	105	500	4,75
WP-442	105	107	1000	4,75
WP-443	105	107	550	4,75
WP-444	105	106	950	4,75
WP-445	105	106	2300	4,75
WP-446	105	106	3300	4,75
WP-447	105	106	3600	4,75
WP-448	105	106	850	4,75
WP-449	116	116	3800	4,75
WP-450	116	116	5700	4,75
WP-451	104	105	4700	4,75
WP-452	104	105	4300	4,75
WP-453	104	105	250	4,75
WP-454	106	106	3200	4,75
WP-455	105	106	2400	4,75
WP-456	105	106	2600	4,75
WP-457	104	105	400	4,75
WP-458	104	106	2400	4,75
WP-459	105	106	1500	4,75
WP-460	104	106	2500	4,75
WP-461	105	116	1100	4,75
WP-462	105	116	2100	4,75
WP-463	105	116	1350	4,75
WP-464	105	112	2200	4,75
WP-465	105	112	150	4,75
WP-466	112	112	1800	4,75
WP-467	112	112	4100	4,75
WP-468	112	112	4350	4,75
WP-469	112	112	2500	4,75
WP-470	112	112	2850	4,75
WP-471	105	109	1900	4,75
WP-472	105	109	200	4,75
WP-473	105	109	250	4,75
WP-474	105	109	300	4,75
WP-475	105	105	3050	4,75
WP-476	105	105	4700	4,75
WP-477	104	106	200	4,75
WP-478	105	105	130	4,75
WP-479	104	105	1200	4,75
WP-480	104	105	1500	4,75
WP-481	104	105	800	4,75
WP-482	105	105	1950	4,75
WP-483	104	105	1750	4,75
WP-484	104	105	2000	4,75
WP-485	104	105	1350	4,75
WP-486	104	105	1850	4,75
WP-487	104	105	200	4,75
WP-488	104	105	1700	4,75
WP-489	104	105	1100	4,75
WP-490	104	105	350	4,75
WP-491	104	105	1800	4,75
WP-492	104	105	1250	4,75
WP-493	105	105X	1250	4,75
WP-494	104	105	1600	4,75
WP-495	104	105	1300	4,75
WP-496	104	105	1050	4,75
WP-497	104	105	1450	4,75
WP-498	104	105	1650	4,75

INDEKS
INDEX
ИНДЕКС

ZŁĄCZKA
FITTING
НАКОНЕЧНИК

ZŁĄCZKA
FITTING
НАКОНЕЧНИК

DŁUGOŚĆ W MM
LENGHT IN MM
ДЛИНА В ММ

ŚREDNICA RURY
DIAMETER
ДИАМЕТР ТРУБЫ

INDEKS
INDEX
ИНДЕКС

ZŁĄCZKA
FITTING
НАКОНЕЧНИК

ZŁĄCZKA
FITTING
НАКОНЕЧНИК

DŁUGOŚĆ W MM
LENGHT IN MM
ДЛИНА В ММ

ŚREDNICA RURY
DIAMETER
ДИАМЕТР ТРУБЫ

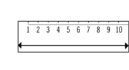
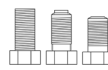
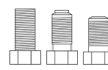
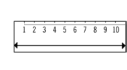
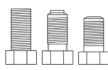
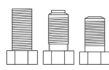

WP-499	104	105	650	4,75
WP-500	104	105	1400	4,75
WP-501	104	105	900	4,75
WP-502	104	104	600	4,75
WP-503	104	106	3300	4,75
WP-504	104	116	700	4,75
WP-505	105	104X	600	4,75
WP-506	105	104X	1250	4,75
WP-507	104X	104X	600	4,75
WP-508	110X	110X	2100	4,75
WP-509	116	116	2850	4,75
WP-510	104	104	4300	4,75
WP-511	104X	110X	600	4,75
WP-512	104	106	900	4,75
WP-513	104	105	2250	4,75
WP-514	105	104X	2950	4,75
WP-515	105	116	750	4,75
WP-516	106	106	3000	4,75
WP-517	105	106	3200	4,75
WP-518	104	116	1800	4,75
WP-519	105	110X	2900	4,75
WP-520	105	106	1950	4,75
WP-521	104	106	1200	4,75
WP-522	104X	104X	650	4,75
WP-523	105	104X	1000	4,75
WP-524	104	106	1300	4,75
WP-525	105	110X	3000	4,75
WP-526	105	106	2750	4,75
WP-527	105	116	2150	4,75
WP-528	105	104X	1350	4,75
WP-529	105	106	2800	4,75
WP-530	105	116	3250	4,75
WP-531	105	104X	3000	4,75
WP-532	104	104	3000	4,75
WP-533	105	105	2750	4,75
WP-534	105	105	3750	4,75
WP-535	105	112	1300	4,75
WP-536	105	112	750	4,75
WP-537	105	112	3800	4,75
WP-538	105	112	1050	4,75
WP-539	105	112	650	4,75
WP-540	104	104	200	4,75
WP-541	104	104	900	4,75
WP-542	104	104	2200	4,75
WP-543	104	104	1250	4,75
WP-544	104	105	950	4,75
WP-545	104	104	3400	4,75
WP-546	104	104	750	4,75
WP-547	104	105	3500	4,75
WP-548	104	104	500	4,75
WP-549	104	104	1000	4,75
WP-550	104	104	1500	4,75
WP-551	112	112	1500	4,75
WP-552	104	104	2000	4,75
WP-553	112	112	2000	4,75
WP-554	104	104	2500	4,75
WP-555	105	105	180	4,75
WP-556	105	105X	700	4,75
WP-557	105	105X	1100	4,75
WP-558	105	105X	500	4,75
WP-559	105	105	2350	4,75
WP-560	105	106	2050	4,75
WP-561	104	106	1000	4,75
WP-562	104	106	1600	4,75
WP-563	105	106	2500	4,75
WP-564	106	106	3100	4,75
WP-565	104	106	600	4,75
WP-566	105	106	3250	4,75
WP-567	116	116	3550	4,75
WP-568	116	116	4150	4,75
WP-569	116	116	4050	4,75
WP-570	116	116	4500	4,75
WP-571	105	105	3850	4,75
WP-572	105	106	3950	4,75
WP-573	106	106	200	4,75
WP-574	107	116	200	4,75
WP-575	112	112	150	4,75
WP-576	104	104	250	4,75
WP-577	104	104	450	4,75
WP-578	105	116	300	4,75
WP-579	105	116	400	4,75
WP-580	105	116	1300	4,75
WP-581	116	116	1400	4,75

WP-582	104	104	550	4,75
WP-583	104	104	1900	4,75
WP-584	104	105	2200	4,75
WP-585	104	105	2650	4,75
WP-586	104	105	2750	4,75
WP-587	104	105	2950	4,75
WP-588	104	105	3050	4,75
WP-589	104	105	3150	4,75
WP-590	104	105	3300	4,75
WP-591	104	105	3450	4,75
WP-592	104	105	3850	4,75
WP-593	104	105	4250	4,75
WP-594	104	105	4450	4,75
WP-595	104	105	4750	4,75
WP-596	104	105	5350	4,75
WP-597	104	106	1450	4,75
WP-598	104	106	1550	4,75
WP-599	104	106	2100	4,75
WP-600	103	103	1700	6,35
WP-601	103	103	1000	6,35
WP-602	103	103	1300	6,35
WP-603	103	103	1500	6,35
WP-604	103	103	2000	6,35
WP-605	103	103	600	6,35
WP-606	103	103	850	6,35
WP-607	103	103	900	6,35
WP-608	103	103	3000	6,35
WP-609	103	103	1900	6,35
WP-610	103	103	800	6,35
WP-611	103	103	750	6,35
WP-612	103	103	500	6,35
WP-613	103	103	700	6,35
WP-614	103	103	3200	6,35
WP-615	103	103	550	6,35
WP-616	103	103	1100	6,35
WP-617	103	103	1200	6,35
WP-618	103	103	2600	6,35
WP-619	103	103	2200	6,35
WP-620	103	103	2500	6,35
WP-621	103	103	1400	6,35
WP-622	103	103	180	6,35
WP-623	103	103	1220	6,35
WP-624	103	103	590	6,35
WP-625	103	103	720	6,35
WP-626	103	103	3100	6,35
WP-627	103	103	3400	6,35
WP-628	103	103	3600	6,35
WP-629	103	103	1600	6,35
WP-630	103	103	4000	6,35
WP-631	103	103	450	6,35
WP-632	103	103	3500	6,35
WP-633	103	103	950	6,35
WP-634	103	103	300	6,35
WP-635	119	119	1000	6,35
WP-636	119	119	1500	6,35
WP-637	119	119	2000	6,35
WP-638	119	119	2500	6,35
WP-639	103	103	400	6,35
WP-640	103	103	2700	6,35
WP-641	103	103	1800	6,35
WP-642	103	103	3700	6,35
WP-643	103	103	250	6,35
WP-644	103	103	430	6,35
WP-645	103	103	1450	6,35
WP-646	103	103	2050	6,35
WP-650	161	161	800	6,35
WP-651	161	161	1000	6,35
WP-652	161	161	1200	6,35
WP-653	161	161	1250	6,35
WP-654	161	161	1300	6,35
WP-655	161	161	1350	6,35
WP-656	161	161	1550	6,35
WP-657	161	161	1600	6,35
WP-658	161	161	650	6,35
WP-659	161	161	450	6,35
WP-700	104	106	2400	4,75
WP-701	104	106	3150	4,75
WP-702	104	106	3950	4,75
WP-703	104	116	450	4,75
WP-704	104	116	1500	4,75
WP-705	105	105	100	4,75
WP-706	105	105	2450	4,75
WP-707	105	105	2650	4,75

INDEKS
INDEX
ИНДЕКС

ZŁĄCZKA
FITTING
НАКОНЕЧНИК

ZŁĄCZKA
FITTING
НАКОНЕЧНИК

DŁUGOŚĆ W MM
LENGHT IN MM
ДЛИНА В ММ

ŚREDNICA RURY
DIAMETER
ДИАМЕТР ТРУБЫ

INDEKS
INDEX
ИНДЕКС

ZŁĄCZKA
FITTING
НАКОНЕЧНИК

ZŁĄCZKA
FITTING
НАКОНЕЧНИК

DŁUGOŚĆ W MM
LENGHT IN MM
ДЛИНА В ММ

ŚREDNICA RURY
DIAMETER
ДИАМЕТР ТРУБЫ

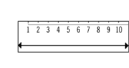
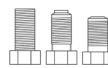
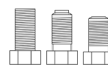
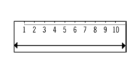
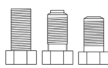
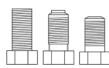

INDEKS INDEX ИНДЕКС	ZŁĄCZKA FITTING НАКОНЕЧНИК	ZŁĄCZKA FITTING НАКОНЕЧНИК	DŁUGOŚĆ W MM LENGHT IN MM ДЛИНА В ММ	ŚREDNICA RURY DIAMETER ДИАМЕТР ТРУБЫ
WP-708	105	105	2850	4,75
WP-709	105	105	3150	4,75
WP-710	105	105	3450	4,75
WP-711	105	105	3550	4,75
WP-712	105	105	4050	4,75
WP-713	105	105	4600	4,75
WP-714	105	105	5100	4,75
WP-715	105	106	1800	4,75
WP-716	105	106	2150	4,75
WP-717	105	106	2350	4,75
WP-718	105	106	3550	4,75
WP-719	105	106	3650	4,75
WP-720	105	107	650	4,75
WP-721	105	107	700	4,75
WP-722	105	107	3200	4,75
WP-723	104	104	300	4,75
WP-724	105	105	260	4,75
WP-725	105	105	290	4,75
WP-726	105	110	150	4,75
WP-727	105	110	650	4,75
WP-728	105	110	1500	4,75
WP-729	105	110	3150	4,75
WP-730	105	112	600	4,75
WP-731	105	112	700	4,75
WP-732	105	112	1150	4,75
WP-733	105	112	1350	4,75
WP-734	105	112	2250	4,75
WP-735	105	116	250	4,75
WP-736	105	116	500	4,75
WP-737	105	116	550	4,75
WP-738	105	116	700	4,75
WP-739	105	116	850	4,75
WP-740	105	116	1000	4,75
WP-741	105	116	1050	4,75
WP-742	105	116	1200	4,75
WP-743	105	116	1250	4,75
WP-744	105	116	1950	4,75
WP-745	105	116	2050	4,75
WP-746	105	116	2950	4,75
WP-747	105	116	3000	4,75
WP-748	105	116	3100	4,75
WP-749	105	116	3400	4,75
WP-750	105	116	3450	4,75
WP-751	105	116	3600	4,75
WP-752	105	116	3650	4,75
WP-753	105	116	4250	4,75
WP-754	105	116	4400	4,75
WP-755	105	116	4450	4,75
WP-756	105	116	4550	4,75
WP-757	105	116	4750	4,75
WP-758	106	106	400	4,75
WP-759	106	106	550	4,75
WP-760	106	106	750	4,75
WP-761	106	106	1800	4,75
WP-762	106	106	2100	4,75
WP-763	106	106	2250	4,75
WP-764	109	109	250	4,75
WP-765	109	109	2050	4,75
WP-766	109	109	2550	4,75
WP-767	109	109	2650	4,75
WP-768	109	109	3400	4,75
WP-769	109	109	3550	4,75
WP-770	109	110	1250	4,75
WP-771	109	110	2050	4,75
WP-772	109	110	2450	4,75
WP-773	109	110	2600	4,75
WP-774	109	110	2950	4,75
WP-775	109	110	3050	4,75
WP-776	109	110	3250	4,75
WP-777	109	114	2950	4,75
WP-778	109	114	3050	4,75
WP-779	109	114	3150	4,75
WP-780	110	110	200	4,75
WP-781	110	110	2250	4,75
WP-782	110	114	350	4,75
WP-783	110	114	950	4,75
WP-784	110	114	2700	4,75
WP-785	110	114	2950	4,75
WP-786	104	104	2600	4,75
WP-787	112	112	700	4,75
WP-788	112	112	2350	4,75
WP-789	112	112	2800	4,75
WP-790	112	112	3200	4,75

INDEKS INDEX ИНДЕКС	ZŁĄCZKA FITTING НАКОНЕЧНИК	ZŁĄCZKA FITTING НАКОНЕЧНИК	DŁUGOŚĆ W MM LENGHT IN MM ДЛИНА В ММ	ŚREDNICA RURY DIAMETER ДИАМЕТР ТРУБЫ
WP-791	112	112	3250	4,75
WP-792	112	112	3400	4,75
WP-793	113	113	400	4,75
WP-794	113	113	500	4,75
WP-795	113	113	900	4,75
WP-796	113	113	1150	4,75
WP-797	113	113	1400	4,75
WP-798	113	113	1500	4,75
WP-799	113	113	2350	4,75
WP-800	113	113	2800	4,75
WP-801	113	113	4200	4,75
WP-802	113	113	4300	4,75
WP-803	115	115	2600	4,75
WP-804	115	115	2650	4,75
WP-805	115	115	2950	4,75
WP-806	105	105	320	4,75
WP-807	105	105	360	4,75
WP-808	105	105	440	4,75
WP-809	116	116	1150	4,75
WP-810	116	116	1250	4,75
WP-811	104	105	150	4,75
WP-812	116	116	1750	4,75
WP-813	116	116	1950	4,75
WP-814	116	116	2050	4,75
WP-815	116	116	2150	4,75
WP-816	116	116	2250	4,75
WP-817	116	116	2350	4,75
WP-818	116	116	2550	4,75
WP-819	116	116	2700	4,75
WP-820	116	116	2950	4,75
WP-821	116	116	3000	4,75
WP-822	116	116	3050	4,75
WP-823	116	116	3250	4,75
WP-824	116	116	3350	4,75
WP-825	116	116	3450	4,75
WP-826	116	116	3950	4,75
WP-827	116	116	4300	4,75
WP-828	116	116	4400	4,75
WP-829	104	110X	3550	4,75
WP-830	104	110X	4000	4,75
WP-831	104X	104X	550	4,75
WP-832	105	104X	850	4,75
WP-833	105	104X	950	4,75
WP-834	105	104X	2500	4,75
WP-835	105	105X	800	4,75
WP-836	105	105X	850	4,75
WP-837	105	105X	1000	4,75
WP-838	105	105X	1050	4,75
WP-839	105	105X	1200	4,75
WP-840	105	105X	1350	4,75
WP-841	105	105X	1600	4,75
WP-842	105	110X	1400	4,75
WP-843	105	110X	2250	4,75
WP-844	105	110X	3300	4,75
WP-845	105	110X	3900	4,75
WP-846	105	116X	300	4,75
WP-847	105	116X	550	4,75
WP-848	105	116X	3200	4,75
WP-849	116	116X	200	4,75
WP-850	116	116X	400	4,75
WP-851	116	116X	450	4,75
WP-852	116	116X	500	4,75
WP-853	116	116X	550	4,75
WP-854	116	116X	1000	4,75
WP-855	116	116X	1100	4,75
WP-856	116	116X	1300	4,75
WP-857	116	116X	1650	4,75
WP-858	116	116X	1850	4,75
WP-859	116	116X	2250	4,75
WP-860	116	116X	2500	4,75
WP-861	116	116X	2600	4,75
WP-862	116	116X	3400	4,75
WP-863	116	116X	3700	4,75
WP-864	116	116X	4000	4,75
WP-865	116	116X	4200	4,75
WP-866	116	116X	4400	4,75
WP-867	116	116X	4450	4,75
WP-868	116	116X	4500	4,75
WP-869	104	104	3500	4,75
WP-870	105	116	1900	4,75
WP-871	104	104	350	4,75
WP-872	104	104	1100	4,75
WP-873	104	104	1150	4,75

INDEKS
INDEX
ИНДЕКС

ZŁĄCZKA
FITTING
НАКОНЕЧНИК

ZŁĄCZKA
FITTING
НАКОНЕЧНИК

DŁUGOŚĆ W MM
LENGHT IN MM
ДЛИНА В ММ

ŚREDNICA RURY
DIAMETER
ДИАМЕТР ТРУБЫ

INDEKS
INDEX
ИНДЕКС

ZŁĄCZKA
FITTING
НАКОНЕЧНИК

ZŁĄCZKA
FITTING
НАКОНЕЧНИК

DŁUGOŚĆ W MM
LENGHT IN MM
ДЛИНА В ММ

ŚREDNICA RURY
DIAMETER
ДИАМЕТР ТРУБЫ



WP-001

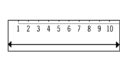
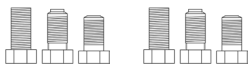

WP-001

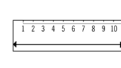
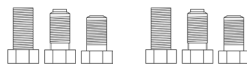

INDEKS	ZŁĄCZKA	ZŁĄCZKA	DŁUGOŚĆ W MM	ŚREDNICA RURY
INDEX	FITTING	FITTING	LENGHT IN MM	DIAMETER
ИНДЕКС	НАКОНЕЧНИК	НАКОНЕЧНИК	ДЛИНА В ММ	ДИАМЕТР ТРУБЫ
WP-874	104	104	4550	4,75
WP-875	104	105	3650	4,75
WP-876	104	105	3750	4,75
WP-877	104	105	3950	4,75
WP-878	104	105	4150	4,75
WP-879	104	106	500	4,75
WP-880	104	106	550	4,75
WP-881	104	106	1050	4,75
WP-882	104	106	2450	4,75
WP-883	104	106	3750	4,75
WP-884	104	106	4250	4,75
WP-885	104	107	450	4,75
WP-886	104	107	500	4,75
WP-887	104	107	950	4,75
WP-888	104	108	1350	4,75
WP-889	104	108	3550	4,75
WP-890	105	105	3350	4,75
WP-891	105	105	3650	4,75
WP-892	105	105	3950	4,75
WP-893	105	105	4150	4,75
WP-894	105	105	4550	4,75
WP-895	105	105	4850	4,75
WP-896	105	106	3350	4,75
WP-897	105	108	300	4,75
WP-898	105	108	900	4,75
WP-899	105	108	1150	4,75
WP-900	105	108	1300	4,75
WP-901	105	108	1900	4,75
WP-902	105	108	2900	4,75
WP-903	105	113	1100	4,75
WP-904	105	116	200	4,75
WP-905	105	116	450	4,75
WP-906	105	116	600	4,75
WP-907	105	116	1400	4,75
WP-908	105	116	1500	4,75
WP-909	105	116	2000	4,75
WP-910	105	116	2200	4,75
WP-911	105	116	2400	4,75
WP-912	105	116	3900	4,75
WP-913	105	116	4650	4,75
WP-914	106	107	200	4,75
WP-915	106	116	2800	4,75
WP-916	113	113	3200	4,75
WP-917	116	116	1300	4,75
WP-918	116	116	3750	4,75
WP-919	116	116	4450	4,75
WP-920	116	116	4750	4,75
WP-921	104	110X	3300	4,75
WP-922	105	105X	600	4,75
WP-923	105	105X	1300	4,75
WP-924	105	110X	3950	4,75
WP-925	116	116X	150	4,75
WP-926	116	116X	1050	4,75
WP-927	105	105	460	4,75
WP-928	105	105	510	4,75
WP-929	105	105	560	4,75
WP-930	105	105	620	4,75
WP-931	105	105	760	4,75
WP-932	105	105	720	4,75
WP-933	105	105	860	4,75
WP-934	105	105	1010	4,75
WP-935	105	105	1060	4,75
WP-936	105	105	1190	4,75
WP-937	105	105	1340	4,75
WP-938	105	105	1480	4,75
WP-939	105	105	280	4,75
WP-940	105	105	370	4,75
WP-941	105	105	410	4,75
WP-942	105	105	430	4,75
WP-943	105	105	490	4,75
WP-944	105	105	560	4,75
WP-945	105	105	640	4,75
WP-946	105	105	1270	4,75
WP-947	105	105	1330	4,75
WP-948	105	105	1390	4,75
WP-949	105	105	1490	4,75
WP-950	105	105	2170	4,75
WP-951	116	116	115	4,75
WP-952	116	116	130	4,75
WP-953	116	116	210	4,75
WP-954	116	116	230	4,75
WP-955	116	116	270	4,75
WP-956	116	116	380	4,75

INDEKS	ZŁĄCZKA	ZŁĄCZKA	DŁUGOŚĆ W MM	ŚREDNICA RURY
INDEX	FITTING	FITTING	LENGHT IN MM	DIAMETER
ИНДЕКС	НАКОНЕЧНИК	НАКОНЕЧНИК	ДЛИНА В ММ	ДИАМЕТР ТРУБЫ
WP-957	116	116	430	4,75
WP-958	116	116	480	4,75
WP-959	116	116	780	4,75
WP-960	116	116	840	4,75
WP-961	116	116	1010	4,75
WP-962	116	116	1310	4,75
WP-963	116	116	3330	4,75
WP-964	116	116	3660	4,75
WP-965	116	116	3930	4,75
WP-966	105	106	140	4,75
WP-967	105	106	180	4,75
WP-968	105	106	240	4,75
WP-969	105	106	290	4,75
WP-970	105	106	380	4,75
WP-971	105	106	510	4,75
WP-972	105	106	660	4,75
WP-973	112	112	260	4,75
WP-974	112	112	1120	4,75
WP-975	109	110	320	4,75
WP-976	104	105	570	4,75
WP-977	105	116	3480	4,75
WP-978	105	116	4380	4,75
WP-979	104	104	150	4,75
WP-980	104	104	4700	4,75
WP-981	104	105	420	4,75
WP-982	104	105	560	4,75
WP-983	104	105	920	4,75
WP-984	105	105	90	4,75
WP-985	105	105	3020	4,75
WP-986	109	109	2500	4,75
WP-987	116	118	500	4,75
WP-988	116	118	200	4,75
WP-989	105	105	820	4,75
WP-990	105	105	520	4,75
WP-991	112	112	610	4,75
WP-992	112	112	2980	4,75
WP-993	112	112	1070	4,75
WP-994	116	116	580	4,75
WP-995	105A	105A	100	4,75
WP-996	105A	105A	115	4,75
WP-997	105A	105A	140	4,75
WP-998	106	105A	140	4,75
WP-999	110	105A	140	4,75
WP-1000	109	110	140	4,75
WP-1001	105A	105A	150	4,75
WP-1002	116	105D	150	4,75
WP-1003	105D	105D	160	4,75
WP-1004	113	113	160	4,75
WP-1005	116	116	165	4,75
WP-1006	105A	105A	170	4,75
WP-1007	105A	105A	180	4,75
WP-1008	106	105A	180	4,75
WP-1009	105D	105D	180	4,75
WP-1010	116	116	180	4,75
WP-1011	109	110	190	4,75
WP-1012	110	110	195	4,75
WP-1013	105A	105A	200	4,75
WP-1014	105A	105A	210	4,75
WP-1015	112	112	220	4,75
WP-1016	104	105A	225	4,75
WP-1017	116	105D	230	4,75
WP-1018	109	109	230	4,75
WP-1019	105A	105A	240	4,75
WP-1020	106	105A	240	4,75
WP-1021	111	111	240	4,75
WP-1022	106	105A	250	4,75
WP-1023	110	105A	250	4,75
WP-1024	116	116	255	4,75
WP-1025	116	116X	255	4,75
WP-1026	105A	105A	260	4,75
WP-1027	108	105A	260	4,75
WP-1028	105D	105D	260	4,75
WP-1029	116	105D	260	4,75
WP-1030	109	110	260	4,75
WP-1031	111	115	270	4,75
WP-1032	105D	105D	280	4,75
WP-1033	116	105D	280	4,75
WP-1034	116	116	280	4,75
WP-1035	105A	105A	290	4,75
WP-1036	106	105A	290	4,75
WP-1037	105D	105D	290	4,75
WP-1038	109	111	290	4,75
WP-1039	104	105A	295	4,75

INDEKS
INDEX
ИНДЕКС

ZŁĄCZKA
FITTING
НАКОНЕЧНИК

ZŁĄCZKA
FITTING
НАКОНЕЧНИК

DŁUGOŚĆ W MM
LENGHT IN MM
ДЛИНА В MM

ŚREDNICA RURY
DIAMETER
ДИАМЕТР ТРУБЫ

INDEKS
INDEX
ИНДЕКС

ZŁĄCZKA
FITTING
НАКОНЕЧНИК

ZŁĄCZKA
FITTING
НАКОНЕЧНИК

DŁUGOŚĆ W MM
LENGHT IN MM
ДЛИНА В MM

ŚREDNICA RURY
DIAMETER
ДИАМЕТР ТРУБЫ

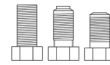
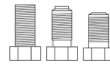
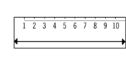
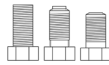
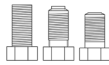

INDEKS INDEX ИНДЕКС	ZŁĄCZKA FITTING НАКОНЕЧНИК	ZŁĄCZKA FITTING НАКОНЕЧНИК	DŁUGOŚĆ W MM LENGHT IN MM ДЛИНА В MM	ŚREDNICA RURY DIAMETER ДИАМЕТР ТРУБЫ	INDEKS INDEX ИНДЕКС	ZŁĄCZKA FITTING НАКОНЕЧНИК	ZŁĄCZKA FITTING НАКОНЕЧНИК	DŁUGOŚĆ W MM LENGHT IN MM ДЛИНА В MM	ŚREDNICA RURY DIAMETER ДИАМЕТР ТРУБЫ
WP-1040	109	110	295	4,75	WP-1123	111	115	525	4,75
WP-1041	105A	105A	300	4,75	WP-1124	104	105D	530	4,75
WP-1042	108	105A	300	4,75	WP-1125	105D	116X	530	4,75
WP-1043	105D	116X	300	4,75	WP-1126	116	116	530	4,75
WP-1044	106	105A	305	4,75	WP-1127	105A	105A	540	4,75
WP-1045	105D	105D	310	4,75	WP-1128	104	104	540	4,75
WP-1046	116	116	310	4,75	WP-1129	105D	105D	540	4,75
WP-1047	105D	105D	315	4,75	WP-1130	109	110	540	4,75
WP-1048	105A	105A	320	4,75	WP-1131	113	113	540	4,75
WP-1049	116	105D	320	4,75	WP-1132	116	116	540	4,75
WP-1050	113	113	320	4,75	WP-1133	104	105A	550	4,75
WP-1051	106	105A	325	4,75	WP-1134	105D	105D	550	4,75
WP-1052	105A	105A	330	4,75	WP-1135	105A	105A	560	4,75
WP-1053	116	105A	330	4,75	WP-1136	105D	105D	560	4,75
WP-1054	116	105D	330	4,75	WP-1137	105A	105A	570	4,75
WP-1055	112	112	330	4,75	WP-1138	112	105A	570	4,75
WP-1056	115	115	330	4,75	WP-1139	104	105A	570	4,75
WP-1057	105D	105D	340	4,75	WP-1140	104X	104X	570	4,75
WP-1058	111	115	340	4,75	WP-1141	105D	105D	575	4,75
WP-1059	116	116	340	4,75	WP-1142	104	105A	580	4,75
WP-1060	105A	105A	350	4,75	WP-1143	104	104	580	4,75
WP-1061	106	105A	350	4,75	WP-1144	104	106	580	4,75
WP-1062	104	105A	350	4,75	WP-1145	109	110	580	4,75
WP-1063	105A	105A	360	4,75	WP-1146	105A	105A	590	4,75
WP-1064	108	105A	360	4,75	WP-1147	105A	104X	600	4,75
WP-1065	111	115	360	4,75	WP-1148	105D	105D	600	4,75
WP-1066	116	105D	365	4,75	WP-1149	105A	105A	610	4,75
WP-1067	105D	105D	370	4,75	WP-1150	105D	105D	610	4,75
WP-1068	116	105D	370	4,75	WP-1151	105A	105A	620	4,75
WP-1069	112	112	375	4,75	WP-1152	106	105A	620	4,75
WP-1070	115	115	375	4,75	WP-1153	107	105A	620	4,75
WP-1071	105A	105A	380	4,75	WP-1154	105D	105D	620	4,75
WP-1072	106	105A	380	4,75	WP-1155	104	105A	630	4,75
WP-1073	105A	105A	390	4,75	WP-1156	104	105D	630	4,75
WP-1074	105D	105D	390	4,75	WP-1157	116	116	630	4,75
WP-1075	106	106	390	4,75	WP-1158	106	105A	640	4,75
WP-1076	109	109	390	4,75	WP-1159	105D	105D	640	4,75
WP-1077	105A	105A	400	4,75	WP-1160	109	110	640	4,75
WP-1078	106	105A	400	4,75	WP-1161	112	112	640	4,75
WP-1079	104	105A	400	4,75	WP-1162	116	116	640	4,75
WP-1080	116	105D	400	4,75	WP-1163	105A	105A	650	4,75
WP-1081	105A	105A	410	4,75	WP-1164	106	105A	660	4,75
WP-1082	104	116	410	4,75	WP-1165	116	105D	660	4,75
WP-1083	105D	105D	410	4,75	WP-1166	116	116	660	4,75
WP-1084	109	114	410	4,75	WP-1167	105A	105A	670	4,75
WP-1085	105A	105A	420	4,75	WP-1168	104	105A	670	4,75
WP-1086	105D	105D	420	4,75	WP-1169	105D	105X	670	4,75
WP-1087	104	105D	430	4,75	WP-1170	107	105A	680	4,75
WP-1088	105D	105D	430	4,75	WP-1171	105D	105D	680	4,75
WP-1089	109	109	430	4,75	WP-1172	116	116	680	4,75
WP-1090	112	112	430	4,75	WP-1173	113	113	685	4,75
WP-1091	105A	105A	440	4,75	WP-1174	106	105A	690	4,75
WP-1092	108	105A	440	4,75	WP-1175	112	105A	690	4,75
WP-1093	109	109	440	4,75	WP-1176	105D	105X	690	4,75
WP-1094	106	105A	450	4,75	WP-1177	111	115	690	4,75
WP-1095	105D	105D	450	4,75	WP-1178	105A	105A	700	4,75
WP-1096	105A	105A	460	4,75	WP-1179	104	105A	700	4,75
WP-1097	108	105A	460	4,75	WP-1180	104	105D	700	4,75
WP-1098	105D	105D	460	4,75	WP-1181	105D	105D	710	4,75
WP-1099	112	112	460	4,75	WP-1182	109	110	710	4,75
WP-1100	113	113	460	4,75	WP-1183	105A	105A	720	4,75
WP-1101	116	116	460	4,75	WP-1184	106	105A	725	4,75
WP-1102	116	105A	470	4,75	WP-1185	116	116	735	4,75
WP-1103	105A	105A	480	4,75	WP-1186	104	106	740	4,75
WP-1104	105D	105X	480	4,75	WP-1187	109	109	740	4,75
WP-1105	116	105D	480	4,75	WP-1188	112	112	740	4,75
WP-1106	112	112	480	4,75	WP-1189	110	114	740	4,75
WP-1107	111	115	480	4,75	WP-1190	115	115	740	4,75
WP-1108	104	105A	485	4,75	WP-1191	104	105A	750	4,75
WP-1109	104	105D	485	4,75	WP-1192	104	105D	750	4,75
WP-1110	105D	105D	490	4,75	WP-1193	105D	105D	750	4,75
WP-1111	115	115	490	4,75	WP-1194	116	105D	750	4,75
WP-1112	105A	105A	500	4,75	WP-1195	112	112	755	4,75
WP-1113	104	105A	500	4,75	WP-1196	105A	105A	760	4,75
WP-1114	105D	105X	500	4,75	WP-1197	107	105A	760	4,75
WP-1115	105A	105A	510	4,75	WP-1198	111	115	760	4,75
WP-1116	106	105A	510	4,75	WP-1199	109	109	765	4,75
WP-1117	107	105A	510	4,75	WP-1200	105A	105A	780	4,75
WP-1118	116	105D	510	4,75	WP-1201	106	105A	780	4,75
WP-1119	105A	105A	520	4,75	WP-1202	105D	105D	780	4,75
WP-1120	105D	105D	520	4,75	WP-1203	105D	105X	780	4,75
WP-1121	112	112	520	4,75	WP-1204	109	110	790	4,75
WP-1122	116	116	520	4,75	WP-1205	105A	105A	800	4,75

INDEKS
INDEX
ИНДЕКС

ZŁĄCZKA
FITTING
НАКОНЕЧНИК

ZŁĄCZKA
FITTING
НАКОНЕЧНИК

DLUGOŚĆ W MM
LENGHT IN MM
ДЛИНА В ММ

ŚREDNICA RURY
DIAMETER
ДИАМЕТР ТРУБЫ

INDEKS
INDEX
ИНДЕКС

ZŁĄCZKA
FITTING
НАКОНЕЧНИК

ZŁĄCZKA
FITTING
НАКОНЕЧНИК

DLUGOŚĆ W MM
LENGHT IN MM
ДЛИНА В ММ

ŚREDNICA RURY
DIAMETER
ДИАМЕТР ТРУБЫ

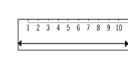
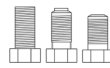
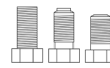
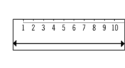
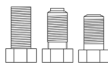
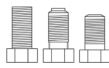

INDEKS INDEX ИНДЕКС	ZŁĄCZKA FITTING НАКОНЕЧНИК	ZŁĄCZKA FITTING НАКОНЕЧНИК	DLUGOŚĆ W MM LENGHT IN MM ДЛИНА В ММ	ŚREDNICA RURY DIAMETER ДИАМЕТР ТРУБЫ	INDEKS INDEX ИНДЕКС	ZŁĄCZKA FITTING НАКОНЕЧНИК	ZŁĄCZKA FITTING НАКОНЕЧНИК	DLUGOŚĆ W MM LENGHT IN MM ДЛИНА В ММ	ŚREDNICA RURY DIAMETER ДИАМЕТР ТРУБЫ
WP-1206	104X	104X	800	4,75	WP-1289	105D	105D	1100	4,75
WP-1207	104	105D	810	4,75	WP-1290	116	105D	1100	4,75
WP-1208	116	116	810	4,75	WP-1291	105A	105A	1110	4,75
WP-1209	105A	105A	820	4,75	WP-1292	113	113	1110	4,75
WP-1210	104X	104X	820	4,75	WP-1293	104	105A	1120	4,75
WP-1211	105D	105D	820	4,75	WP-1294	116	116	1120	4,75
WP-1212	116	105D	820	4,75	WP-1295	112	105A	1140	4,75
WP-1213	106	105A	830	4,75	WP-1296	105D	105D	1140	4,75
WP-1214	104	105A	830	4,75	WP-1297	116	105D	1140	4,75
WP-1215	105A	105X	840	4,75	WP-1298	105A	105A	1150	4,75
WP-1216	109	110	840	4,75	WP-1299	106	105A	1150	4,75
WP-1217	113	113	840	4,75	WP-1300	104	105D	1150	4,75
WP-1218	110	114	845	4,75	WP-1301	116	116	1160	4,75
WP-1219	106	105A	850	4,75	WP-1302	108	105A	1170	4,75
WP-1220	104	105D	850	4,75	WP-1303	113	113	1170	4,75
WP-1221	105D	105D	850	4,75	WP-1304	105D	105D	1180	4,75
WP-1222	105D	105X	850	4,75	WP-1305	105A	105A	1190	4,75
WP-1223	105A	105A	860	4,75	WP-1306	104	105A	1190	4,75
WP-1224	104	106	860	4,75	WP-1307	105D	105X	1200	4,75
WP-1225	116	105D	860	4,75	WP-1308	116	105D	1200	4,75
WP-1226	112	112	865	4,75	WP-1309	105D	105D	1210	4,75
WP-1227	116	116	870	4,75	WP-1310	105A	105A	1220	4,75
WP-1228	105A	105A	880	4,75	WP-1311	116	105A	1220	4,75
WP-1229	116	105D	880	4,75	WP-1312	109	110	1225	4,75
WP-1230	109	110	890	4,75	WP-1313	112	112	1225	4,75
WP-1231	115	115	890	4,75	WP-1314	106	105A	1240	4,75
WP-1232	105A	105A	900	4,75	WP-1315	105D	105D	1240	4,75
WP-1233	106	105A	900	4,75	WP-1316	105D	105X	1240	4,75
WP-1234	104	105A	900	4,75	WP-1317	116	116	1240	4,75
WP-1235	105D	105D	900	4,75	WP-1318	105A	105A	1250	4,75
WP-1236	105A	105A	920	4,75	WP-1319	104	104X	1250	4,75
WP-1237	105D	105D	920	4,75	WP-1320	105A	104X	1250	4,75
WP-1238	116	105D	920	4,75	WP-1321	116	105D	1260	4,75
WP-1239	109	109	930	4,75	WP-1322	109	110	1260	4,75
WP-1240	115	115	930	4,75	WP-1323	116	116X	1260	4,75
WP-1241	104	106	940	4,75	WP-1324	105D	105D	1270	4,75
WP-1242	110	114	940	4,75	WP-1325	104	106	1280	4,75
WP-1243	116	116	940	4,75	WP-1326	106	105A	1290	4,75
WP-1244	106	105A	950	4,75	WP-1327	105A	105A	1300	4,75
WP-1245	105D	105D	950	4,75	WP-1328	116	105D	1300	4,75
WP-1246	116	105D	950	4,75	WP-1329	112	105A	1320	4,75
WP-1247	105A	105A	960	4,75	WP-1330	105D	105D	1330	4,75
WP-1248	108	105A	960	4,75	WP-1331	105A	105A	1340	4,75
WP-1249	104	105A	960	4,75	WP-1332	104	105A	1340	4,75
WP-1250	116	105D	960	4,75	WP-1333	105D	105X	1340	4,75
WP-1251	116	116	960	4,75	WP-1334	106	105A	1350	4,75
WP-1252	107	105A	970	4,75	WP-1335	105A	104X	1350	4,75
WP-1253	109	110	970	4,75	WP-1336	116	105D	1350	4,75
WP-1254	105A	105A	980	4,75	WP-1337	105A	105A	1370	4,75
WP-1255	104	105A	980	4,75	WP-1338	112	112	1370	4,75
WP-1256	105D	105D	980	4,75	WP-1339	104	106	1375	4,75
WP-1257	113	113	985	4,75	WP-1340	110	114	1375	4,75
WP-1258	106	105A	990	4,75	WP-1341	105A	105A	1385	4,75
WP-1259	105A	105A	1000	4,75	WP-1342	106	105A	1390	4,75
WP-1260	104	105A	1000	4,75	WP-1343	105D	105D	1390	4,75
WP-1261	105A	104X	1000	4,75	WP-1344	105A	105A	1400	4,75
WP-1262	105D	105D	1000	4,75	WP-1345	104	105A	1420	4,75
WP-1263	105D	105X	1000	4,75	WP-1346	104	106	1420	4,75
WP-1264	105A	105A	1010	4,75	WP-1347	116	105D	1420	4,75
WP-1265	108	105A	1020	4,75	WP-1348	105A	105A	1430	4,75
WP-1266	112	105A	1020	4,75	WP-1349	105D	105D	1430	4,75
WP-1267	105D	105X	1020	4,75	WP-1350	116	116	1430	4,75
WP-1268	116	105A	1020	4,75	WP-1351	105A	105A	1440	4,75
WP-1269	112	112	1020	4,75	WP-1352	109	109	1440	4,75
WP-1270	113	113	1020	4,75	WP-1353	112	112	1440	4,75
WP-1271	111	115	1020	4,75	WP-1354	105D	105D	1450	4,75
WP-1272	116	116	1030	4,75	WP-1355	116	105D	1450	4,75
WP-1273	105A	105A	1040	4,75	WP-1356	105A	105A	1460	4,75
WP-1274	104	105D	1040	4,75	WP-1357	105A	105A	1480	4,75
WP-1275	105D	105D	1040	4,75	WP-1358	104	116	1480	4,75
WP-1276	115	115	1040	4,75	WP-1359	105D	105D	1490	4,75
WP-1277	106	105A	1050	4,75	WP-1360	105A	105A	1500	4,75
WP-1278	105A	105A	1060	4,75	WP-1361	106	105A	1500	4,75
WP-1279	105D	105X	1060	4,75	WP-1362	105A	105A	1530	4,75
WP-1280	109	109	1060	4,75	WP-1363	104	105A	1530	4,75
WP-1281	116	105D	1070	4,75	WP-1364	104	106	1530	4,75
WP-1282	116	116	1070	4,75	WP-1365	106	105A	1540	4,75
WP-1283	113	113	1090	4,75	WP-1366	109	109	1540	4,75
WP-1284	111	115	1090	4,75	WP-1367	116	116	1540	4,75
WP-1285	116	116	1090	4,75	WP-1368	105A	105A	1550	4,75
WP-1286	105A	105A	1100	4,75	WP-1369	105D	105D	1550	4,75
WP-1287	106	105A	1100	4,75	WP-1370	105D	105X	1560	4,75
WP-1288	104	105A	1100	4,75	WP-1371	112	112	1570	4,75



WP-1372	113	113	1570	4,75
WP-1373	105A	105A	1580	4,75
WP-1374	116	116	1580	4,75
WP-1375	106	105A	1590	4,75
WP-1376	105A	105A	1600	4,75
WP-1377	104	105A	1600	4,75
WP-1378	116	116	1610	4,75
WP-1379	105A	105A	1630	4,75
WP-1380	105D	105D	1630	4,75
WP-1381	116	116X	1630	4,75
WP-1382	105A	105A	1660	4,75
WP-1383	104	105A	1660	4,75
WP-1384	105D	105D	1660	4,75
WP-1385	112	112	1665	4,75
WP-1386	111	115	1680	4,75
WP-1387	116	116	1680	4,75
WP-1388	106	105A	1690	4,75
WP-1389	112	112	1690	4,75
WP-1390	105A	105A	1700	4,75
WP-1391	105A	104X	1710	4,75
WP-1392	105D	105D	1720	4,75
WP-1393	110	114	1730	4,75
WP-1394	106	105A	1740	4,75
WP-1395	109	110	1740	4,75
WP-1396	116	116	1740	4,75
WP-1397	105A	105A	1760	4,75
WP-1398	104	105A	1780	4,75
WP-1399	105A	105A	1790	4,75
WP-1400	105D	105D	1800	4,75
WP-1401	105A	105A	1815	4,75
WP-1402	105D	105D	1820	4,75
WP-1403	104	105A	1830	4,75
WP-1404	111	115	1840	4,75
WP-1405	106	105A	1850	4,75
WP-1406	105A	105A	1860	4,75
WP-1407	116	105D	1860	4,75
WP-1408	116	116	1870	4,75
WP-1409	104	105D	1890	4,75
WP-1410	105D	105D	1890	4,75
WP-1411	116	116	1890	4,75
WP-1412	105A	105A	1900	4,75
WP-1413	106	105A	1900	4,75
WP-1414	105D	105D	1900	4,75
WP-1415	116	116	1910	4,75
WP-1416	109	109	1930	4,75
WP-1417	104	105A	1940	4,75
WP-1418	105D	105D	1940	4,75
WP-1419	116	105D	1940	4,75
WP-1420	116	116	1940	4,75
WP-1421	105A	105A	1950	4,75
WP-1422	104	105A	1970	4,75
WP-1423	112	105A	1975	4,75
WP-1424	105D	105D	1980	4,75
WP-1425	105A	105A	2010	4,75
WP-1426	105D	105D	2020	4,75
WP-1427	109	109	2020	4,75
WP-1428	116	116	2030	4,75
WP-1429	106	105A	2040	4,75
WP-1430	105A	105A	2050	4,75
WP-1431	116	105D	2050	4,75
WP-1432	105D	105D	2060	4,75
WP-1433	116	116	2060	4,75
WP-1434	104	106	2070	4,75
WP-1435	105A	105A	2080	4,75
WP-1436	104	105A	2080	4,75
WP-1437	106	106	2080	4,75
WP-1438	109	109	2080	4,75
WP-1439	105D	105D	2100	4,75
WP-1440	116	116	5650	4,75
WP-1441	106	105A	2120	4,75
WP-1442	116	105D	2120	4,75
WP-1443	105A	105A	2140	4,75
WP-1444	105D	105D	2150	4,75
WP-1445	104	105A	2160	4,75
WP-1446	104	104	2170	4,75
WP-1447	105D	105D	2170	4,75
WP-1448	105A	105A	2200	4,75
WP-1449	106	105A	2200	4,75
WP-1450	116	116	2230	4,75
WP-1451	116	116X	2230	4,75
WP-1452	106	106	2235	4,75
WP-1453	104	105A	2240	4,75
WP-1454	105A	105A	2250	4,75

WP-1455	105D	105D	2250	4,75
WP-1456	115	115	2260	4,75
WP-1457	105A	105A	2300	4,75
WP-1458	106	105A	2300	4,75
WP-1459	116	116	2310	4,75
WP-1460	105A	105A	2350	4,75
WP-1461	106	105A	2350	4,75
WP-1462	105D	105D	2350	4,75
WP-1463	105A	105A	2400	4,75
WP-1464	105D	105D	2400	4,75
WP-1465	105A	105A	2440	4,75
WP-1466	105D	105D	2450	4,75
WP-1467	116	116X	2480	4,75
WP-1468	105A	105A	2500	4,75
WP-1469	106	105A	2500	4,75
WP-1470	105D	105D	2500	4,75
WP-1471	116	116	2530	4,75
WP-1472	105A	105A	2550	4,75
WP-1473	115	115	2555	4,75
WP-1474	109	110	2570	4,75
WP-1475	116	116X	2570	4,75
WP-1476	105A	105A	2600	4,75
WP-1477	106	105A	2600	4,75
WP-1478	105A	105A	2625	4,75
WP-1479	104	105A	2640	4,75
WP-1480	105D	105D	2650	4,75
WP-1481	116	116	2670	4,75
WP-1482	104	106	2690	4,75
WP-1483	110	114	2690	4,75
WP-1484	105A	105A	2700	4,75
WP-1485	105D	105D	2700	4,75
WP-1486	104	105A	2710	4,75
WP-1487	106	105A	2730	4,75
WP-1488	105A	105A	2750	4,75
WP-1489	104	105A	2760	4,75
WP-1490	109	109	2760	4,75
WP-1491	105A	105A	2800	4,75
WP-1492	106	105A	2800	4,75
WP-1493	105D	105D	2800	4,75
WP-1494	112	112	2820	4,75
WP-1495	105A	105A	2850	4,75
WP-1496	105D	105D	2850	4,75
WP-1497	109	109	2870	4,75
WP-1498	105A	105A	2900	4,75
WP-1499	104	105A	2900	4,75
WP-1500	105D	105D	2900	4,75
WP-1501	109	110	2920	4,75
WP-1502	109	114	2930	4,75
WP-1503	116	116	2930	4,75
WP-1504	105D	105D	2950	4,75
WP-1505	104	105D	2950	4,75
WP-1506	105A	104X	2950	4,75
WP-1507	105D	105D	2950	4,75
WP-1508	116	105D	2950	4,75
WP-1509	109	109	2960	4,75
WP-1510	105A	105A	3000	4,75
WP-1511	106	105A	3000	4,75
WP-1512	105A	110X	3000	4,75
WP-1513	104	105A	3000	4,75
WP-1514	105A	104X	3000	4,75
WP-1515	105D	105D	3000	4,75
WP-1516	116	105D	3000	4,75
WP-1517	104	105A	3040	4,75
WP-1518	105A	105A	3050	4,75
WP-1519	105D	105D	3060	4,75
WP-1520	112	112	3080	4,75
WP-1521	105A	105A	3100	4,75
WP-1522	106	105A	3100	4,75
WP-1523	116	105D	3100	4,75
WP-1524	105D	105D	3130	4,75
WP-1525	104	105A	3140	4,75
WP-1526	105A	105A	3150	4,75
WP-1527	116	116	3160	4,75
WP-1528	106	106	3170	4,75
WP-1529	105A	105A	3200	4,75
WP-1530	106	105A	3200	4,75
WP-1531	107	105A	3200	4,75
WP-1532	105D	105D	3200	4,75
WP-1533	105D	116X	3200	4,75
WP-1534	116	105D	3220	4,75
WP-1535	112	112	3220	4,75
WP-1536	116	116	3220	4,75
WP-1537	105A	105A	3240	4,75

INDEKS
INDEX
ИНДЕКС

ZŁĄCZKA
FITTING
НАКОНЕЧНИК

ZŁĄCZKA
FITTING
НАКОНЕЧНИК

DŁUGOŚĆ W MM
LENGHT IN MM
ДЛИНА В ММ

ŚREDNICA RURY
DIAMETER
ДИАМЕТР ТРУБЫ

INDEKS
INDEX
ИНДЕКС

ZŁĄCZKA
FITTING
НАКОНЕЧНИК

ZŁĄCZKA
FITTING
НАКОНЕЧНИК

DŁUGOŚĆ W MM
LENGHT IN MM
ДЛИНА В ММ

ŚREDNICA RURY
DIAMETER
ДИАМЕТР ТРУБЫ

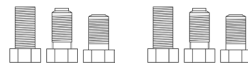
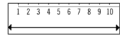
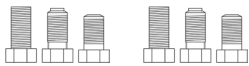



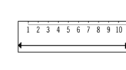
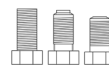
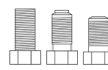
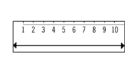
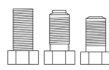
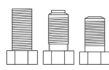

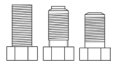
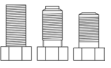

INDEKS INDEX ИНДЕКС	ZŁĄCZKA FITTING НАКОНЕЧНИК	ZŁĄCZKA FITTING НАКОНЕЧНИК	DŁUGOŚĆ W MM LENGHT IN MM ДЛИНА В ММ	ŚREDNICA RURY DIAMETER ДИАМЕТР ТРУБЫ	INDEKS INDEX ИНДЕКС	ZŁĄCZKA FITTING НАКОНЕЧНИК	ZŁĄCZKA FITTING НАКОНЕЧНИК	DŁUGOŚĆ W MM LENGHT IN MM ДЛИНА В ММ	ŚREDNICA RURY DIAMETER ДИАМЕТР ТРУБЫ
WP-1538	109	110	3240	4,75	WP-1621	112	112	1630	4,75
WP-1539	106	105A	3250	4,75	WP-1622	105D	105D	270	4,75
WP-1540	105D	110X	3270	4,75	WP-1623	105D	105D	2600	4,75
WP-1541	104	105A	3280	4,75	WP-1624	104	105	2600	4,75
WP-1542	112	112	3280	4,75	WP-1625	104	105	4400	4,75
WP-1543	105A	105A	3300	4,75	WP-1626	105	105	1820	4,75
WP-1544	106	105A	3300	4,75	WP-1627	105	107	1100	4,75
WP-1545	105D	105D	3300	4,75	WP-1628	106	106	90	4,75
WP-1546	112	112	3370	4,75	WP-1629	114	115	700	4,75
WP-1547	116	116X	3380	4,75	WP-1630	104	104	370	4,75
WP-1548	105A	105A	3400	4,75	WP-1631	105	105	5400	4,75
WP-1549	106	105A	3400	4,75	WP-1632	105	105	5600	4,75
WP-1550	116	105D	3400	4,75	WP-1633	105	105	6000	4,75
WP-1551	104	105A	3430	4,75	WP-1634	104	110X	4020	4,75
WP-1552	105A	105A	3450	4,75	WP-1635	105	116	4420	4,75
WP-1553	116	105D	3450	4,75	WP-1636	105	116	3020	4,75
WP-1554	116	105D	3480	4,75	WP-1637	116	116	3020	4,75
WP-1555	105A	105A	3500	4,75	WP-1638	104	104	650	4,75
WP-1556	105D	105D	3500	4,75	WP-1639	104	106	2300	4,75
WP-1557	104	110X	3510	4,75	WP-1640	105	107	1200	4,75
WP-1558	109	109	3510	4,75	WP-1641	105	107	1450	4,75
WP-1559	105A	105A	3530	4,75	WP-1642	107	107	630	4,75
WP-1560	106	105A	3550	4,75	WP-1643	107	107	1250	4,75
WP-1561	116	105D	3560	4,75	WP-1644	105	105	160	4,75
WP-1562	105A	105A	3600	4,75	WP-1645	104A	105	1200	4,75
WP-1563	104	105D	3600	4,75	WP-1646	104A	105	1450	4,75
WP-1564	105D	105D	3600	4,75	WP-1647	104A	104A	630	4,75
WP-1565	116	105D	3600	4,75	WP-1648	104A	104A	1250	4,75
WP-1566	106	105A	3630	4,75	WP-1649	114	114	600	4,75
WP-1567	116	105D	3650	4,75	WP-1650	104	116	1400	4,75
WP-1568	116	116X	3660	4,75	WP-1651	104	116	4050	4,75
WP-1569	106	105A	3680	4,75	WP-1652	115	115	420	4,75
WP-1570	104	105D	3690	4,75	WP-1653	104	104	400	4,75
WP-1571	105A	105A	3700	4,75	WP-1654	105	112	250	4,75
WP-1572	105D	105D	3700	4,75	WP-1655	104	105	90	4,75
WP-1573	105A	105A	3750	4,75	WP-1656	105	105	190	4,75
WP-1574	116	105D	3760	4,75	WP-1657	105	106	420	4,75
WP-1575	112	105A	3770	4,75	WP-1658	105	106	440	4,75
WP-1576	116	116	3770	4,75	WP-1659	106	106	500	4,75
WP-1577	105A	105A	3820	4,75	WP-1660	104	104	800	4,75
WP-1578	104	105D	3820	4,75	WP-1661	104	104	5000	4,75
WP-1579	116	116	3870	4,75	WP-1662	104A	105	900	4,75
WP-1580	105A	105A	3900	4,75	WP-1663	112	112	320	4,75
WP-1581	105D	110X	3900	4,75	WP-1664	112	112	380	4,75
WP-1582	106	105A	3950	4,75	WP-1665	112	112	2200	4,75
WP-1583	105A	105A	3960	4,75	WP-1666	112	112	1350	4,75
WP-1584	116	116X	3970	4,75	WP-1667	104	105	2150	4,75
WP-1585	105A	105A	4000	4,75	WP-1668	104	105	3400	4,75
WP-1586	104	105A	4000	4,75	WP-1669	104	108	3200	4,75
WP-1587	116	116	4030	4,75	WP-1670	104	110X	600	4,75
WP-1588	105A	105A	4050	4,75	WP-1671	105	106	1650	4,75
WP-1589	105D	105D	4050	4,75	WP-1672	105	106	2450	4,75
WP-1590	116	116	4080	4,75	WP-1673	105	106	2700	4,75
WP-1591	105A	105A	4100	4,75	WP-1674	105	106	2950	4,75
WP-1592	105A	105A	4200	4,75	WP-1675	105	108	3500	4,75
WP-1593	105D	105D	4200	4,75	WP-1676	105	116	2250	4,75
WP-1594	104	105A	4250	4,75	WP-1677	105	116	2800	4,75
WP-1595	116	105D	4250	4,75	WP-1678	105	110X	850	4,75
WP-1596	105A	105A	4300	4,75	WP-1679	105	110X	1000	4,75
WP-1597	104	105D	4300	4,75	WP-1680	105	110X	1050	4,75
WP-1598	105D	105D	4300	4,75	WP-1681	105	110X	1150	4,75
WP-1599	116	116X	4370	4,75	WP-1682	105	110X	1650	4,75
WP-1600	116	105D	4380	4,75	WP-1683	105	110X	1750	4,75
WP-1601	104	105A	4400	4,75	WP-1684	105	110X	2150	4,75
WP-1602	105A	105A	4410	4,75	WP-1685	105	110X	2750	4,75
WP-1603	116	105D	4410	4,75	WP-1686	105	110X	2800	4,75
WP-1604	104	105D	4420	4,75	WP-1687	105	110X	3250	4,75
WP-1605	116	116X	4430	4,75	WP-1688	105	116X	3300	4,75
WP-1606	105D	105D	4500	4,75	WP-1689	105	116X	4500	4,75
WP-1607	116	105D	4550	4,75	WP-1690	106	106	700	4,75
WP-1608	116	105D	4570	4,75	WP-1691	106	106	900	4,75
WP-1609	104	105A	4700	4,75	WP-1692	108	108	2150	4,75
WP-1610	104	105D	4750	4,75	WP-1693	108	116	2050	4,75
WP-1611	116	105D	4750	4,75	WP-1694	108	116	2850	4,75
WP-1612	105A	105A	4800	4,75	WP-1695	108	116	3250	4,75
WP-1613	105D	105D	4800	4,75	WP-1696	105	104X	300	4,75
WP-1614	105A	105A	4880	4,75	WP-1697	105	104X	1050	4,75
WP-1615	104	105A	4900	4,75	WP-1698	105	104X	1750	4,75
WP-1616	104	105A	4970	4,75	WP-1699	105	104X	3400	4,75
WP-1617	105A	105A	5070	4,75	WP-1700	104X	110X	1150	4,75
WP-1618	104	105A	5340	4,75	WP-1701	104X	110X	1200	4,75
WP-1619	105	107	900	4,75	WP-1702	110X	110X	2150	4,75
WP-1620	112	112	1530	4,75	WP-1703	110X	110X	2250	4,75

INDEKS
INDEX
ИНДЕКС**ZŁĄCZKA**
FITTING
НАКОНЕЧНИК**ZŁĄCZKA**
FITTING
НАКОНЕЧНИК**DŁUGOŚĆ W MM**
LENGHT IN MM
ДЛИНА В ММ**ŚREDNICA RURY**
DIAMETER
ДИАМЕТР ТРУБЫ**INDEKS**
INDEX
ИНДЕКС**ZŁĄCZKA**
FITTING
НАКОНЕЧНИК**ZŁĄCZKA**
FITTING
НАКОНЕЧНИК**DŁUGOŚĆ W MM**
LENGHT IN MM
ДЛИНА В ММ**ŚREDNICA RURY**
DIAMETER
ДИАМЕТР ТРУБЫ

WP-1704	105	110X	1350	4,75
WP-1705	105	110X	2300	4,75
WP-1706	105	110X	3600	4,75
WP-1707	105	110X	4100	4,75
WP-1708	104	105	2400	4,75
WP-1709	106	106	2950	4,75
WP-1710	116	116	4600	4,75
WP-1711	105	105	100	4,75
WP-1712	105	105	580	4,75
WP-1713	105	105	660	4,75
WP-1714	105	105	780	4,75
WP-1715	105	105	880	4,75
WP-1716	105	105	1560	4,75
WP-1717	105	105	1660	4,75
WP-1718	105	105	4220	4,75
WP-1719	105	105	4320	4,75
WP-1720	105	105	4420	4,75
WP-1721	112	112	170	4,75
WP-1722	112	112	820	4,75
WP-1723	104	104	2650	4,75
WP-1724	104	104	3600	4,75
WP-1725	104	105	2550	4,75
WP-1726	104	105	3800	4,75
WP-1727	104	106	650	4,75
WP-1728	105	107	2950	4,75
WP-1729	105	108	2500	4,75
WP-1730	105	108	2950	4,75
WP-1731	105	116	1600	4,75
WP-1732	105	116	2500	4,75
WP-1733	105	116	3350	4,75
WP-1734	106	106	1900	4,75
WP-1735	106	106	2700	4,75
WP-1736	116	116	3150	4,75
WP-1737	116	116	4350	4,75
WP-1738	104	105X	600	4,75
WP-1739	105	104X	1200	4,75
WP-1740	105	104X	1950	4,75
WP-1741	104X	110X	300	4,75
WP-1742	104X	110X	3250	4,75
WP-1743	105	1055	650	4,75
WP-1744	105	1055	1300	4,75
WP-1745	105	105X	550	4,75
WP-1746	105	105X	950	4,75
WP-1747	105	105X	1650	4,75
WP-1748	105	105X	1800	4,75
WP-1749	105	105X	1900	4,75
WP-1750	102	102	150	6,00
WP-1751	102	102	200	6,00
WP-1752	102	102	250	6,00
WP-1753	102	102	300	6,00
WP-1754	102	102	350	6,00
WP-1755	102	102	400	6,00
WP-1756	102	102	450	6,00
WP-1757	102	102	500	6,00
WP-1758	102	102	550	6,00
WP-1759	102	102	600	6,00
WP-1760	102	102	650	6,00
WP-1761	102	102	700	6,00
WP-1762	102	102	750	6,00
WP-1763	102	102	800	6,00
WP-1764	102	102	850	6,00
WP-1765	102	102	900	6,00
WP-1766	102	102	950	6,00
WP-1767	102	102	1000	6,00
WP-1768	102	102	1100	6,00
WP-1769	102	102	1200	6,00
WP-1770	102	102	1300	6,00
WP-1771	102	102	1400	6,00
WP-1772	102	102	1500	6,00
WP-1773	102	102	1600	6,00
WP-1774	102	102	1700	6,00
WP-1775	102	102	1800	6,00
WP-1776	102	102	1900	6,00
WP-1777	102	102	2000	6,00
WP-1778	102	102	2100	6,00
WP-1779	102	102	2200	6,00
WP-1780	102	102	2300	6,00
WP-1781	102	102	2400	6,00
WP-1782	102	102	2500	6,00
WP-1783	102	102	2600	6,00
WP-1784	102	102	2700	6,00
WP-1785	102	102	2800	6,00
WP-1786	102	102	2900	6,00

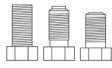
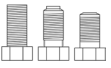
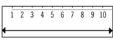
WP-1787	102	102	3000	6,00
WP-1788	102	102	3100	6,00
WP-1789	102	102	3200	6,00
WP-1790	102	102	3300	6,00
WP-1791	102	102	3400	6,00
WP-1792	102	102	3500	6,00
WP-1818	120	120	1200	3,50
WP-1819	120	120	1250	3,50
WP-1820	120	120	1300	3,50
WP-1820	120	120	1350	3,50
WP-1822	120	120	1400	3,50
WP-1823	120	120	1650	3,50
WP-1824	120	120	250	3,50
WP-1825	160	160	350	4,50
WP-1826	160	160	250	4,50
WP-1827	160	160	2500	4,50
WP-1828	160	160	930	4,50
WP-1829	160	160	630	4,50
WP-1830	160	160	1045	4,50
WP-1831	120	120	955	3,50
WP-1832	120	120	2635	3,50
WP-1833	120	120	510	3,50
WP-1834C	120	120	1100	3,50
WP-1835Y	120	120	1960	3,50
WP-1836	120	120	1085	3,50
WP-1836Y	120	120	1980	3,50
WP-1837	160	160	1240	4,50
WP-1838	120	120	465	3,50
WP-1839	120	120	3185	3,50
WP-1839a	120	120	3450	3,50
WP-1840	160	160	1250	4,50
WP-1841	160	160	1305	4,50
WP-1842	120	120	2970	3,50
WP-1842a	120	120	3300	3,50
WP-1843	160	160	1370	4,50
WP-1844	160	160	1410	4,50
WP-1845	120	120	940	3,50
WP-1846	120	120	595	3,50
WP-1847	120	120	310	3,50
WP-1848	160	160	1470	4,50
WP-1849	120	120	2820	3,50
WP-1850	160	160	1480	4,50
WP-1851	160	160	1510	4,50
WP-1852	160	160	500	4,50
WP-1853	160	160	230	4,50
WP-1854	160	160	360	4,50
WP-1855	160	160	660	4,50
WP-1856	120	120	2900	3,50
WP-1857	120	120	340	3,50
WP-1860	105	105X	1950	4,75
WP-1861	105	105X	2700	4,75
WP-1862	105	110X	800	4,75
WP-1863	105	110X	1450	4,75
WP-1864	105	110X	1500	4,75
WP-1866	105	110X	1850	4,75
WP-1867	105	110X	2200	4,75
WP-1868	105	110X	2350	4,75
WP-1869	105	110X	2650	4,75
WP-1870	105	110X	3100	4,75
WP-1871	105	110X	3350	4,75
WP-1872	105	110X	3600	4,75
WP-1873	105	110X	3650	4,75
WP-1874	105	116X	600	4,75
WP-1875	105X	106	2400	4,75
WP-1876	105X	116	1200	4,75
WP-1877	116	105X	1250	4,75
WP-1878	116	116X	1200	4,75
WP-1879	116	116X	2650	4,75
WP-1880	116	116X	3250	4,75
WP-1881	105	110X	3550	4,75
WP-1882	104	105X	750	4,75
WP-1883	106	106	280	4,75
WP-1884	112	112	190	4,75
WP-1885	112	112	3450	4,75
WP-1886	105	105	270	4,75
WP-1887	115	110X	100	4,75
WP-1888	105	106	4200	4,75
WP-1889	106	106	1000	4,75
WP-1890	104	106	850	4,75
WP-1891	105	107	2500	4,75
WP-1892	105X	116X	1250	4,75
WP-1893	112	112	200	4,75
WP-1894	112	112	420	4,75







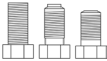
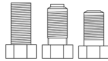

INDEKS INDEX ИНДЕКС	ZŁĄCZKA FITTING НАКОНЕЧНИК	ZŁĄCZKA FITTING НАКОНЕЧНИК	DŁUGOŚĆ W MM LENGHT IN MM ДЛИНА В ММ	ŚREDNICA RURY DIAMETER ДИАМЕТР ТРУБЫ	INDEKS INDEX ИНДЕКС	ZŁĄCZKA FITTING НАКОНЕЧНИК	ZŁĄCZKA FITTING НАКОНЕЧНИК	DŁUGOŚĆ W MM LENGHT IN MM ДЛИНА В ММ	ŚREDNICA RURY DIAMETER ДИАМЕТР ТРУБЫ
 WP-001					 WP-001				
WP-1895	112	112	440	4,75	WP-1982	120	120	3205	3,50
WP-1896	112	112	1670	4,75	WP-1983	120	120	1955	3,50
WP-1897	105	105	420	4,75	WP-1984	120	120	1385	3,50
WP-1898	104	1085	800	4,75	WP-1985	120	120	750	3,50
WP-1899	105	1085	1200	4,75	WP-1986	120	120	865	3,50
WP-1900	106	106	1250	4,75	WP-1987	120	120	330	3,50
WP-1901	120	120	1500	3,50	WP-1989	120	120	3785	3,50
WP-1902	120	120	2450	3,50	WP-1990	120	120	425	3,50
WP-1903	120	120	240	3,50	WP-1991	120	120	360	3,50
WP-1904	120	120	230	3,50	WP-1992	160	160	3320	4,50
WP-1905	120	120	2570	3,50	WP-1993	160	160	820	4,50
WP-1906	120	120	2530	3,50	WP-1994	160	160	1665	4,50
WP-1907	120	120	440	3,50	WP-1995	160	160	300	4,50
WP-1908	112	112	830	4,75	WP-1996	160	160	2200	4,50
WP-1909	112	112	210	4,75	WP-1997	160	160	4000	4,50
WP-1910	105	105	670	4,75	WP-1998	120	120	830	3,50
WP-1911	120	120	1600	3,50	WP-1998C	120	120	830	3,50
WP-1912	120	120	2400	3,50	WP-1998D	160	160	775	4,50
WP-1913	120	120	345	3,50	WP-1998E	160	160	750	4,50
WP-1914	120	120	350	3,50	WP-1998F	160	160	750	4,50
WP-1915	120	120	2800	3,50	WP-1999	160	160	940	4,50
WP-1920	105	116	100	4,75	WP-2000	160	160	580	4,50
WP-1921	112	113	420	4,75	WP-2001	160	160	240	4,50
WP-1922	112	113	430	4,75	WP-2002	160	160	2470	4,50
WP-1923	112	113	470	4,75	WP-2003	160	160	1940	4,50
WP-1924	112	113	580	4,75	WP-2950	105	106	2950	4,75
WP-1925	112	113	810	4,75	WP-2970	120	120	335	3,50
WP-1926	112	113	820	4,75	WP-2971	120	120	792	3,50
WP-1927	112	113	1680	4,75	WP-2971A	120	120	391	3,50
WP-1928	112	113	1815	4,75	WP-2973	105	105	786	4,75
WP-1929	113	113	560	4,75	WP-2974	105	105	1578	4,75
WP-1930	113	113	610	4,75	WP-2975	120	120	1938	3,50
WP-1931	112	112	340	4,75	WP-2976	120	120	2462	3,50
WP-1932	112	112	390	4,75	WP-2977	120	120	586	3,50
WP-1933	112	112	580	4,75	WP-2979	120	120	3985	3,50
WP-1934	112	112	1815	4,75	WP-2980	120	120	568	3,50
WP-1935	112	112	2335	4,75	WP-2981	120	120	925	3,50
WP-1936	105A	105A	235	4,75	WP-2981A	120	120	1147	3,50
WP-1911	120	120	1600	3,50	WP-2981B	120	120	1006	3,50
WP-1913	120	120	345	3,50	WP-2982	120	120	3690	3,50
WP-1970	120	120	425	3,50	WP-2983	120	120	1020	3,50
WP-1971	120	120	630	3,50	WP-2984	120	120	2201	3,50
WP-1972	120	120	3050	3,50	WP-2985	120	120	951	3,50
WP-1973	120	120	505	3,50	WP-2986	120	120	1085	3,50
WP-1974	120	120	1110	3,50	WP-2987	120	120	399	3,50
WP-1975	120	120	1800	3,50	WP-2988	120	120	440	3,50
WP-1976	120	120	2200	3,50	WP-2988A	120	120	271	3,50
WP-1979	120	120	3420	3,50	WP-2988B	120	120	201	3,50
WP-1979C	120	120	3100	3,50	WP-2989	120	120	3763	3,50
WP-1980	120	120	945	3,50	WP-2990	120	120	541	3,50
WP-1981	120	120	460	3,50	WP-2992	160	160	3307	4,50

Przewody hamulcowe
posortowane według złączek i długości

Brake lines
sorted by fittings and lengths

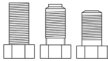
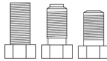





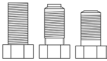
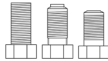

Выбор тормозных трубок
по длине трубки и наконечникам

ZŁĄCZKA FITTING НАКОНЕЧНИК	ZŁĄCZKA FITTING НАКОНЕЧНИК	DŁUGOŚĆ W MM LENGHT IN MM ДЛИНА В MM	INDEKS INDEX ИНДЕКС	ŚREDNICA RURY DIAMETER ДИАМЕТР ТРУБЫ	ZŁĄCZKA FITTING НАКОНЕЧНИК	ZŁĄCZKA FITTING НАКОНЕЧНИК	DŁUGOŚĆ W MM LENGHT IN MM ДЛИНА В MM	INDEKS INDEX ИНДЕКС	ŚREDNICA RURY DIAMETER ДИАМЕТР ТРУБЫ
102	102	150	WP-1750	6,00	103	103	3600	WP-628	6,35
102	102	200	WP-1751	6,00	103	103	3700	WP-642	6,35
102	102	250	WP-1752	6,00	103	103	4000	WP-630	6,35
102	102	300	WP-1753	6,00	104	104	150	WP-979	4,75
102	102	350	WP-1754	6,00	104	104	200	WP-540	4,75
102	102	400	WP-1755	6,00	104	104	250	WP-576	4,75
102	102	450	WP-1756	6,00	104	104	300	WP-723	4,75
102	102	500	WP-1757	6,00	104	104	350	WP-871	4,75
102	102	550	WP-1758	6,00	104	104	370	WP-1630	4,75
102	102	600	WP-1759	6,00	104	104	400	WP-1653	4,75
102	102	650	WP-1760	6,00	104	104	450	WP-577	4,75
102	102	700	WP-1761	6,00	104	104	500	WP-548	4,75
102	102	750	WP-1762	6,00	104	104	540	WP-1128	4,75
102	102	800	WP-1763	6,00	104	104	550	WP-582	4,75
102	102	850	WP-1764	6,00	104	104	580	WP-1143	4,75
102	102	900	WP-1765	6,00	104	104	600	WP-502	4,75
102	102	950	WP-1766	6,00	104	104	650	WP-1638	4,75
102	102	1000	WP-1767	6,00	104	104	700	WP-408	4,75
102	102	1100	WP-1768	6,00	104	104	750	WP-546	4,75
102	102	1200	WP-1769	6,00	104	104	800	WP-1660	4,75
102	102	1300	WP-1770	6,00	104	104	900	WP-541	4,75
102	102	1400	WP-1771	6,00	104	104	1000	WP-549	4,75
102	102	1500	WP-1772	6,00	104	104	1100	WP-872	4,75
102	102	1600	WP-1773	6,00	104	104	1150	WP-873	4,75
102	102	1700	WP-1774	6,00	104	104	1250	WP-543	4,75
102	102	1800	WP-1775	6,00	104	104	1500	WP-550	4,75
102	102	1900	WP-1776	6,00	104	104	1900	WP-583	4,75
102	102	2000	WP-1777	6,00	104	104	2000	WP-552	4,75
102	102	2100	WP-1778	6,00	104	104	2170	WP-1446	4,75
102	102	2200	WP-1779	6,00	104	104	2200	WP-542	4,75
102	102	2300	WP-1780	6,00	104	104	2500	WP-554	4,75
102	102	2400	WP-1781	6,00	104	104	2600	WP-786	4,75
102	102	2500	WP-1782	6,00	104	104	2650	WP-1723	4,75
102	102	2600	WP-1783	6,00	104	104	3000	WP-532	4,75
102	102	2700	WP-1784	6,00	104	104	3400	WP-545	4,75
102	102	2800	WP-1785	6,00	104	104	3500	WP-869	4,75
102	102	2900	WP-1786	6,00	104	104	3600	WP-1724	4,75
102	102	3000	WP-1787	6,00	104	104	4300	WP-510	4,75
102	102	3100	WP-1788	6,00	104	104	4550	WP-874	4,75
102	102	3200	WP-1789	6,00	104	104	4700	WP-980	4,75
102	102	3300	WP-1790	6,00	104	104	4800	WP-263	4,75
102	102	3400	WP-1791	6,00	104	104	5000	WP-1661	4,75
102	102	3500	WP-1792	6,00	104	104X	1250	WP-1319	4,75
103	103	180	WP-622	6,35	104	105	90	WP-1655	4,75
103	103	250	WP-643	6,35	104	105	100	WP-206	4,75
103	103	300	WP-634	6,35	104	105	150	WP-811	4,75
103	103	400	WP-639	6,35	104	105	200	WP-487	4,75
103	103	430	WP-644	6,35	104	105	250	WP-453	4,75
103	103	450	WP-631	6,35	104	105	300	WP-284	4,75
103	103	500	WP-612	6,35	104	105	350	WP-490	4,75
103	103	550	WP-615	6,35	104	105	400	WP-457	4,75
103	103	590	WP-624	6,35	104	105	420	WP-981	4,75
103	103	600	WP-605	6,35	104	105	450	WP-258	4,75
103	103	700	WP-613	6,35	104	105	500	WP-441	4,75
103	103	720	WP-625	6,35	104	105	550	WP-283	4,75
103	103	750	WP-611	6,35	104	105	560	WP-982	4,75
103	103	800	WP-610	6,35	104	105	570	WP-976	4,75
103	103	850	WP-606	6,35	104	105	600	WP-261	4,75
103	103	900	WP-607	6,35	104	105	650	WP-499	4,75
103	103	950	WP-633	6,35	104	105	700	WP-309	4,75
103	103	1000	WP-601	6,35	104	105	750	WP-264	4,75
103	103	1100	WP-616	6,35	104	105	800	WP-481	4,75
103	103	1200	WP-617	6,35	104	105	850	WP-260	4,75
103	103	1220	WP-623	6,35	104	105	900	WP-501	4,75
103	103	1300	WP-602	6,35	104	105	920	WP-983	4,75
103	103	1400	WP-621	6,35	104	105	950	WP-544	4,75
103	103	1450	WP-645	6,35	104	105	1000	WP-314	4,75
103	103	1500	WP-603	6,35	104	105	1050	WP-496	4,75
103	103	1600	WP-629	6,35	104	105	1100	WP-489	4,75
103	103	1700	WP-600	6,35	104	105	1150	WP-254	4,75
103	103	1800	WP-641	6,35	104	105	1200	WP-479	4,75
103	103	1900	WP-609	6,35	104	105	1250	WP-492	4,75
103	103	2000	WP-604	6,35	104	105	1300	WP-495	4,75
103	103	2050	WP-646	6,35	104	105	1350	WP-485	4,75
103	103	2200	WP-619	6,35	104	105	1400	WP-500	4,75
103	103	2500	WP-620	6,35	104	105	1450	WP-497	4,75
103	103	2600	WP-618	6,35	104	105	1500	WP-480	4,75
103	103	2700	WP-640	6,35	104	105	1550	WP-210	4,75
103	103	3000	WP-608	6,35	104	105	1600	WP-494	4,75
103	103	3100	WP-626	6,35	104	105	1650	WP-498	4,75
103	103	3200	WP-614	6,35	104	105	1700	WP-488	4,75
103	103	3400	WP-627	6,35	104	105	1750	WP-483	4,75
103	103	3500	WP-632	6,35	104	105	1800	WP-491	4,75

ZŁĄCZKA FITTING НАКОНЕЧНИК		ZŁĄCZKA FITTING НАКОНЕЧНИК		DŁUGOŚĆ W MM LENGHT IN MM ДЛИНА В MM		INDEKS INDEX ИНДЕКС		ŚREDNICA RURY DIAMETER ДИАМЕТР ТРУБЫ		ZŁĄCZKA FITTING НАКОНЕЧНИК		ZŁĄCZKA FITTING НАКОНЕЧНИК		DŁUGOŚĆ W MM LENGHT IN MM ДЛИНА В MM		INDEKS INDEX ИНДЕКС		ŚREDNICA RURY DIAMETER ДИАМЕТР ТРУБЫ		
																				
						WP- 001		4,75								WP- 001				
104	105	1850	WP-486	4,75	104	105A	2640	WP-1479	4,75											
104	105	1900	WP-266	4,75	104	105A	2710	WP-1486	4,75											
104	105	1950	WP-315	4,75	104	105A	2760	WP-1489	4,75											
104	105	2000	WP-484	4,75	104	105A	2900	WP-1499	4,75											
104	105	2100	WP-398	4,75	104	105A	3000	WP-1513	4,75											
104	105	2150	WP-1667	4,75	104	105A	3040	WP-1517	4,75											
104	105	2200	WP-584	4,75	104	105A	3140	WP-1525	4,75											
104	105	2250	WP-513	4,75	104	105A	3280	WP-1541	4,75											
104	105	2300	WP-399	4,75	104	105A	3430	WP-1551	4,75											
104	105	2400	WP-1708	4,75	104	105A	4000	WP-1586	4,75											
104	105	2500	WP-400	4,75	104	105A	4250	WP-1594	4,75											
104	105	2550	WP-1725	4,75	104	105A	4400	WP-1601	4,75											
104	105	2600	WP-1624	4,75	104	105A	4700	WP-1609	4,75											
104	105	2650	WP-585	4,75	104	105A	4900	WP-1615	4,75											
104	105	2700	WP-401	4,75	104	105A	4970	WP-1616	4,75											
104	105	2750	WP-586	4,75	104	105A	5340	WP-1618	4,75											
104	105	2800	WP-310	4,75	104	105D	430	WP-1087	4,75											
104	105	2900	WP-439	4,75	104	105D	485	WP-1109	4,75											
104	105	2950	WP-587	4,75	104	105D	530	WP-1124	4,75											
104	105	3000	WP-209	4,75	104	105D	630	WP-1156	4,75											
104	105	3050	WP-588	4,75	104	105D	700	WP-1180	4,75											
104	105	3100	WP-208	4,75	104	105D	750	WP-1192	4,75											
104	105	3150	WP-589	4,75	104	105D	810	WP-1207	4,75											
104	105	3200	WP-215	4,75	104	105D	850	WP-1220	4,75											
104	105	3300	WP-590	4,75	104	105D	1040	WP-1274	4,75											
104	105	3400	WP-1668	4,75	104	105D	1150	WP-1300	4,75											
104	105	3450	WP-591	4,75	104	105D	1890	WP-1409	4,75											
104	105	3500	WP-547	4,75	104	105D	2950	WP-1505	4,75											
104	105	3600	WP-255	4,75	104	105D	3600	WP-1563	4,75											
104	105	3650	WP-875	4,75	104	105D	3690	WP-1570	4,75											
104	105	3700	WP-308	4,75	104	105D	3820	WP-1578	4,75											
104	105	3750	WP-876	4,75	104	105D	4300	WP-1597	4,75											
104	105	3800	WP-1726	4,75	104	105D	4420	WP-1604	4,75											
104	105	3850	WP-592	4,75	104	105D	4750	WP-1610	4,75											
104	105	3950	WP-877	4,75	104	105X	600	WP-1738	4,75											
104	105	4000	WP-405	4,75	104	105X	750	WP-1882	4,75											
104	105	4100	WP-437	4,75	104	106	200	WP-477	4,75											
104	105	4150	WP-878	4,75	104	106	300	WP-217	4,75											
104	105	4250	WP-593	4,75	104	106	500	WP-879	4,75											
104	105	4300	WP-452	4,75	104	106	550	WP-880	4,75											
104	105	4400	WP-1625	4,75	104	106	580	WP-1144	4,75											
104	105	4450	WP-594	4,75	104	106	600	WP-565	4,75											
104	105	4500	WP-262	4,75	104	106	650	WP-1727	4,75											
104	105	4700	WP-451	4,75	104	106	740	WP-1186	4,75											
104	105	4750	WP-595	4,75	104	106	750	WP-105	4,75											
104	105	4800	WP-259	4,75	104	106	850	WP-1890	4,75											
104	105	4900	WP-313	4,75	104	106	860	WP-1224	4,75											
104	105	5000	WP-312	4,75	104	106	900	WP-512	4,75											
104	105	5350	WP-596	4,75	104	106	940	WP-1241	4,75											
104	105	5400	WP-316	4,75	104	106	950	WP-089	4,75											
104	105A	225	WP-1016	4,75	104	106	1000	WP-561	4,75											
104	105A	295	WP-1039	4,75	104	106	1050	WP-881	4,75											
104	105A	350	WP-1062	4,75	104	106	1200	WP-521	4,75											
104	105A	400	WP-1079	4,75	104	106	1280	WP-1325	4,75											
104	105A	485	WP-1108	4,75	104	106	1300	WP-524	4,75											
104	105A	500	WP-1113	4,75	104	106	1375	WP-1339	4,75											
104	105A	550	WP-1133	4,75	104	106	1400	WP-103	4,75											
104	105A	570	WP-1139	4,75	104	106	1420	WP-1346	4,75											
104	105A	580	WP-1142	4,75	104	106	1450	WP-597	4,75											
104	105A	630	WP-1155	4,75	104	106	1530	WP-1364	4,75											
104	105A	670	WP-1168	4,75	104	106	1550	WP-598	4,75											
104	105A	700	WP-1179	4,75	104	106	1600	WP-562	4,75											
104	105A	750	WP-1191	4,75	104	106	2070	WP-1434	4,75											
104	105A	830	WP-1214	4,75	104	106	2100	WP-599	4,75											
104	105A	900	WP-1234	4,75	104	106	2300	WP-1639	4,75											
104	105A	960	WP-1249	4,75	104	106	2400	WP-458	4,75											
104	105A	980	WP-1255	4,75	104	106	2400	WP-700	4,75											
104	105A	1000	WP-1260	4,75	104	106	2450	WP-882	4,75											
104	105A	1100	WP-1288	4,75	104	106	2500	WP-460	4,75											
104	105A	1120	WP-1293	4,75	104	106	2690	WP-1482	4,75											
104	105A	1190	WP-1306	4,75	104	106	2700	WP-092	4,75											
104	105A	1340	WP-1332	4,75	104	106	3150	WP-701	4,75											
104	105A	1420	WP-1345	4,75	104	106	3300	WP-503	4,75											
104	105A	1530	WP-1363	4,75	104	106	3500	WP-202	4,75											
104	105A	1600	WP-1377	4,75	104	106	3750	WP-883	4,75											
104	105A	1660	WP-1383	4,75	104	106	3950	WP-702	4,75											
104	105A	1780	WP-1398	4,75	104	106	4000	WP-201	4,75											
104	105A	1830	WP-1403	4,75	104	106	4250	WP-884	4,75											
104	105A	1940	WP-1417	4,75	104	107	450	WP-885	4,75											
104	105A	1970	WP-1422	4,75	104	107	500	WP-886	4,75											
104	105A	2080	WP-1436	4,75	104	107	950	WP-887	4,75											
104	105A	2160	WP-1445	4,75	104	108	1350	WP-888	4,75											
104	105A	2240	WP-1453	4,75	104	108	3200	WP-1669	4,75											

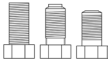
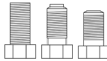
ZŁĄCZKA FITTING НАКОНЕЧНИК		ZŁĄCZKA FITTING НАКОНЕЧНИК		DŁUGOŚĆ W MM LENGHT IN MM ДЛИНА В MM		INDEKS INDEX ИНДЕКС		ŚREDNICA RURY DIAMETER ДИАМЕТР ТРУБЫ		ZŁĄCZKA FITTING НАКОНЕЧНИК		ZŁĄCZKA FITTING НАКОНЕЧНИК		DŁUGOŚĆ W MM LENGHT IN MM ДЛИНА В MM		INDEKS INDEX ИНДЕКС		ŚREDNICA RURY DIAMETER ДИАМЕТР ТРУБЫ	
104	108	3550	WP-889	4,75	105	105	620	WP-930	4,75										
104	108s	800	WP-1898	4,75	105	105	640	WP-945	4,75										
104	109	3100	WP-303	4,75	105	105	650	WP-018	4,75										
104	109	3200	WP-307	4,75	105	105	660	WP-1713	4,75										
104	110X	600	WP-1670	4,75	105	105	670	WP-1910	4,75										
104	110X	3300	WP-921	4,75	105	105	700	WP-033	4,75										
104	110X	3510	WP-1557	4,75	105	105	720	WP-932	4,75										
104	110X	3550	WP-829	4,75	105	105	750	WP-117	4,75										
104	110X	4000	WP-830	4,75	105	105	760	WP-931	4,75										
104	110X	4020	WP-1634	4,75	105	105	780	WP-1714	4,75										
104	116	410	WP-1082	4,75	105	105	786	WP-2973	4,75										
104	116	450	WP-703	4,75	105	105	800	WP-024	4,75										
104	116	700	WP-504	4,75	105	105	820	WP-989	4,75										
104	116	1400	WP-1650	4,75	105	105	850	WP-002	4,75										
104	116	1480	WP-1358	4,75	105	105	860	WP-933	4,75										
104	116	1500	WP-704	4,75	105	105	880	WP-1715	4,75										
104	116	1800	WP-518	4,75	105	105	900	WP-013	4,75										
104	116	4050	WP-1651	4,75	105	105	950	WP-265	4,75										
104	105	900	WP-1662	4,75	105	105	1000	WP-019	4,75										
104	105	1200	WP-1645	4,75	105	105	1010	WP-934	4,75										
104	105	1450	WP-1646	4,75	105	105	1050	WP-252	4,75										
104	104	630	WP-1647	4,75	105	105	1060	WP-935	4,75										
104	104	1250	WP-1648	4,75	105	105	1100	WP-035	4,75										
104X	104X	550	WP-831	4,75	105	105	1150	WP-115	4,75										
104X	104X	570	WP-1140	4,75	105	105	1190	WP-936	4,75										
104X	104X	600	WP-507	4,75	105	105	1200	WP-034	4,75										
104X	104X	650	WP-522	4,75	105	105	1250	WP-027	4,75										
104X	104X	800	WP-1206	4,75	105	105	1270	WP-946	4,75										
104X	104X	820	WP-1210	4,75	105	105	1300	WP-196	4,75										
104X	110X	300	WP-1741	4,75	105	105	1330	WP-947	4,75										
104X	110X	600	WP-511	4,75	105	105	1340	WP-937	4,75										
104X	110X	1150	WP-1700	4,75	105	105	1350	WP-022	4,75										
104X	110X	1200	WP-1701	4,75	105	105	1390	WP-948	4,75										
104X	110X	3250	WP-1742	4,75	105	105	1400	WP-003	4,75										
105	104X	300	WP-1696	4,75	105	105	1450	WP-356	4,75										
105	104X	600	WP-505	4,75	105	105	1480	WP-938	4,75										
105	104X	850	WP-832	4,75	105	105	1490	WP-949	4,75										
105	104X	950	WP-833	4,75	105	105	1500	WP-047	4,75										
105	104X	1000	WP-523	4,75	105	105	1550	WP-039	4,75										
105	104X	1050	WP-1697	4,75	105	105	1560	WP-1716	4,75										
105	104X	1200	WP-1739	4,75	105	105	1578	WP-2974	4,75										
105	104X	1250	WP-506	4,75	105	105	1600	WP-435	4,75										
105	104X	1350	WP-528	4,75	105	105	1650	WP-012	4,75										
105	104X	1750	WP-1698	4,75	105	105	1660	WP-1717	4,75										
105	104X	1950	WP-1740	4,75	105	105	1700	WP-042	4,75										
105	104X	2500	WP-834	4,75	105	105	1750	WP-256	4,75										
105	104X	2950	WP-514	4,75	105	105	1800	WP-023	4,75										
105	104X	3000	WP-531	4,75	105	105	1820	WP-1626	4,75										
105	104X	3400	WP-1699	4,75	105	105	1850	WP-010	4,75										
105	105	90	WP-984	4,75	105	105	1900	WP-049	4,75										
105	105	100	WP-705	4,75	105	105	1950	WP-482	4,75										
105	105	130	WP-478	4,75	105	105	2000	WP-331	4,75										
105	105	150	WP-205	4,75	105	105	2050	WP-428	4,75										
105	105	160	WP-1644	4,75	105	105	2100	WP-036	4,75										
105	105	180	WP-555	4,75	105	105	2150	WP-440	4,75										
105	105	190	WP-1656	4,75	105	105	2170	WP-950	4,75										
105	105	200	WP-043	4,75	105	105	2200	WP-031	4,75										
105	105	250	WP-006	4,75	105	105	2250	WP-390	4,75										
105	105	260	WP-724	4,75	105	105	2300	WP-011	4,75										
105	105	270	WP-1886	4,75	105	105	2350	WP-559	4,75										
105	105	280	WP-939	4,75	105	105	2400	WP-014	4,75										
105	105	290	WP-725	4,75	105	105	2450	WP-706	4,75										
105	105	300	WP-001	4,75	105	105	2500	WP-048	4,75										
105	105	320	WP-806	4,75	105	105	2550	WP-404	4,75										
105	105	350	WP-041	4,75	105	105	2600	WP-167	4,75										
105	105	360	WP-807	4,75	105	105	2650	WP-707	4,75										
105	105	370	WP-940	4,75	105	105	2700	WP-015	4,75										
105	105	400	WP-045	4,75	105	105	2750	WP-533	4,75										
105	105	410	WP-941	4,75	105	105	2800	WP-032	4,75										
105	105	420	WP-1897	4,75	105	105	2850	WP-708	4,75										
105	105	430	WP-942	4,75	105	105	2900	WP-016	4,75										
105	105	440	WP-808	4,75	105	105	2950	WP-433	4,75										
105	105	450	WP-005	4,75	105	105	3000	WP-008	4,75										
105	105	460	WP-927	4,75	105	105	3020	WP-985	4,75										
105	105	490	WP-943	4,75	105	105	3050	WP-475	4,75										
105	105	500	WP-017	4,75	105	105	3100	WP-004	4,75										
105	105	510	WP-928	4,75	105	105	3150	WP-709	4,75										
105	105	520	WP-990	4,75	105	105	3200	WP-029	4,75										
105	105	550	WP-028	4,75	105	105	3250	WP-432	4,75										
105	105	560	WP-929	4,75	105	105	3300	WP-040	4,75										
105	105	560	WP-944	4,75	105	105	3350	WP-890	4,75										
105	105	580	WP-1712	4,75	105	105	3400	WP-020	4,75										
105	105	600	WP-009	4,75	105	105	3450	WP-710	4,75										







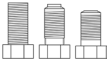
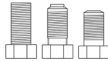

ZŁĄCZKA FITTING НАКОНЕЧНИК	ZŁĄCZKA FITTING НАКОНЕЧНИК	DŁUGOŚĆ W MM LENGHT IN MM ДЛИНА В MM	INDEKS INDEX ИНДЕКС	ŚREDNICA RURY DIAMETER ДИАМЕТР ТРУБЫ	ZŁĄCZKA FITTING НАКОНЕЧНИК	ZŁĄCZKA FITTING НАКОНЕЧНИК	DŁUGOŚĆ W MM LENGHT IN MM ДЛИНА В MM	INDEKS INDEX ИНДЕКС	ŚREDNICA RURY DIAMETER ДИАМЕТР ТРУБЫ
105	105	3500	WP-046	4,75	105	106	1000	WP-104	4,75
105	105	3550	WP-711	4,75	105	106	1050	WP-386	4,75
105	105	3600	WP-021	4,75	105	106	1100	WP-109	4,75
105	105	3650	WP-891	4,75	105	106	1150	WP-186	4,75
105	105	3700	WP-030	4,75	105	106	1200	WP-387	4,75
105	105	3750	WP-534	4,75	105	106	1250	WP-188	4,75
105	105	3800	WP-038	4,75	105	106	1300	WP-107	4,75
105	105	3850	WP-571	4,75	105	106	1350	WP-198	4,75
105	105	3900	WP-007	4,75	105	106	1400	WP-194	4,75
105	105	3950	WP-892	4,75	105	106	1450	WP-216	4,75
105	105	4000	WP-358	4,75	105	106	1500	WP-459	4,75
105	105	4050	WP-712	4,75	105	106	1550	WP-112	4,75
105	105	4100	WP-050	4,75	105	106	1600	WP-207	4,75
105	105	4150	WP-893	4,75	105	106	1650	WP-1671	4,75
105	105	4200	WP-253	4,75	105	106	1700	WP-190	4,75
105	105	4220	WP-1718	4,75	105	106	1750	WP-197	4,75
105	105	4300	WP-025	4,75	105	106	1800	WP-715	4,75
105	105	4320	WP-1719	4,75	105	106	1850	WP-113	4,75
105	105	4400	WP-026	4,75	105	106	1900	WP-200	4,75
105	105	4420	WP-1720	4,75	105	106	1950	WP-520	4,75
105	105	4450	WP-438	4,75	105	106	2000	WP-175	4,75
105	105	4500	WP-257	4,75	105	106	2050	WP-560	4,75
105	105	4550	WP-894	4,75	105	106	2100	WP-193	4,75
105	105	4600	WP-713	4,75	105	106	2150	WP-716	4,75
105	105	4700	WP-476	4,75	105	106	2200	WP-187	4,75
105	105	4800	WP-44	4,75	105	106	2300	WP-445	4,75
105	105	4850	WP-895	4,75	105	106	2350	WP-717	4,75
105	105	4900	WP-436	4,75	105	106	2400	WP-455	4,75
105	105	5000	WP-392	4,75	105	106	2450	WP-1672	4,75
105	105	5100	WP-714	4,75	105	106	2500	WP-563	4,75
105	105	5400	WP-1631	4,75	105	106	2600	WP-456	4,75
105	105	5600	WP-1632	4,75	105	106	2700	WP-1673	4,75
105	105	5800	WP-391	4,75	105	106	2750	WP-526	4,75
105	105	6000	WP-1633	4,75	105	106	2800	WP-529	4,75
105	105S	650	WP-1743	4,75	105	106	2950	WP-1674	4,75
105	105S	1300	WP-1744	4,75	105	106	3000	WP-093	4,75
105	105X	500	WP-558	4,75	105	106	3100	WP-191	4,75
105	105X	550	WP-1745	4,75	105	106	3200	WP-328	4,75
105	105X	600	WP-922	4,75	105	106	3200	WP-517	4,75
105	105X	700	WP-556	4,75	105	106	3250	WP-566	4,75
105	105X	800	WP-835	4,75	105	106	3300	WP-446	4,75
105	105X	850	WP-836	4,75	105	106	3350	WP-896	4,75
105	105X	950	WP-1746	4,75	105	106	3400	WP-192	4,75
105	105X	1000	WP-837	4,75	105	106	3500	WP-204	4,75
105	105X	1050	WP-838	4,75	105	106	3550	WP-718	4,75
105	105X	1100	WP-557	4,75	105	106	3600	WP-447	4,75
105	105X	1200	WP-839	4,75	105	106	3650	WP-719	4,75
105	105X	1250	WP-493	4,75	105	106	3700	WP-176	4,75
105	105X	1300	WP-923	4,75	105	106	3950	WP-572	4,75
105	105X	1350	WP-840	4,75	105	106	4000	WP-203	4,75
105	105X	1600	WP-841	4,75	105	106	4200	WP-1888	4,75
105	105X	1650	WP-1747	4,75	105	107	550	WP-443	4,75
105	105X	1800	WP-1748	4,75	105	107	650	WP-720	4,75
105	105X	1900	WP-1749	4,75	105	107	700	WP-721	4,75
105	105X	1950	WP-1860	4,75	105	107	800	WP-037	4,75
105	105X	2700	WP-1861	4,75	105	107	900	WP-1619	4,75
105	106	100	WP-1711	4,75	105	107	1000	WP-442	4,75
105	106	140	WP-966	4,75	105	107	1100	WP-1627	4,75
105	106	150	WP-088	4,75	105	107	1200	WP-1640	4,75
105	106	180	WP-967	4,75	105	107	1450	WP-1641	4,75
105	106	200	WP-101	4,75	105	107	2500	WP-1891	4,75
105	106	240	WP-968	4,75	105	107	2950	WP-1728	4,75
105	106	250	WP-091	4,75	105	107	3200	WP-722	4,75
105	106	290	WP-969	4,75	105	107	3300	WP-213	4,75
105	106	300	WP-111	4,75	105	108	300	WP-897	4,75
105	106	350	WP-114	4,75	105	108	450	WP-388	4,75
105	106	380	WP-970	4,75	105	108	900	WP-898	4,75
105	106	400	WP-108	4,75	105	108	1050	WP-389	4,75
105	106	420	WP-1657	4,75	105	108	1150	WP-899	4,75
105	106	440	WP-1658	4,75	105	108	1300	WP-900	4,75
105	106	450	WP-385	4,75	105	108	1900	WP-901	4,75
105	106	500	WP-384	4,75	105	108	2500	WP-1729	4,75
105	106	510	WP-971	4,75	105	108	2900	WP-902	4,75
105	106	550	WP-110	4,75	105	108	2950	WP-1730	4,75
105	106	600	WP-396	4,75	105	108	3500	WP-1675	4,75
105	106	650	WP-090	4,75	105	108s	1200	WP-1899	4,75
105	106	660	WP-972	4,75	105	109	200	WP-472	4,75
105	106	700	WP-195	4,75	105	109	250	WP-473	4,75
105	106	750	WP-174	4,75	105	109	300	WP-474	4,75
105	106	800	WP-102	4,75	105	109	1900	WP-471	4,75
105	106	850	WP-448	4,75	105	110	150	WP-726	4,75
105	106	900	WP-199	4,75	105	110	250	WP-338	4,75
105	106	950	WP-444	4,75	105	110	650	WP-727	4,75

ZŁĄCZKA FITTING НАКОНЕЧНИК		ZŁĄCZKA FITTING НАКОНЕЧНИК		DŁUGOŚĆ W MM LENGHT IN MM ДЛИНА В MM		INDEKS INDEX ИНДЕКС		ŚREDNICA RURY DIAMETER ДИАМЕТР ТРУБЫ		ZŁĄCZKA FITTING НАКОНЕЧНИК		ZŁĄCZKA FITTING НАКОНЕЧНИК		DŁUGOŚĆ W MM LENGHT IN MM ДЛИНА В MM		INDEKS INDEX ИНДЕКС		ŚREDNICA RURY DIAMETER ДИАМЕТР ТРУБЫ	
																			
WP- 001		WP- 001						4,75		WP- 001		WP- 001						4,75	
105	110	1500	WP-728	4,75	105	116	1400	WP-907	4,75										
105	110	1650	WP-337	4,75	105	116	1450	WP-351	4,75										
105	110	2500	WP-339	4,75	105	116	1500	WP-908	4,75										
105	110	3150	WP-729	4,75	105	116	1600	WP-1731	4,75										
105	110X	800	WP-1862	4,75	105	116	1900	WP-870	4,75										
105	110X	850	WP-1678	4,75	105	116	1950	WP-744	4,75										
105	110X	1000	WP-1679	4,75	105	116	2000	WP-909	4,75										
105	110X	1050	WP-1680	4,75	105	116	2050	WP-745	4,75										
105	110X	1150	WP-1681	4,75	105	116	2100	WP-462	4,75										
105	110X	1350	WP-1704	4,75	105	116	2150	WP-527	4,75										
105	110X	1400	WP-842	4,75	105	116	2200	WP-910	4,75										
105	110X	1450	WP-1863	4,75	105	116	2250	WP-1676	4,75										
105	110X	1500	WP-1864	4,75	105	116	2400	WP-911	4,75										
105	110X	1550	WP-1865	4,75	105	116	2500	WP-1732	4,75										
105	110X	1650	WP-1682	4,75	105	116	2800	WP-1677	4,75										
105	110X	1750	WP-1683	4,75	105	116	2950	WP-746	4,75										
105	110X	1850	WP-1866	4,75	105	116	3000	WP-747	4,75										
105	110X	2150	WP-1684	4,75	105	116	3020	WP-1636	4,75										
105	110X	2200	WP-1867	4,75	105	116	3100	WP-748	4,75										
105	110X	2250	WP-843	4,75	105	116	3250	WP-530	4,75										
105	110X	2300	WP-1705	4,75	105	116	3350	WP-1733	4,75										
105	110X	2350	WP-1868	4,75	105	116	3400	WP-749	4,75										
105	110X	2650	WP-1869	4,75	105	116	3450	WP-750	4,75										
105	110X	2750	WP-1685	4,75	105	116	3480	WP-977	4,75										
105	110X	2800	WP-1686	4,75	105	116	3500	WP-347	4,75										
105	110X	2900	WP-519	4,75	105	116	3600	WP-751	4,75										
105	110X	3000	WP-525	4,75	105	116	3650	WP-752	4,75										
105	110X	3100	WP-1870	4,75	105	116	3700	WP-349	4,75										
105	110X	3250	WP-1687	4,75	105	116	3800	WP-352	4,75										
105	110X	3300	WP-844	4,75	105	116	3900	WP-912	4,75										
105	110X	3350	WP-1871	4,75	105	116	4250	WP-753	4,75										
105	110X	3550	WP-1881	4,75	105	116	4380	WP-978	4,75										
105	110X	3600	WP-1706	4,75	105	116	4400	WP-754	4,75										
105	110X	3600	WP-1872	4,75	105	116	4420	WP-1635	4,75										
105	110X	3650	WP-1873	4,75	105	116	4450	WP-755	4,75										
105	110X	3900	WP-845	4,75	105	116	4500	WP-348	4,75										
105	110X	3950	WP-924	4,75	105	116	4550	WP-756	4,75										
105	110X	4100	WP-1707	4,75	105	116	4600	WP-350	4,75										
105	112	150	WP-465	4,75	105	116	4650	WP-913	4,75										
105	112	200	WP-415	4,75	105	116	4750	WP-757	4,75										
105	112	250	WP-1654	4,75	105	116X	300	WP-846	4,75										
105	112	550	WP-394	4,75	105	116X	550	WP-847	4,75										
105	112	600	WP-730	4,75	105	116X	600	WP-1874	4,75										
105	112	650	WP-539	4,75	105	116X	3200	WP-848	4,75										
105	112	700	WP-731	4,75	105	116X	3300	WP-1688	4,75										
105	112	750	WP-536	4,75	105	116X	4500	WP-1689	4,75										
105	112	900	WP-403	4,75	105	118	900	WP-416	4,75										
105	112	1050	WP-538	4,75	105	118	1100	WP-418	4,75										
105	112	1100	WP-395	4,75	105	118	1600	WP-419	4,75										
105	112	1150	WP-732	4,75	105	118	2400	WP-417	4,75										
105	112	1300	WP-535	4,75	105A	104X	600	WP-1147	4,75										
105	112	1350	WP-733	4,75	105A	104X	1000	WP-1261	4,75										
105	112	2000	WP-420	4,75	105A	104X	1250	WP-1320	4,75										
105	112	2200	WP-464	4,75	105A	104X	1350	WP-1335	4,75										
105	112	2250	WP-734	4,75	105A	104X	1710	WP-1391	4,75										
105	112	3500	WP-414	4,75	105A	104X	2950	WP-1506	4,75										
105	112	3800	WP-537	4,75	105A	104X	3000	WP-1514	4,75										
105	112	4000	WP-397	4,75	105A	105A	100	WP-995	4,75										
105	113	1100	WP-903	4,75	105A	105A	115	WP-996	4,75										
105	116	100	WP-1920	4,75	105A	105A	140	WP-997	4,75										
105	116	150	WP-357	4,75	105A	105A	150	WP-1001	4,75										
105	116	200	WP-904	4,75	105A	105A	170	WP-1006	4,75										
105	116	250	WP-735	4,75	105A	105A	180	WP-1007	4,75										
105	116	300	WP-578	4,75	105A	105A	200	WP-1013	4,75										
105	116	350	WP-354	4,75	105A	105A	210	WP-1014	4,75										
105	116	400	WP-579	4,75	105A	105A	235	WP-1936	4,75										
105	116	450	WP-905	4,75	105A	105A	240	WP-1019	4,75										
105	116	500	WP-736	4,75	105A	105A	260	WP-1026	4,75										
105	116	550	WP-737	4,75	105A	105A	290	WP-1035	4,75										
105	116	600	WP-906	4,75	105A	105A	300	WP-1041	4,75										
105	116	700	WP-738	4,75	105A	105A	320	WP-1048	4,75										
105	116	750	WP-515	4,75	105A	105A	330	WP-1052	4,75										
105	116	850	WP-739	4,75	105A	105A	350	WP-1060	4,75										
105	116	900	WP-346	4,75	105A	105A	360	WP-1063	4,75										
105	116	950	WP-353	4,75	105A	105A	380	WP-1071	4,75										
105	116	1000	WP-740	4,75	105A	105A	390	WP-1073	4,75										
105	116	1050	WP-741	4,75	105A	105A	400	WP-1077	4,75										
105	116	1100	WP-461	4,75	105A	105A	410	WP-1081	4,75										
105	116	1150	WP-355	4,75	105A	105A	420	WP-1085	4,75										
105	116	1200	WP-742	4,75	105A	105A	440	WP-1091	4,75										
105	116	1250	WP-743	4,75	105A	105A	460	WP-1096	4,75										
105	116	1300	WP-580	4,75	105A	105A	480	WP-1103	4,75										
105	116	1350	WP-463	4,75	105A	105A	500	WP-1112	4,75										



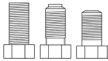
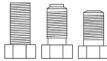





ZŁĄCZKA FITTING НАКОНЕЧНИК	ZŁĄCZKA FITTING НАКОНЕЧНИК	DŁUGOŚĆ W MM LENGHT IN MM ДЛИНА В MM	INDEKS INDEX ИНДЕКС	ŚREDNICA RURY DIAMETER ДИАМЕТР ТРУБЫ	ZŁĄCZKA FITTING НАКОНЕЧНИК	ZŁĄCZKA FITTING НАКОНЕЧНИК	DŁUGOŚĆ W MM LENGHT IN MM ДЛИНА В MM	INDEKS INDEX ИНДЕКС	ŚREDNICA RURY DIAMETER ДИАМЕТР ТРУБЫ
105A	105A	510	WP-1115	4,75	105A	105A	3500	WP-1555	4,75
105A	105A	520	WP-1119	4,75	105A	105A	3530	WP-1559	4,75
105A	105A	540	WP-1127	4,75	105A	105A	3600	WP-1562	4,75
105A	105A	560	WP-1135	4,75	105A	105A	3700	WP-1571	4,75
105A	105A	570	WP-1137	4,75	105A	105A	3750	WP-1573	4,75
105A	105A	590	WP-1146	4,75	105A	105A	3820	WP-1577	4,75
105A	105A	610	WP-1149	4,75	105A	105A	3900	WP-1580	4,75
105A	105A	620	WP-1151	4,75	105A	105A	3960	WP-1583	4,75
105A	105A	650	WP-1163	4,75	105A	105A	4000	WP-1585	4,75
105A	105A	670	WP-1167	4,75	105A	105A	4050	WP-1588	4,75
105A	105A	700	WP-1178	4,75	105A	105A	4100	WP-1591	4,75
105A	105A	720	WP-1183	4,75	105A	105A	4200	WP-1592	4,75
105A	105A	760	WP-1196	4,75	105A	105A	4300	WP-1596	4,75
105A	105A	780	WP-1200	4,75	105A	105A	4410	WP-1602	4,75
105A	105A	800	WP-1205	4,75	105A	105A	4800	WP-1612	4,75
105A	105A	820	WP-1209	4,75	105A	105A	4880	WP-1614	4,75
105A	105A	860	WP-1223	4,75	105A	105A	5070	WP-1617	4,75
105A	105A	880	WP-1228	4,75	105A	105X	840	WP-1215	4,75
105A	105A	900	WP-1232	4,75	105A	110X	3000	WP-1512	4,75
105A	105A	920	WP-1236	4,75	105D	105D	160	WP-1003	4,75
105A	105A	960	WP-1247	4,75	105D	105D	180	WP-1009	4,75
105A	105A	980	WP-1254	4,75	105D	105D	260	WP-1028	4,75
105A	105A	1000	WP-1259	4,75	105D	105D	270	WP-1622	4,75
105A	105A	1010	WP-1264	4,75	105D	105D	280	WP-1032	4,75
105A	105A	1040	WP-1273	4,75	105D	105D	290	WP-1037	4,75
105A	105A	1060	WP-1278	4,75	105D	105D	310	WP-1045	4,75
105A	105A	1100	WP-1286	4,75	105D	105D	315	WP-1047	4,75
105A	105A	1110	WP-1291	4,75	105D	105D	340	WP-1057	4,75
105A	105A	1150	WP-1298	4,75	105D	105D	370	WP-1067	4,75
105A	105A	1190	WP-1305	4,75	105D	105D	390	WP-1074	4,75
105A	105A	1220	WP-1310	4,75	105D	105D	410	WP-1083	4,75
105A	105A	1250	WP-1318	4,75	105D	105D	420	WP-1086	4,75
105A	105A	1300	WP-1327	4,75	105D	105D	430	WP-1088	4,75
105A	105A	1340	WP-1331	4,75	105D	105D	450	WP-1095	4,75
105A	105A	1370	WP-1337	4,75	105D	105D	460	WP-1098	4,75
105A	105A	1385	WP-1341	4,75	105D	105D	490	WP-1110	4,75
105A	105A	1400	WP-1344	4,75	105D	105D	520	WP-1120	4,75
105A	105A	1430	WP-1348	4,75	105D	105D	540	WP-1129	4,75
105A	105A	1440	WP-1351	4,75	105D	105D	550	WP-1134	4,75
105A	105A	1460	WP-1356	4,75	105D	105D	560	WP-1136	4,75
105A	105A	1480	WP-1357	4,75	105D	105D	575	WP-1141	4,75
105A	105A	1500	WP-1360	4,75	105D	105D	600	WP-1148	4,75
105A	105A	1530	WP-1362	4,75	105D	105D	610	WP-1150	4,75
105A	105A	1550	WP-1368	4,75	105D	105D	620	WP-1154	4,75
105A	105A	1580	WP-1373	4,75	105D	105D	640	WP-1159	4,75
105A	105A	1600	WP-1376	4,75	105D	105D	680	WP-1171	4,75
105A	105A	1630	WP-1379	4,75	105D	105D	710	WP-1181	4,75
105A	105A	1660	WP-1382	4,75	105D	105D	750	WP-1193	4,75
105A	105A	1700	WP-1390	4,75	105D	105D	780	WP-1202	4,75
105A	105A	1760	WP-1397	4,75	105D	105D	820	WP-1211	4,75
105A	105A	1790	WP-1399	4,75	105D	105D	850	WP-1221	4,75
105A	105A	1815	WP-1401	4,75	105D	105D	900	WP-1235	4,75
105A	105A	1860	WP-1406	4,75	105D	105D	920	WP-1237	4,75
105A	105A	1900	WP-1412	4,75	105D	105D	950	WP-1245	4,75
105A	105A	1950	WP-1421	4,75	105D	105D	980	WP-1256	4,75
105A	105A	2010	WP-1425	4,75	105D	105D	1000	WP-1262	4,75
105A	105A	2050	WP-1430	4,75	105D	105D	1040	WP-1275	4,75
105A	105A	2080	WP-1435	4,75	105D	105D	1100	WP-1289	4,75
105A	105A	2140	WP-1443	4,75	105D	105D	1140	WP-1296	4,75
105A	105A	2200	WP-1448	4,75	105D	105D	1180	WP-1304	4,75
105A	105A	2250	WP-1454	4,75	105D	105D	1210	WP-1309	4,75
105A	105A	2300	WP-1457	4,75	105D	105D	1240	WP-1315	4,75
105A	105A	2350	WP-1460	4,75	105D	105D	1270	WP-1324	4,75
105A	105A	2400	WP-1463	4,75	105D	105D	1330	WP-1330	4,75
105A	105A	2440	WP-1465	4,75	105D	105D	1390	WP-1343	4,75
105A	105A	2500	WP-1468	4,75	105D	105D	1430	WP-1349	4,75
105A	105A	2550	WP-1472	4,75	105D	105D	1450	WP-1354	4,75
105A	105A	2600	WP-1476	4,75	105D	105D	1490	WP-1359	4,75
105A	105A	2625	WP-1478	4,75	105D	105D	1550	WP-1369	4,75
105A	105A	2700	WP-1484	4,75	105D	105D	1630	WP-1380	4,75
105A	105A	2750	WP-1488	4,75	105D	105D	1660	WP-1384	4,75
105A	105A	2800	WP-1491	4,75	105D	105D	1720	WP-1392	4,75
105A	105A	2850	WP-1495	4,75	105D	105D	1800	WP-1400	4,75
105A	105A	2900	WP-1498	4,75	105D	105D	1820	WP-1402	4,75
105A	105A	3000	WP-1510	4,75	105D	105D	1890	WP-1410	4,75
105A	105A	3050	WP-1518	4,75	105D	105D	1900	WP-1414	4,75
105A	105A	3100	WP-1521	4,75	105D	105D	1940	WP-1418	4,75
105A	105A	3150	WP-1526	4,75	105D	105D	1980	WP-1424	4,75
105A	105A	3200	WP-1529	4,75	105D	105D	2020	WP-1426	4,75
105A	105A	3240	WP-1537	4,75	105D	105D	2060	WP-1432	4,75
105A	105A	3300	WP-1543	4,75	105D	105D	2100	WP-1439	4,75
105A	105A	3400	WP-1548	4,75	105D	105D	2150	WP-1444	4,75
105A	105A	3450	WP-1552	4,75	105D	105D	2170	WP-1447	4,75

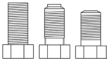
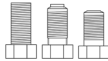



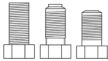
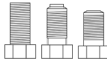

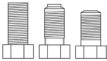
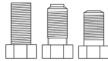

ZŁĄCZKA FITTING НАКОНЕЧНИК	ZŁĄCZKA FITTING НАКОНЕЧНИК	DŁUGOŚĆ W MM LENGHT IN MM ДЛИНА В MM	INDEKS INDEX ИНДЕКС	ŚREDNICA RURY DIAMETER ДИАМЕТР ТРУБЫ	ZŁĄCZKA FITTING НАКОНЕЧНИК	ZŁĄCZKA FITTING НАКОНЕЧНИК	DŁUGOŚĆ W MM LENGHT IN MM ДЛИНА В MM	INDEKS INDEX ИНДЕКС	ŚREDNICA RURY DIAMETER ДИАМЕТР ТРУБЫ
105D	105D	2250	WP-1455	4,75	106	105A	2040	WP-1429	4,75
105D	105D	2350	WP-1462	4,75	106	105A	2120	WP-1441	4,75
105D	105D	2400	WP-1464	4,75	106	105A	2200	WP-1449	4,75
105D	105D	2450	WP-1466	4,75	106	105A	2300	WP-1458	4,75
105D	105D	2500	WP-1470	4,75	106	105A	2350	WP-1461	4,75
105D	105D	2600	WP-1623	4,75	106	105A	2500	WP-1469	4,75
105D	105D	2650	WP-1480	4,75	106	105A	2600	WP-1477	4,75
105D	105D	2700	WP-1485	4,75	106	105A	2730	WP-1487	4,75
105D	105D	2800	WP-1493	4,75	106	105A	2800	WP-1492	4,75
105D	105D	2850	WP-1496	4,75	106	105A	3000	WP-1511	4,75
105D	105D	2900	WP-1500	4,75	106	105A	3100	WP-1522	4,75
105D	105D	2950	WP-1504	4,75	106	105A	3200	WP-1530	4,75
105D	105D	2950	WP-1507	4,75	106	105A	3250	WP-1539	4,75
105D	105D	3000	WP-1515	4,75	106	105A	3300	WP-1544	4,75
105D	105D	3060	WP-1519	4,75	106	105A	3400	WP-1549	4,75
105D	105D	3130	WP-1524	4,75	106	105A	3550	WP-1560	4,75
105D	105D	3200	WP-1532	4,75	106	105A	3630	WP-1566	4,75
105D	105D	3300	WP-1545	4,75	106	105A	3680	WP-1569	4,75
105D	105D	3500	WP-1556	4,75	106	105A	3950	WP-1582	4,75
105D	105D	3600	WP-1564	4,75	106	106	90	WP-1628	4,75
105D	105D	3700	WP-1572	4,75	106	106	150	WP-393	4,75
105D	105D	4050	WP-1589	4,75	106	106	200	WP-573	4,75
105D	105D	4200	WP-1593	4,75	106	106	280	WP-1883	4,75
105D	105D	4300	WP-1598	4,75	106	106	390	WP-1075	4,75
105D	105D	4500	WP-1606	4,75	106	106	400	WP-758	4,75
105D	105D	4800	WP-1613	4,75	106	106	450	WP-211	4,75
105D	105X	480	WP-1104	4,75	106	106	500	WP-1659	4,75
105D	105X	500	WP-1114	4,75	106	106	550	WP-759	4,75
105D	105X	670	WP-1169	4,75	106	106	600	WP-214	4,75
105D	105X	690	WP-1176	4,75	106	106	700	WP-1690	4,75
105D	105X	780	WP-1203	4,75	106	106	750	WP-760	4,75
105D	105X	850	WP-1222	4,75	106	106	900	WP-1691	4,75
105D	105X	1000	WP-1263	4,75	106	106	1000	WP-1889	4,75
105D	105X	1020	WP-1267	4,75	106	106	1200	WP-1900	4,75
105D	105X	1060	WP-1279	4,75	106	106	1800	WP-761	4,75
105D	105X	1200	WP-1307	4,75	106	106	1850	WP-212	4,75
105D	105X	1240	WP-1316	4,75	106	106	1900	WP-1734	4,75
105D	105X	1340	WP-1333	4,75	106	106	2080	WP-1437	4,75
105D	105X	1560	WP-1370	4,75	106	106	2100	WP-762	4,75
105D	110X	3270	WP-1540	4,75	106	106	2235	WP-1452	4,75
105D	110X	3900	WP-1581	4,75	106	106	2250	WP-763	4,75
105D	116X	300	WP-1043	4,75	106	106	2300	WP-106	4,75
105D	116X	530	WP-1125	4,75	106	106	2400	WP-116	4,75
105D	116X	3200	WP-1533	4,75	106	106	2700	WP-1735	4,75
105X	106	2400	WP-1875	4,75	106	106	2950	WP-1709	4,75
105X	116X	1250	WP-475	4,75	106	106	3000	WP-516	4,75
106	105A	140	WP-998	4,75	106	106	3100	WP-564	4,75
106	105A	180	WP-1008	4,75	106	106	3170	WP-1528	4,75
106	105A	240	WP-1020	4,75	106	106	3200	WP-454	4,75
106	105A	250	WP-1022	4,75	106	107	200	WP-914	4,75
106	105A	290	WP-1036	4,75	106	109	500	WP-189	4,75
106	105A	305	WP-1044	4,75	106	116	2800	WP-915	4,75
106	105A	325	WP-1051	4,75	107	105A	510	WP-1117	4,75
106	105A	350	WP-1061	4,75	107	105A	620	WP-1153	4,75
106	105A	380	WP-1072	4,75	107	105A	680	WP-1170	4,75
106	105A	400	WP-1078	4,75	107	105A	760	WP-1197	4,75
106	105A	450	WP-1094	4,75	107	105A	970	WP-1252	4,75
106	105A	510	WP-1116	4,75	107	105A	3200	WP-1531	4,75
106	105A	620	WP-1152	4,75	107	107	630	WP-1642	4,75
106	105A	640	WP-1158	4,75	107	107	1250	WP-1643	4,75
106	105A	660	WP-1164	4,75	107	116	200	WP-574	4,75
106	105A	690	WP-1174	4,75	108	105A	260	WP-1027	4,75
106	105A	725	WP-1184	4,75	108	105A	300	WP-1042	4,75
106	105A	780	WP-1201	4,75	108	105A	360	WP-1064	4,75
106	105A	830	WP-1213	4,75	108	105A	440	WP-1092	4,75
106	105A	850	WP-1219	4,75	108	105A	460	WP-1097	4,75
106	105A	900	WP-1233	4,75	108	105A	960	WP-1248	4,75
106	105A	950	WP-1244	4,75	108	105A	1020	WP-1265	4,75
106	105A	990	WP-1258	4,75	108	105A	1170	WP-1302	4,75
106	105A	1050	WP-1277	4,75	108	108	2150	WP-1692	4,75
106	105A	1100	WP-1287	4,75	108	116	2050	WP-1693	4,75
106	105A	1150	WP-1299	4,75	108	116	2850	WP-1694	4,75
106	105A	1240	WP-1314	4,75	108	116	3250	WP-1695	4,75
106	105A	1290	WP-1326	4,75	109	109	150	WP-286	4,75
106	105A	1350	WP-1334	4,75	109	109	200	WP-317	4,75
106	105A	1390	WP-1342	4,75	109	109	230	WP-1018	4,75
106	105A	1500	WP-1361	4,75	109	109	250	WP-764	4,75
106	105A	1540	WP-1365	4,75	109	109	300	WP-298	4,75
106	105A	1590	WP-1375	4,75	109	109	350	WP-322	4,75
106	105A	1690	WP-1388	4,75	109	109	390	WP-1076	4,75
106	105A	1740	WP-1394	4,75	109	109	400	WP-402	4,75
106	105A	1850	WP-1405	4,75	109	109	430	WP-1089	4,75
106	105A	1900	WP-1413	4,75	109	109	440	WP-1093	4,75

ZŁĄCZKA FITTING НАКОНЕЧНИК	ZŁĄCZKA FITTING НАКОНЕЧНИК	DŁUGOŚĆ W MM LENGHT IN MM ДЛИНА В MM	INDEKS INDEX ИНДЕКС	ŚREDNICA RURY DIAMETER ДИАМЕТР ТРУБЫ	ZŁĄCZKA FITTING НАКОНЕЧНИК	ZŁĄCZKA FITTING НАКОНЕЧНИК	DŁUGOŚĆ W MM LENGHT IN MM ДЛИНА В MM	INDEKS INDEX ИНДЕКС	ŚREDNICA RURY DIAMETER ДИАМЕТР ТРУБЫ
109	109	450	WP-058	4,75	109	110	1200	WP-094	4,75
109	109	500	WP-407	4,75	109	110	1225	WP-1312	4,75
109	109	600	WP-287	4,75	109	110	1250	WP-770	4,75
109	109	700	WP-296	4,75	109	110	1260	WP-1322	4,75
109	109	740	WP-1187	4,75	109	110	1300	WP-177	4,75
109	109	750	WP-300	4,75	109	110	1350	WP-076	4,75
109	109	765	WP-1199	4,75	109	110	1450	WP-325	4,75
109	109	800	WP-065	4,75	109	110	1500	WP-072	4,75
109	109	900	WP-319	4,75	109	110	1600	WP-320	4,75
109	109	930	WP-1239	4,75	109	110	1740	WP-1395	4,75
109	109	950	WP-293	4,75	109	110	1750	WP-077	4,75
109	109	1000	WP-321	4,75	109	110	1850	WP-332	4,75
109	109	1060	WP-1280	4,75	109	110	1950	WP-318	4,75
109	109	1100	WP-057	4,75	109	110	2050	WP-771	4,75
109	109	1150	WP-301	4,75	109	110	2200	WP-326	4,75
109	109	1200	WP-327	4,75	109	110	2300	WP-096	4,75
109	109	1300	WP-179	4,75	109	110	2400	WP-324	4,75
109	109	1400	WP-079	4,75	109	110	2450	WP-772	4,75
109	109	1440	WP-1352	4,75	109	110	2500	WP-067	4,75
109	109	1450	WP-305	4,75	109	110	2570	WP-1474	4,75
109	109	1500	WP-336	4,75	109	110	2600	WP-773	4,75
109	109	1540	WP-1366	4,75	109	110	2800	WP-181	4,75
109	109	1550	WP-285	4,75	109	110	2920	WP-1501	4,75
109	109	1700	WP-075	4,75	109	110	2950	WP-774	4,75
109	109	1800	WP-302	4,75	109	110	3000	WP-173	4,75
109	109	1900	WP-330	4,75	109	110	3050	WP-775	4,75
109	109	1930	WP-1416	4,75	109	110	3200	WP-170	4,75
109	109	1950	WP-294	4,75	109	110	3240	WP-1538	4,75
109	109	2020	WP-1427	4,75	109	110	3250	WP-776	4,75
109	109	2050	WP-765	4,75	109	110	3300	WP-080	4,75
109	109	2080	WP-1438	4,75	109	110	3500	WP-083	4,75
109	109	2100	WP-297	4,75	109	110	3600	WP-184	4,75
109	109	2200	WP-329	4,75	109	111	290	WP-1038	4,75
109	109	2500	WP-986	4,75	109	111	300	WP-370	4,75
109	109	2550	WP-766	4,75	109	111	700	WP-373	4,75
109	109	2600	WP-062	4,75	109	111	800	WP-371	4,75
109	109	2650	WP-767	4,75	109	111	950	WP-372	4,75
109	109	2760	WP-1490	4,75	109	114	410	WP-1084	4,75
109	109	2800	WP-288	4,75	109	114	450	WP-066	4,75
109	109	2870	WP-1497	4,75	109	114	950	WP-289	4,75
109	109	2900	WP-291	4,75	109	114	1950	WP-290	4,75
109	109	2960	WP-1509	4,75	109	114	2600	WP-069	4,75
109	109	3000	WP-292	4,75	109	114	2930	WP-1502	4,75
109	109	3200	WP-087	4,75	109	114	2950	WP-777	4,75
109	109	3300	WP-299	4,75	109	114	3000	WP-295	4,75
109	109	3400	WP-768	4,75	109	114	3050	WP-778	4,75
109	109	3500	WP-304	4,75	109	114	3100	WP-071	4,75
109	109	3510	WP-1558	4,75	109	114	3150	WP-779	4,75
109	109	3550	WP-769	4,75	109	114	3600	WP-306	4,75
109	109	3600	WP-311	4,75	109	115	300	WP-279	4,75
109	110	140	WP-1000	4,75	110	105A	140	WP-999	4,75
109	110	150	WP-060	4,75	110	105A	250	WP-1023	4,75
109	110	190	WP-1011	4,75	110	110	195	WP-1012	4,75
109	110	200	WP-064	4,75	110	110	200	WP-780	4,75
109	110	250	WP-169	4,75	110	110	510	WP-1858	4,75
109	110	260	WP-1030	4,75	110	110	2000	WP-1859	4,75
109	110	295	WP-1040	4,75	110	110	2250	WP-781	4,75
109	110	300	WP-061	4,75	110	110	2300	WP-182	4,75
109	110	320	WP-975	4,75	110	114	250	WP-171	4,75
109	110	350	WP-178	4,75	110	114	300	WP-335	4,75
109	110	400	WP-180	4,75	110	114	350	WP-782	4,75
109	110	450	WP-085	4,75	110	114	740	WP-1189	4,75
109	110	500	WP-333	4,75	110	114	750	WP-099	4,75
109	110	540	WP-1130	4,75	110	114	845	WP-1218	4,75
109	110	550	WP-073	4,75	110	114	850	WP-082	4,75
109	110	580	WP-1145	4,75	110	114	940	WP-1242	4,75
109	110	600	WP-095	4,75	110	114	950	WP-783	4,75
109	110	640	WP-1160	4,75	110	114	1200	WP-185	4,75
109	110	650	WP-059	4,75	110	114	1375	WP-1340	4,75
109	110	700	WP-063	4,75	110	114	1400	WP-081	4,75
109	110	710	WP-1182	4,75	110	114	1500	WP-172	4,75
109	110	750	WP-086	4,75	110	114	1730	WP-1393	4,75
109	110	790	WP-1204	4,75	110	114	1750	WP-334	4,75
109	110	800	WP-078	4,75	110	114	2690	WP-1483	4,75
109	110	840	WP-1216	4,75	110	114	2700	WP-784	4,75
109	110	850	WP-097	4,75	110	114	2950	WP-785	4,75
109	110	890	WP-1230	4,75	110	114	3000	WP-068	4,75
109	110	900	WP-084	4,75	110X	110X	2100	WP-508	4,75
109	110	950	WP-323	4,75	110X	110X	2150	WP-1702	4,75
109	110	970	WP-1253	4,75	110X	110X	2250	WP-1703	4,75
109	110	1000	WP-098	4,75	111	111	240	WP-1021	4,75
109	110	1100	WP-074	4,75	111	111	250	WP-375	4,75
109	110	1150	WP-183	4,75	111	115	270	WP-1031	4,75

ZŁĄCZKA FITTING НАКОНЕЧНИК		ZŁĄCZKA FITTING НАКОНЕЧНИК		DŁUGOŚĆ W MM LENGHT IN MM ДЛИНА В MM		INDEKS INDEX ИНДЕКС		ŚREDNICA RURY DIAMETER ДИАМЕТР ТРУБЫ		ZŁĄCZKA FITTING НАКОНЕЧНИК		ZŁĄCZKA FITTING НАКОНЕЧНИК		DŁUGOŚĆ W MM LENGHT IN MM ДЛИНА В MM		INDEKS INDEX ИНДЕКС		ŚREDNICA RURY DIAMETER ДИАМЕТР ТРУБЫ	
																			
						WP- 001		4,75								WP- 001		4,75	
111	115	300	WP-360	4,75	112	112	1300	WP-422	4,75										
111	115	340	WP-1058	4,75	112	112	1350	WP-1666	4,75										
111	115	350	WP-359	4,75	112	112	1370	WP-1338	4,75										
111	115	360	WP-1065	4,75	112	112	1400	WP-165	4,75										
111	115	400	WP-376	4,75	112	112	1440	WP-1353	4,75										
111	115	480	WP-1107	4,75	112	112	1450	WP-163	4,75										
111	115	500	WP-362	4,75	112	112	1500	WP-551	4,75										
111	115	525	WP-1123	4,75	112	112	1530	WP-1620	4,75										
111	115	550	WP-378	4,75	112	112	1570	WP-1371	4,75										
111	115	690	WP-1177	4,75	112	112	1600	WP-168	4,75										
111	115	700	WP-374	4,75	112	112	1630	WP-1621	4,75										
111	115	760	WP-1198	4,75	112	112	1665	WP-1385	4,75										
111	115	800	WP-361	4,75	112	112	1670	WP-1896	4,75										
111	115	850	WP-383	4,75	112	112	1690	WP-1389	4,75										
111	115	900	WP-382	4,75	112	112	1700	WP-156	4,75										
111	115	950	WP-363	4,75	112	112	1750	WP-409	4,75										
111	115	1020	WP-1271	4,75	112	112	1800	WP-466	4,75										
111	115	1050	WP-377	4,75	112	112	1815	WP-1934	4,75										
111	115	1090	WP-1284	4,75	112	112	1850	WP-227	4,75										
111	115	1100	WP-381	4,75	112	112	2000	WP-553	4,75										
111	115	1680	WP-1386	4,75	112	112	2100	WP-055	4,75										
111	115	1700	WP-379	4,75	112	112	2200	WP-1665	4,75										
111	115	1840	WP-1404	4,75	112	112	2300	WP-164	4,75										
111	115	1850	WP-380	4,75	112	112	2335	WP-1935	4,75										
112	105A	570	WP-1138	4,75	112	112	2350	WP-788	4,75										
112	105A	690	WP-1175	4,75	112	112	2400	WP-161	4,75										
112	105A	1020	WP-1266	4,75	112	112	2500	WP-469	4,75										
112	105A	1140	WP-1295	4,75	112	112	2800	WP-789	4,75										
112	105A	1320	WP-1329	4,75	112	112	2820	WP-1494	4,75										
112	105A	1975	WP-1423	4,75	112	112	2850	WP-470	4,75										
112	105A	3770	WP-1575	4,75	112	112	2980	WP-992	4,75										
112	112	150	WP-575	4,75	112	112	3000	WP-157	4,75										
112	112	170	WP-1721	4,75	112	112	3080	WP-1520	4,75										
112	112	190	WP-1884	4,75	112	112	3100	WP-226	4,75										
112	112	200	WP-1893	4,75	112	112	3200	WP-790	4,75										
112	112	210	WP-1909	4,75	112	112	3220	WP-1535	4,75										
112	112	220	WP-1015	4,75	112	112	3250	WP-791	4,75										
112	112	250	WP-229	4,75	112	112	3280	WP-1542	4,75										
112	112	260	WP-973	4,75	112	112	3300	WP-166	4,75										
112	112	300	WP-056	4,75	112	112	3370	WP-1546	4,75										
112	112	320	WP-1663	4,75	112	112	3400	WP-792	4,75										
112	112	330	WP-1055	4,75	112	112	3450	WP-1885	4,75										
112	112	340	WP-1931	4,75	112	112	3500	WP-155	4,75										
112	112	350	WP-151	4,75	112	112	3600	WP-158	4,75										
112	112	375	WP-1069	4,75	112	112	3700	WP-413	4,75										
112	112	380	WP-1664	4,75	112	112	4100	WP-467	4,75										
112	112	390	WP-1932	4,75	112	112	4350	WP-468	4,75										
112	112	400	WP-150	4,75	112	113	420	WP-1921	4,75										
112	112	420	WP-1894	4,75	112	113	430	WP-1922	4,75										
112	112	430	WP-1090	4,75	112	113	470	WP-1923	4,75										
112	112	440	WP-1895	4,75	112	113	580	WP-1924	4,75										
112	112	450	WP-162	4,75	112	113	810	WP-1925	4,75										
112	112	460	WP-1099	4,75	112	113	820	WP-1926	4,75										
112	112	480	WP-1106	4,75	112	113	1680	WP-1927	4,75										
112	112	500	WP-053	4,75	112	113	1815	WP-1928	4,75										
112	112	520	WP-1121	4,75	113	113	160	WP-1004	4,75										
112	112	550	WP-051	4,75	113	113	200	WP-246	4,75										
112	112	580	WP-1933	4,75	113	113	300	WP-237	4,75										
112	112	600	WP-412	4,75	113	113	320	WP-1050	4,75										
112	112	610	WP-991	4,75	113	113	350	WP-238	4,75										
112	112	640	WP-1161	4,75	113	113	400	WP-793	4,75										
112	112	650	WP-153	4,75	113	113	450	WP-243	4,75										
112	112	700	WP-787	4,75	113	113	460	WP-1100	4,75										
112	112	740	WP-1188	4,75	113	113	500	WP-794	4,75										
112	112	750	WP-228	4,75	113	113	540	WP-1131	4,75										
112	112	755	WP-1195	4,75	113	113	550	WP-234	4,75										
112	112	800	WP-411	4,75	113	113	560	WP-1929	4,75										
112	112	820	WP-1722	4,75	113	113	610	WP-1930	4,75										
112	112	830	WP-1908	4,75	113	113	650	WP-240	4,75										
112	112	850	WP-159	4,75	113	113	685	WP-1173	4,75										
112	112	865	WP-1226	4,75	113	113	700	WP-230	4,75										
112	112	900	WP-054	4,75	113	113	840	WP-1217	4,75										
112	112	950	WP-154	4,75	113	113	850	WP-233	4,75										
112	112	1000	WP-410	4,75	113	113	900	WP-795	4,75										
112	112	1020	WP-1269	4,75	113	113	985	WP-1257	4,75										
112	112	1050	WP-052	4,75	113	113	1000	WP-244	4,75										
112	112	1070	WP-993	4,75	113	113	1020	WP-1270	4,75										
112	112	1100	WP-149	4,75	113	113	1050	WP-242	4,75										
112	112	1120	WP-974	4,75	113	113	1090	WP-1283	4,75										
112	112	1150	WP-160	4,75	113	113	1100	WP-231	4,75										
112	112	1200	WP-421	4,75	113	113	1110	WP-1292	4,75										
112	112	1225	WP-1313	4,75	113	113	1150	WP-796	4,75										
112	112	1250	WP-152	4,75	113	113	1170	WP-1303	4,75										

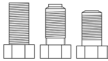
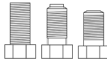
ZŁĄCZKA FITTING НАКОНЕЧНИК	ZŁĄCZKA FITTING НАКОНЕЧНИК	DŁUGOŚĆ W MM LENGHT IN MM ДЛИНА В MM	INDEKS INDEX ИНДЕКС	ŚREDNICA RURY DIAMETER ДИАМЕТР ТРУБЫ	ZŁĄCZKA FITTING НАКОНЕЧНИК	ZŁĄCZKA FITTING НАКОНЕЧНИК	DŁUGOŚĆ W MM LENGHT IN MM ДЛИНА В MM	INDEKS INDEX ИНДЕКС	ŚREDNICA RURY DIAMETER ДИАМЕТР ТРУБЫ
113	113	1200	WP-239	4,75	116	105D	1140	WP-1297	4,75
113	113	1400	WP-797	4,75	116	105D	1200	WP-1308	4,75
113	113	1500	WP-798	4,75	116	105D	1260	WP-1321	4,75
113	113	1570	WP-1372	4,75	116	105D	1300	WP-1328	4,75
113	113	1600	WP-248	4,75	116	105D	1350	WP-1336	4,75
113	113	1950	WP-247	4,75	116	105D	1420	WP-1347	4,75
113	113	2350	WP-799	4,75	116	105D	1450	WP-1355	4,75
113	113	2400	WP-241	4,75	116	105D	1860	WP-1407	4,75
113	113	2600	WP-245	4,75	116	105D	1940	WP-1419	4,75
113	113	2800	WP-800	4,75	116	105D	2050	WP-1431	4,75
113	113	2900	WP-249	4,75	116	105D	2120	WP-1442	4,75
113	113	3000	WP-232	4,75	116	105D	2950	WP-1508	4,75
113	113	3200	WP-916	4,75	116	105D	3000	WP-1516	4,75
113	113	4200	WP-801	4,75	116	105D	3100	WP-1523	4,75
113	113	4300	WP-802	4,75	116	105D	3220	WP-1534	4,75
114	114	600	WP-1649	4,75	116	105D	3400	WP-1550	4,75
114	115	700	WP-1629	4,75	116	105D	3450	WP-1553	4,75
114	115	2300	WP-281	4,75	116	105D	3480	WP-1554	4,75
115	110X	100	WP-1887	4,75	116	105D	3560	WP-1561	4,75
115	115	200	WP-369	4,75	116	105D	3600	WP-1565	4,75
115	115	250	WP-341	4,75	116	105D	3650	WP-1567	4,75
115	115	330	WP-1056	4,75	116	105D	3760	WP-1574	4,75
115	115	350	WP-272	4,75	116	105D	4250	WP-1595	4,75
115	115	375	WP-1070	4,75	116	105D	4380	WP-1600	4,75
115	115	400	WP-269	4,75	116	105D	4410	WP-1603	4,75
115	115	420	WP-1652	4,75	116	105D	4550	WP-1607	4,75
115	115	450	WP-282	4,75	116	105D	4570	WP-1608	4,75
115	115	490	WP-1111	4,75	116	105D	4750	WP-1611	4,75
115	115	500	WP-270	4,75	116	105X	1200	WP-1876	4,75
115	115	550	WP-342	4,75	116	105X	1250	WP-1877	4,75
115	115	600	WP-273	4,75	116	116	115	WP-951	4,75
115	115	650	WP-277	4,75	116	116	130	WP-952	4,75
115	115	700	WP-340	4,75	116	116	150	WP-135	4,75
115	115	740	WP-1190	4,75	116	116	165	WP-1005	4,75
115	115	750	WP-278	4,75	116	116	180	WP-1010	4,75
115	115	800	WP-367	4,75	116	116	200	WP-070	4,75
115	115	890	WP-1231	4,75	116	116	210	WP-953	4,75
115	115	900	WP-267	4,75	116	116	230	WP-954	4,75
115	115	930	WP-1240	4,75	116	116	250	WP-130	4,75
115	115	950	WP-280	4,75	116	116	255	WP-1024	4,75
115	115	1000	WP-366	4,75	116	116	270	WP-955	4,75
115	115	1040	WP-1276	4,75	116	116	280	WP-1034	4,75
115	115	1050	WP-275	4,75	116	116	300	WP-118	4,75
115	115	1100	WP-368	4,75	116	116	310	WP-1046	4,75
115	115	1300	WP-268	4,75	116	116	340	WP-1059	4,75
115	115	1550	WP-345	4,75	116	116	350	WP-138	4,75
115	115	1850	WP-271	4,75	116	116	380	WP-956	4,75
115	115	2200	WP-344	4,75	116	116	400	WP-144	4,75
115	115	2260	WP-1456	4,75	116	116	430	WP-957	4,75
115	115	2300	WP-276	4,75	116	116	450	WP-123	4,75
115	115	2500	WP-274	4,75	116	116	460	WP-1101	4,75
115	115	2555	WP-1473	4,75	116	116	480	WP-958	4,75
115	115	2600	WP-803	4,75	116	116	500	WP-134	4,75
115	115	2650	WP-804	4,75	116	116	520	WP-1122	4,75
115	115	2700	WP-343	4,75	116	116	530	WP-1126	4,75
115	115	2800	WP-364	4,75	116	116	540	WP-1132	4,75
115	115	2950	WP-805	4,75	116	116	550	WP-120	4,75
115	115	3000	WP-365	4,75	116	116	580	WP-994	4,75
116	105A	330	WP-1053	4,75	116	116	600	WP-141	4,75
116	105A	470	WP-1102	4,75	116	116	630	WP-1157	4,75
116	105A	1020	WP-1268	4,75	116	116	640	WP-1162	4,75
116	105A	1220	WP-1311	4,75	116	116	650	WP-431	4,75
116	105D	150	WP-1002	4,75	116	116	660	WP-1166	4,75
116	105D	230	WP-1017	4,75	116	116	680	WP-1172	4,75
116	105D	260	WP-1029	4,75	116	116	700	WP-131	4,75
116	105D	280	WP-1033	4,75	116	116	735	WP-1185	4,75
116	105D	320	WP-1049	4,75	116	116	750	WP-125	4,75
116	105D	330	WP-1054	4,75	116	116	780	WP-959	4,75
116	105D	365	WP-1066	4,75	116	116	800	WP-148	4,75
116	105D	370	WP-1068	4,75	116	116	810	WP-1208	4,75
116	105D	400	WP-1080	4,75	116	116	840	WP-960	4,75
116	105D	480	WP-1105	4,75	116	116	850	WP-136	4,75
116	105D	510	WP-1118	4,75	116	116	870	WP-1227	4,75
116	105D	660	WP-1165	4,75	116	116	900	WP-126	4,75
116	105D	750	WP-1194	4,75	116	116	940	WP-1243	4,75
116	105D	820	WP-1212	4,75	116	116	950	WP-119	4,75
116	105D	860	WP-1225	4,75	116	116	960	WP-1251	4,75
116	105D	880	WP-1229	4,75	116	116	1000	WP-429	4,75
116	105D	920	WP-1238	4,75	116	116	1010	WP-961	4,75
116	105D	950	WP-1246	4,75	116	116	1030	WP-1272	4,75
116	105D	960	WP-1250	4,75	116	116	1050	WP-132	4,75
116	105D	1070	WP-1281	4,75	116	116	1070	WP-1282	4,75
116	105D	1100	WP-1290	4,75	116	116	1090	WP-1285	4,75

ZŁĄCZKA FITTING НАКОНЕЧНИК	ZŁĄCZKA FITTING НАКОНЕЧНИК	DŁUGOŚĆ W MM LENGHT IN MM ДЛИНА В MM	INDEKS INDEX ИНДЕКС	ŚREDNICA RURY DIAMETER ДИАМЕТР ТРУБЫ	ZŁĄCZKA FITTING НАКОНЕЧНИК	ZŁĄCZKA FITTING НАКОНЕЧНИК	DŁUGOŚĆ W MM LENGHT IN MM ДЛИНА В MM	INDEKS INDEX ИНДЕКС	ŚREDNICA RURY DIAMETER ДИАМЕТР ТРУБЫ
									
116	116	1100	WP-133	4,75	116	116	4080	WP-1590	4,75
116	116	1120	WP-1294	4,75	116	116	4100	WP-219	4,75
116	116	1150	WP-809	4,75	116	116	4150	WP-568	4,75
116	116	1160	WP-1301	4,75	116	116	4200	WP-430	4,75
116	116	1200	WP-129	4,75	116	116	4300	WP-827	4,75
116	116	1240	WP-1317	4,75	116	116	4350	WP-1737	4,75
116	116	1250	WP-810	4,75	116	116	4400	WP-828	4,75
116	116	1300	WP-917	4,75	116	116	4450	WP-919	4,75
116	116	1310	WP-962	4,75	116	116	4500	WP-570	4,75
116	116	1350	WP-124	4,75	116	116	4600	WP-1710	4,75
116	116	1400	WP-581	4,75	116	116	4750	WP-920	4,75
116	116	1430	WP-1350	4,75	116	116	5650	WP-1440	4,75
116	116	1450	WP-224	4,75	116	116	5700	WP-450	4,75
116	116	1500	WP-140	4,75	116	116X	150	WP-925	4,75
116	116	1540	WP-1367	4,75	116	116X	200	WP-849	4,75
116	116	1550	WP-223	4,75	116	116X	255	WP-1025	4,75
116	116	1580	WP-1374	4,75	116	116X	300	WP-406	4,75
116	116	1600	WP-251	4,75	116	116X	400	WP-850	4,75
116	116	1610	WP-1378	4,75	116	116X	450	WP-851	4,75
116	116	1650	WP-222	4,75	116	116X	500	WP-852	4,75
116	116	1680	WP-1387	4,75	116	116X	550	WP-853	4,75
116	116	1700	WP-220	4,75	116	116X	1000	WP-854	4,75
116	116	1740	WP-1396	4,75	116	116X	1050	WP-926	4,75
116	116	1750	WP-812	4,75	116	116X	1100	WP-855	4,75
116	116	1800	WP-218	4,75	116	116X	1200	WP-1878	4,75
116	116	1850	WP-145	4,75	116	116X	1260	WP-1323	4,75
116	116	1870	WP-1408	4,75	116	116X	1300	WP-856	4,75
116	116	1890	WP-1411	4,75	116	116X	1630	WP-1381	4,75
116	116	1900	WP-250	4,75	116	116X	1650	WP-857	4,75
116	116	1910	WP-1415	4,75	116	116X	1850	WP-858	4,75
116	116	1940	WP-1420	4,75	116	116X	2230	WP-1451	4,75
116	116	1950	WP-813	4,75	116	116X	2250	WP-859	4,75
116	116	2000	WP-147	4,75	116	116X	2480	WP-1467	4,75
116	116	2030	WP-1428	4,75	116	116X	2500	WP-860	4,75
116	116	2050	WP-814	4,75	116	116X	2570	WP-1475	4,75
116	116	2060	WP-1433	4,75	116	116X	2600	WP-861	4,75
116	116	2100	WP-146	4,75	116	116X	2650	WP-1879	4,75
116	116	2150	WP-815	4,75	116	116X	3250	WP-1880	4,75
116	116	2200	WP-235	4,75	116	116X	3380	WP-1547	4,75
116	116	2230	WP-1450	4,75	116	116X	3400	WP-862	4,75
116	116	2250	WP-816	4,75	116	116X	3660	WP-1568	4,75
116	116	2300	WP-100	4,75	116	116X	3700	WP-863	4,75
116	116	2310	WP-1459	4,75	116	116X	3970	WP-1584	4,75
116	116	2350	WP-817	4,75	116	116X	4000	WP-864	4,75
116	116	2400	WP-137	4,75	116	116X	4200	WP-865	4,75
116	116	2500	WP-142	4,75	116	116X	4370	WP-1599	4,75
116	116	2530	WP-1471	4,75	116	116X	4400	WP-866	4,75
116	116	2550	WP-818	4,75	116	116X	4430	WP-1605	4,75
116	116	2600	WP-127	4,75	116	116X	4450	WP-867	4,75
116	116	2670	WP-1481	4,75	116	116X	4500	WP-868	4,75
116	116	2700	WP-819	4,75	116	118	200	WP-988	4,75
116	116	2800	WP-121	4,75	116	118	500	WP-987	4,75
116	116	2850	WP-509	4,75	118	118	650	WP-426	4,75
116	116	2930	WP-1503	4,75	118	118	750	WP-423	4,75
116	116	2950	WP-820	4,75	118	118	1050	WP-425	4,75
116	116	3000	WP-821	4,75	118	118	1300	WP-424	4,75
116	116	3020	WP-1637	4,75	118	118	3700	WP-427	4,75
116	116	3050	WP-822	4,75	119	119	1000	WP-635	6,35
116	116	3100	WP-139	4,75	119	119	1500	WP-636	6,35
116	116	3150	WP-1736	4,75	119	119	2000	WP-637	6,35
116	116	3160	WP-1527	4,75	119	119	2500	WP-638	6,35
116	116	3200	WP-236	4,75	120	120	201	WP-2988B	3,50
116	116	3220	WP-1536	4,75	120	120	230	WP-1904	3,50
116	116	3250	WP-823	4,75	120	120	240	WP-1903	3,50
116	116	3300	WP-143	4,75	120	120	250	WP-1824	3,50
116	116	3330	WP-963	4,75	120	120	271	WP-2988A	3,50
116	116	3350	WP-824	4,75	120	120	310	WP-1847	3,50
116	116	3450	WP-825	4,75	120	120	330	WP-1987	3,50
116	116	3500	WP-221	4,75	120	120	335	WP-2970	3,50
116	116	3550	WP-567	4,75	120	120	340	WP-1857	3,50
116	116	3600	WP-128	4,75	120	120	345	WP-1913	3,50
116	116	3660	WP-964	4,75	120	120	350	WP-1914	3,50
116	116	3700	WP-122	4,75	120	120	360	WP-1991	3,50
116	116	3750	WP-918	4,75	120	120	391	WP-2971A	3,50
116	116	3770	WP-1576	4,75	120	120	399	WP-2987	3,50
116	116	3800	WP-449	4,75	120	120	425	WP-1970	3,50
116	116	3870	WP-1579	4,75	120	120	425	WP-1990	3,50
116	116	3900	WP-225	4,75	120	120	440	WP-1907	3,50
116	116	3930	WP-965	4,75	120	120	440	WP-2988	3,50
116	116	3950	WP-826	4,75	120	120	460	WP-1981	3,50
116	116	4000	WP-434	4,75	120	120	465	WP-1838	3,50
116	116	4030	WP-1587	4,75	120	120	505	WP-1973	3,50
116	116	4050	WP-569	4,75	120	120	510	WP-1833	3,50

ZŁĄCZKA FITTING НАКОНЕЧНИК	ZŁĄCZKA FITTING НАКОНЕЧНИК	DŁUGOŚĆ W MM LENGHT IN MM ДЛИНА В MM	INDEKS INDEX ИНДЕКС	ŚREDNICA RURY DIAMETER ДИАМЕТР ТРУБЫ	ZŁĄCZKA FITTING НАКОНЕЧНИК	ZŁĄCZKA FITTING НАКОНЕЧНИК	DŁUGOŚĆ W MM LENGHT IN MM ДЛИНА В MM	INDEKS INDEX ИНДЕКС	ŚREDNICA RURY DIAMETER ДИАМЕТР ТРУБЫ
									
120	120	541	WP-2990	3,50	120	120	3205	WP-1982	3,50
120	120	568	WP-2980	3,50	120	120	3300	WP- 1842a	3,50
120	120	586	WP-2977	3,50	120	120	3420	WP-1979	3,50
120	120	595	WP-1846	3,50	120	120	3450	WP- 1839a	3,50
120	120	630	WP-1971	3,50	120	120	3690	WP-2982	3,50
120	120	750	WP-1985	3,50	120	120	3763	WP-2989	3,50
120	120	792	WP-2971	3,50	120	120	3785	WP-1989	3,50
120	120	830	WP-1998	3,50	120	120	3985	WP-2979	3,50
120	120	830	WP-1998C	3,50	160	160	230	WP-1853	4,50
120	120	865	WP-1986	3,50	160	160	240	WP-2001	4,50
120	120	925	WP-2981	3,50	160	160	250	WP-1826	4,50
120	120	940	WP-1845	3,50	160	160	300	WP-1995	4,50
120	120	945	WP-1980	3,50	160	160	350	WP-1825	4,50
120	120	951	WP-2985	3,50	160	160	360	WP-1854	4,50
120	120	955	WP-1831	3,50	160	160	500	WP-1852	4,50
120	120	1006	WP-2981B	3,50	160	160	580	WP-2000	4,50
120	120	1020	WP-2983	3,50	160	160	630	WP-1829	4,50
120	120	1085	WP-1836	3,50	160	160	660	WP-1855	4,50
120	120	1085	WP-2986	3,50	160	160	750	WP-1998E	4,50
120	120	1100	WP-1834C	3,50	160	160	750	WP-1998F	4,50
120	120	1110	WP-1974	3,50	160	160	775	WP-1998D	4,50
120	120	1147	WP-2981A	3,50	160	160	820	WP-1993	4,50
120	120	1200	WP-1818	3,50	160	160	930	WP-1828	4,50
120	120	1250	WP-1819	3,50	160	160	940	WP-1999	4,50
120	120	1300	WP-1820	3,50	160	160	1045	WP-1830	4,50
120	120	1350	WP-1820	3,50	160	160	1240	WP-1837	4,50
120	120	1385	WP-1984	3,50	160	160	1250	WP-1840	4,50
120	120	1400	WP-1822	3,50	160	160	1305	WP-1841	4,50
120	120	1500	WP-1901	3,50	160	160	1370	WP-1843	4,50
120	120	1600	WP-1911	3,50	160	160	1410	WP-1844	4,50
120	120	1650	WP-1823	3,50	160	160	1470	WP-1848	4,50
120	120	1800	WP-1975	3,50	160	160	1480	WP-1850	4,50
120	120	1938	WP-2975	3,50	160	160	1510	WP-1851	4,50
120	120	1955	WP-1983	3,50	160	160	1665	WP-1994	4,50
120	120	1960	WP-1835Y	3,50	160	160	1940	WP-2003	4,50
120	120	1980	WP-1836Y	3,50	160	160	2470	WP-2002	4,50
120	120	2200	WP-1976	3,50	160	160	2200	WP-1996	4,50
120	120	2201	WP-2984	3,50	160	160	2500	WP-1827	4,50
120	120	2400	WP-1912	3,50	160	160	3307	WP-2992	4,50
120	120	2450	WP-1902	3,50	160	160	3320	WP-1992	4,50
120	120	2462	WP-2976	3,50	160	160	4000	WP-1997	4,50
120	120	2530	WP-1906	3,50	161	161	800	WP-650	6,35
120	120	2570	WP-1905	3,50	161	161	1000	WP-651	6,35
120	120	2635	WP-1832	3,50	161	161	1200	WP-652	6,35
120	120	2800	WP-1915	3,50	161	161	1250	WP-653	6,35
120	120	2820	WP-1849	3,50	161	161	1300	WP-654	6,35
120	120	2900	WP-1856	3,50	161	161	1350	WP-655	6,35
120	120	2970	WP-1842	3,50	161	161	1550	WP-656	6,35
120	120	3050	WP-1972	3,50	161	161	1600	WP-657	6,35
120	120	3100	WP-1979C	3,50	161	161	650	WP-658	6,35
120	120	3185	WP-1839	3,50	161	161	450	WP-659	6,35





Kontakt/contact/контакты :

Przedsiębiorstwo "WP"
ul.Miedziana 8,
05-830 Kajetany,
Poland

e-mail: wp@pwpnet.pl
tel: +48 22 758 68 92